

# LINDNER

*Das Original*



## Collectors Accessories of Distinction

**COMPLETE CATALOG**

English | Effective 01.02.2026

# LINDNER

*Das Original*



Husband and wife partners Elena Lindner and Frank Wenger, owners and managing directors in 4th generation.



LINDNER Headquarter in Schömburg in the 50s.



Headquarter in Schömburg, Zollernalbkreis.

LINDNER at your service since 1947 - over 75 years of experience for the best possible storing solutions for collections worldwide.

## THE TASK...

As a collector of stamps, coins, medals, banknotes and other objects you have taken on the rewarding task of safeguarding objects that may have monetary, personal or cultural significance. Through this you are documenting the present and the past in a very special format.

At LINDNER we have made it our primary mission to support you in your passion with our collecting systems. Whether your passion is to collect objects to preserve or enhance the value, or to research and develop a collecting theme, the presentation and storage of your collection is a fundamental part of your passion. The LINDNER product portfolio offers a wide range of possibilities and essential accessories to aid you in your hobby.

## THE ESTABLISHMENT...

In 1947 August Lindner began to develop products for collectors and over the following years continued to expand these. What started as a small company with only a few products and co-workers has developed into a mid-sized global business with a considerable product range and variety; committed to unholding tradition and also innovating new ideas. The first coin album available in Germany is still a treasured LINDNER product to this very day. The hingeless (falzlos) system, the T-products and last but not least, the LINDNER coin boxes, are all inventions “Made by LINDNER” which have found their place in the world of collecting. The continual enhancing of the portfolio by working together with collectors and dealers a-like, has made LINDNER a household name in collector’s circles.

In 2006, just about 60 years after the company’s founding, the families 4th generation took over the management of the LINDNER business and is now leading this internationally established enterprise in its unchanged title. Our primary commitment is still offering high-quality, safe, beautiful and practical conservation of collector’s objects. Since its founding, the company’s headquarter is in Schömburg near Balingen in the Zollernalbkreis. Through a network of domestic and foreign dealers and distributors, we are represented nationally and internationally, enabling us to offer our products worldwide.

## THE CLAIM...

Our principal goal to support you in your collector’s passion is assured through our high-quality standards. We see quality control in production and deliveries as a responsibility and self-evident. A large range of our products are still either self-produced or manufactured in German and European companies, which guarantees us a fast and efficient access to product and quality control. If nothing less, the quality standard of LINDNER is convincing worldwide in function, workmanship and design.

## THE SERVICE...

Our high-quality standards of control extend themselves into our after sales service and our experienced advisory service. This applies equally for our advisory teams in our headquarter in Schömburg, as well as for our representatives worldwide. Through a long established collaboration with our sales partners we are now represented in 100 countries of the world.



Visit us on Facebook!

[www.facebook.com/lindnerfalzlos/](http://www.facebook.com/lindnerfalzlos/)



Visit us on Instagram!

[www.instagram.com/lindner.falzlos/](http://www.instagram.com/lindner.falzlos/)

## LINDNER Falzlos-Gesellschaft mbH

Rottweiler Straße 38  
D-72355 Schömburg

Telefon +49 (0) 74 27 / 70 10  
Telefax +49 (0) 74 27 / 61 18

[export@lindner-original.de](mailto:export@lindner-original.de)  
[www.lindner-original.de](http://www.lindner-original.de)

All prices and specifications are subject to change without prior notice. All products are offered without stamps, coins, or any other contents.

# INDEX

Everything for the collector!

<b>A</b>		<b>G</b>		<b>R</b>	
Accessories for custom page design.....	67	Glassine envelopes .....	91	Rectangular coin capsules.....	13
Advantage offers.....	60, 67, 113	Gloves .....	47	Ring binder 18-Rings .....	72-74
ALU Showcase.....	102	Guillotine mount cutters.....	67, 69	Ring binder "Exclusive" .....	73
Aluminum Cases.....	18-23	Guillotine .....	69	Ring binder "Leather" .....	73
Approval cards and box.....	87			Ring binder for LINDNER formats .....	72-75
Authentic wood box .....	17	<b>H</b>		Ring binder Half penny .....	42
		Half Penny .....	42	Ring binder Multi Collect.....	80
<b>B</b>		HARTBERGER® Accessories .....	14-15	Ring binder PUBLICA.....	43, 55, 81, 84, 95-97
Banknote Album and pages.....	51-56, 75, 81, 96			Ring binder REGULAR .....	72
Billets Souvenirs 0-Euro.....	51, 56	<b>I</b>		Ring binder RONDO REGULAR .....	42, 80, 83
Blank pages.....	40, 65, 78, 97	Illustrated album pages and supplements dT.....	124, 128	Ring binder SRS.....	75
Box for watches NERA Varius .....	103	Illustrated album pages and supplements T.....	113-128	Ring binder STANDARD .....	72
		Illustrated albums for stamps .....	113-128		
<b>C</b>		Indicator decals .....	67	<b>S</b>	
Caliper.....	47	Inserts for write-ups .....	64	Scales.....	47
CARRÉE Coin capsules.....	16	Inserts .....	11	Schildfix.....	9
CARUS .....	28-29, 31, 48			Slabs .....	18, 23
Cases .....	18-23	<b>J</b>		Slipcase for stockbooks .....	76
Champagne lids Collection Systems .....	104	Jetons Touristiques.....	105	Slipcase pull-handle .....	73
Cleaner.....	46			Slipcase ring binder ECO.....	74
Cleaning machine for coins .....	47	<b>K</b>		Souvenir notes 0-Euro.....	51
Cleaning products.....	46	karat series.....	32-39, 51, 105	SRS series .....	52, 75
Coin album PUBLICA M and S .....	33, 43, 95			Stackable collection boxes .....	101
Coin albums.....	32-39, 42-46, 95-96	<b>L</b>		Stamp album with screw mechanism.....	77
Coin box BLACK SAMT.....	7, 9	Labeling cards .....	49	Stamp care, ERNI.....	57, 88
Coin box capsules.....	11	Leather ring binder.....	33, 73	Stamp hingers.....	67
Coin box carrying case.....	22	LED Light Pad .....	109	Stamp remover .....	88
Coin box display.....	9	Linentester.....	111-112	Stamp tongs .....	47, 90
Coin box inserts.....	11	Little coin cases.....	24, 48-50	Stampscop .....	90
Coin boxes.....	4-9			Stockbook pages "OMNIA" .....	70
Coin capsule set for one EURO coin set .....	12	<b>M</b>		Stockbooks for stamps.....	76
Coin capsules CARRÉE.....	16	Magnifiers, ESCHENBACH.....	112	Stockpages.....	77, 97
Coin capsules .....	11-13, 16	Magnifiers.....	108, 110-112	Supplementary assortment for coin boxes.....	9
Coin care products.....	46-47	Microscopes .....	109		
Coin cases CARUS.....	28-29, 31, 48	Mint sheet albums .....	89	<b>T</b>	
Coin cases NERA .....	24-27, 103	Mint sheet page.....	70	T-Blank-System .....	58-63
Coin cases.....	24-31, 48	Mounts kiloware.....	69	T-System introduction .....	58
Coin cleaner .....	46	Mounts program .....	68-69	Test lamps .....	108-109
Coin cleaning machine.....	47	Multi BIG banknote album .....	53	Trading Cards series.....	98
Coin envelopes .....	49	Multi collect for banknotes .....	54	Trays for Coin carrying case .....	20
Coin gloves.....	47	Multi collect for coins.....	41-43	Trays.....	88
Coin holders .....	14	Multi collect system .....	40-41		
Coin pages.....	32, 41	Multifunctional tester .....	109	<b>U</b>	
Coin scales.....	47	Médailles Souvenirs .....	105	Ultrasonic cleaner.....	47
Coin suitcase .....	20-23			UNIPLATE System .....	86
Coin tong.....	47	<b>N</b>		Universal album FIRMO .....	56, 82
Coin trays.....	20	NERA.....	24-27, 31, 103	UV Test lamps.....	108
Coincards collecting album .....	45	NIMBUS.....	16, 106-107	UV-Flashlight .....	108
Coins Illustrated albums.....	34-39, 44-46				
Collection box for pins/medals/emblems .....	101	<b>O</b>		<b>V</b>	
Collection boxes .....	10, 99-101	OMNIA Stockbook pages .....	70	Vibration cleaner.....	47
Collection case Multi.....	19	Optical accessories.....	108-112		
Collection/presentation boxes for swiss pocket knives .....	99			<b>W</b>	
Country labels.....	32	<b>P</b>		Wood box for coin holders/Carrée .....	17
Crystal clear pocket pages .....	64, 71	Page lifters.....	73	Wood cases CARUS for coins .....	28-29, 31, 48
		Paper bags.....	49		
<b>D</b>		Perforation gauge.....	90	<b>Z</b>	
d-Boxes.....	10	Pergamin sleeves .....	91	Zip-bags.....	94
DigiMicroscope.....	109	Phila-Combi-Box.....	90		
Digital caliper.....	47	Photo corners .....	67		
Drying books.....	89	PINS.....	25, 101		
dT-Blank-pages.....	64	Pocket album for banknotes .....	56		
		Pocket album for coin holders .....	15		
<b>E</b>		Pocket coin album.....	49		
ECO Slipcase ring binder.....	74	Polybag.....	94		
ERNI, Stamp care.....	57, 88	Postcard albums and pages.....	75, 84-85, 96		
ESCHENBACH.....	112	Presentation box made of synthetic material.....	101-102		
Euro coin albums and accessories.....	34-39, 44-46	Presentation case ALU .....	30		
Euro pocket books .....	49	Pressed Pennies.....	14, 39		
Exhibition protectors .....	64	Price labels.....	89		
EXPO system Plexiglass.....	102	Protective covers with self-adhesive strip.....	57, 93		
		Protective covers/sleeves .....	57, 92-93		
<b>F</b>		Protective foil page.....	70		
FDC albums and pages .....	83	PUBLICA.....	33, 43-46, 51, 54-55, 81, 84, 95-97		
FIRMO Universal albums .....	56, 82				
First day sheet albums and pages.....	56, 82-83				
Flag-pages .....	32				
Flags.....	89				
freestyle foil sheets/protective sleeves .....	57, 66, 93				

# LINDNER

*Das Original*



MADE IN GERMANY

## LINDNER COIN BOXES

- representative, crystal clear, distortion-free
- stackable, non-skid base
- fits into a wide range of coin cases
- resistant velour insert available in two different shades of red, marine blue and black
- handy size: width 236 mm, depth 303 mm, height 20 mm (Coin Box), 30 mm (d-Box) and 40 mm (Collection Box)
- dimensions suitable for safes
- suitable to fit in most shelves and cabinets
- precise engineering of the synthetic frames enables a smooth sliding of the drawer

# LINDNER COIN BOXES



The LINDNER coin boxes are easy to handle and the large selection provides flexibility for every coin collector. Coin collectors who already use the coin box system know that years of experience helped develop and improve this exceptional product line to satisfy the wishes of every coin collector and to provide individual storage solutions. Years ago, LINDNER developed the perfect coin box system with the help of coin specialists and coin collectors. **To ensure that you have purchased an original, high-quality LINDNER coin box, look for the "LINDNER" logo on the top of the tray pull handle.**

LINDNER coin boxes offer many possibilities and varieties for storage. **The unique stacking**

**system allows you to select from 3 different heights of the boxes and from over 150 different configurations to hold small, large, thick and thin coins;** as well as capsules and coin holders. Choose from different carrying cases to protect your coin or collection boxes.

The LINDNER coin box system can be expanded without limits. The boxes are stackable, sturdy, fit into most safes and match almost any decor. LINDNER offers a variety of practical accessories which – in combination with the coin boxes – provide a successful and safe storage solution for all your coins, medals and banknotes. All materials used in the manufacturing process of the LINDNER coin boxes have been subjected to

rigorous tests. The synthetic frame is scratch-resistant to ensure long-term usage and to maintain attractive appearance. LINDNER coin boxes are practical, versatile, safe and attractive!

### The "Original"

"Original" only with LINDNER logo on tray pull handle.



## STYLES

### Standard

Grey drawer with light red velour insert and crystal clear frame.



### Smoked glass

"Smoked glass" drawer with winered velour insert and crystal clear frame.



### Marine

Grey drawer with dark blue velour inserts and crystal clear frame.



### Carbo

Grey drawer with black velour inserts and crystal clear frame.



The red, winered, dark blue and black velour inserts create an ideal contrast to silver and gold coins, as well as medals. The crystal clear synthetic frame offers a clear view on your treasures. The high-quality velour inserts of our coin boxes are also available separately. This offers the possibility of "re-equipping" coin boxes or integrating the velour inserts into your own individual system. Format of the coin box inserts: 225 x 285 mm.

## SIZES

### Coin Box Height 20 mm

Width 236 mm, Depth 303 mm  
(Page 4-9)



### d-Box Height 30 mm

Width 236 mm, Depth 303 mm  
(Page 10)



### Collection Box Height 40 mm

Width 236 mm, Depth 303 mm  
(Page 10, 100-101)



COIN BOXES WITH ROUND COMPARTMENTS FOR SINGLE COINS AND COIN SETS

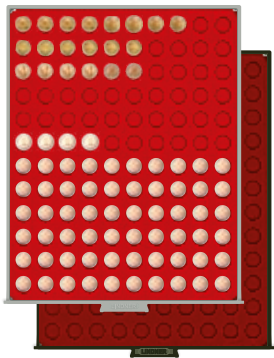

Ø 16.5 mm 120x  
 ● 2501 ● 2901  
 1 €-Cent, 1 Pfennig, 1 Rappen, 1/10 Oz American Eagle / Britannia / Kangaroo / Krugerrand / Libertad / Maple Leaf / Vienna Philharmonic (gold), 1/10 Oz Britannia / Libertad (silver)

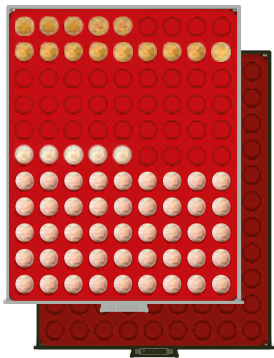

Ø 19.25 mm 99x  
 ● 2502 ● 2902  
 2 €-Cent, 2 Pfennig, 5 Marks Kaiserreich (gold), 20 € "Deutscher Wald" (gold), 10 Crowns Austria (gold), 10 Rappen, 10 Vreneli CHF (gold), 1/10 Oz Lunar II / Panda (gold)

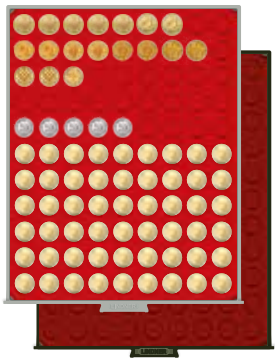

Ø 20.0 mm 99x  
 ● 2550 ● 2950  
 10 €-Cent, 50 Pfennig, 10 Marks Kaiserreich (gold), 1/4 Oz "Luther Rose" 50 € (gold), 2 Rappen, 1/4 Oz Maple Leaf (gold), 1/10 Oz Libertad (silver)

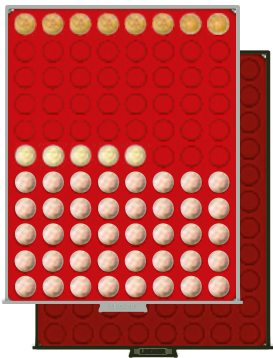

Ø 21.5 mm 88x  
 ● 2510 ● 2910  
 5 €-Cent, 10 Pfennig, 20 Rappen, 20 Vreneli CHF (gold), 1/4 Oz Kangaroo (gold), 1/10 Oz Koala (silver)

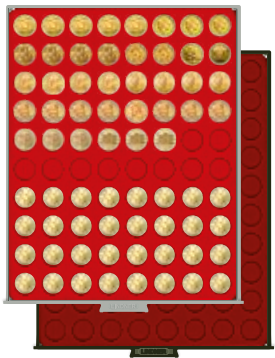

Ø 22.25 mm 80x  
 ● 2580 ● 2980  
 20 €-Cent, 1 Pound Great Britain (gold), 1/4 Oz France (gold), 1/4 Oz American Eagle / Britannia / Panda / Krugerrand / Queen's Beasts / Vienna Philharmonic (gold), 1/4 Oz Britannia (silver)

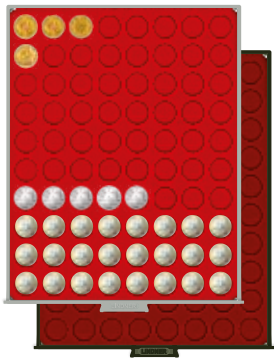

Ø 23.5 mm 80x  
 ● 2108 ● 2708  
 1 €, 1 DM, 1 DM (gold), 20 Marks Kaiserreich (gold), 5 Austrian shillings, 1 CHF, 1 Franc (silver), 1/4 Oz Libertad / Lunar II (gold)

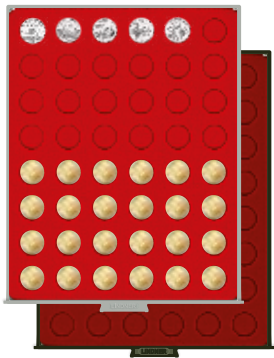

Ø 24.25 mm 48x  
 ● 2549 ● 2949  
 50 €-Cent, 1 Marks Kaiserreich (silver), 25 Cent (USA, State Quarters)

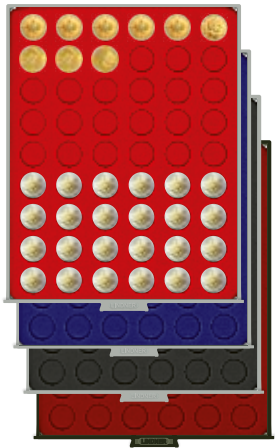

Ø 25.75 mm 54x  
 ● 2154 ● 2154M  
 ● 2754 ● 2154C  
 2 €, 10 Francs from 1974, 1/2 Oz Maple Leaf / Kangaroo (gold)

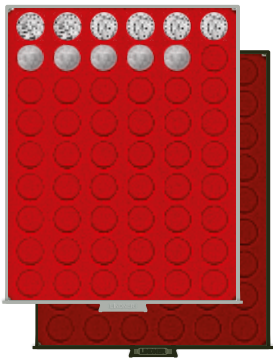

Ø 26.75 mm 54x  
 ● 2109 ● 2709  
 2 DM, 2 Reichsmark (Ag/Cu), 50 Kopeek Nicholas II, 1895-1914 (silver)

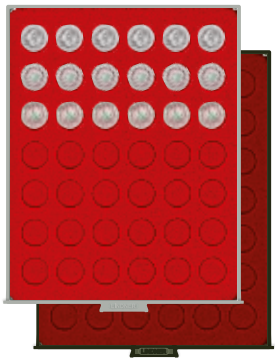

Ø 27.5 mm 42x  
 ● 2107 ● 2707  
 5 € Germany, 50 Austrian shillings (Bi-Metall), 2 CHF, 1/2 Oz American Eagle / Britannia / Krugerrand / Panda (gold), 1/4 Oz Libertad (silver), 1/2 Oz Britannia (silver)

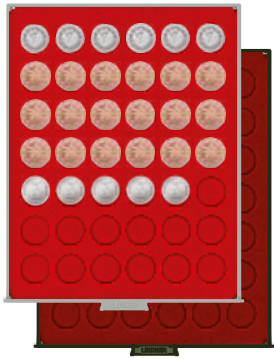

Ø 29.5 mm 42x  
 ● 2105 ● 2705  
 10 € Polymer Germany, 100 € Germany (gold), 5 DM, 2 Marks Kaiserreich (silver), 5 € Austria (silver), 50 Francs (gold), 5 Francs from 1960 (silver), 1/2 Oz Libertad / Vienna Philharmonic (gold)



Ø 31.0 mm 35x  
 ● 2104 ● 2704  
 25 €/50 € "Tellermünze" Germany, 3 Reichsmark (Ag/Cu), 10 DM (DDR), 25 Austrian shillings, 5 CHF, 100 Francs (silver), 1/2 Oz France (gold), 1/2 Oz Lunar II (gold), 1 Oz Maple Leaf (gold)

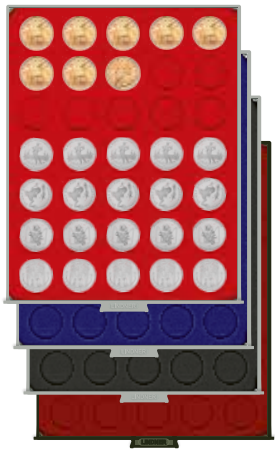

Ø 32.5 mm 35x  
 ● 2111 ● 2111M  
 ● 2711 ● 2111C  
 10 €/20 €/35 € Silver Germany, 1 Oz 200 € Germany (gold), 10 DM, 1 Oz American Buffalo / American Eagle / Britannia / Kangaroo / Krugerrand / Panda / Queen's Beasts (gold)



Ø 32.5 mm 24x  
 ● 2110  
 10 €/20 €/35 € Silver Germany, 1 Oz 200 € Germany (gold), 10 DM, 1 Oz American Buffalo / American Eagle / Britannia / Kangaroo / Krugerrand / Niue Turtle / Panda / Queen's Beasts (gold)



Ø 34 mm 30x  
 ● 2150 ● 2750  
 Médailles Souvenirs, 3 Marks Kaiserreich (silver), 20 € France (silver), 20 CHF, 3 € Tiertaler Austria, 100 Austrian shillings (gold), 5 Roubels Olympia (silver), 1/2 Oz Libertad / Maple Leaf / Panda (silver)

LINDNER coin boxes, d-boxes and collection boxes can be mixed and stacked on top of each other. Only the height of each box is different!

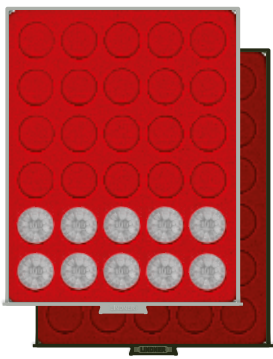

Ø 36.0 mm 30x

● 2101 ● 2701

5 Reichsmark (Ag/Cu),  
100 Austrian shillings,  
1/2 Oz Koala / Lunar II (silver)



Ø 37.0 mm 30x

● 2161\*

10 € France (silver),  
5 Francs until 1889 (silver),  
1 Oz Vienna Philharmonic (gold),  
1/2 Oz Koala (silver),  
1 Oz Vienna Philharmonic (silver)

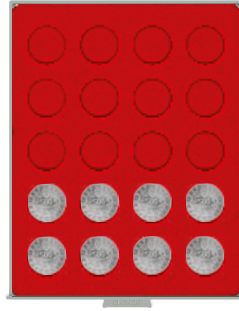

Ø 38.0 mm 20x

● 2102

5 Marks Kaiserreich (silver),  
500 Austrian shillings, 1 Oz Maple  
Leaf / Canadian Wildlife (silver)

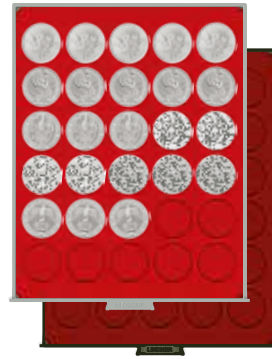

Ø 39.0 mm 30x

● 2106 ● 2706

3 Roubels commemorative coin  
(silver), 10 Roubels Olympia (silver),  
1 Oz Lunar II (gold), 1 Oz Krugerrand  
/ Maple Leaf (silver), 2 Oz Queen's  
Beasts (silver)

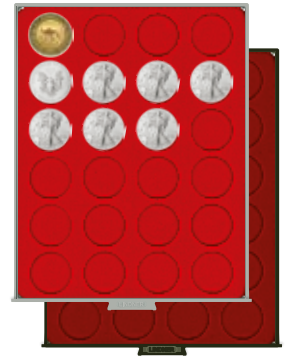

Ø 41.0 mm 24x

● 2160 ● 2760

50 € France (silver), 2 Oz Kangaroo  
/ Lunar II (gold), 1 Oz American  
Eagle / Britannia / Niue Turtle /  
Kangaroo / Koala / Kokkabarra /  
Libertad (silver), 2 Oz Niue Turtle  
(silver)

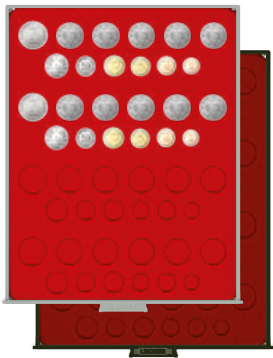

48 Compartments

● 2204 ● 2604

4x German Mark Coin set

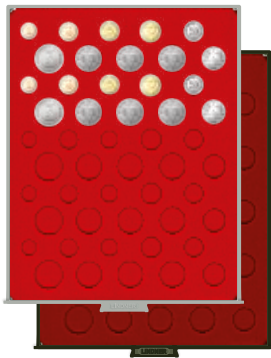

50 Compartments

● 2207 ● 2607

5x German Mark Coin set

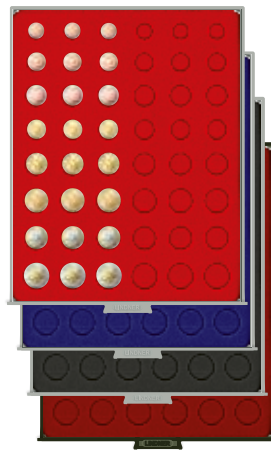

48 Compartments

● 2506 ● 2506M

● 2906 ● 2506C  
6x €-Coin set

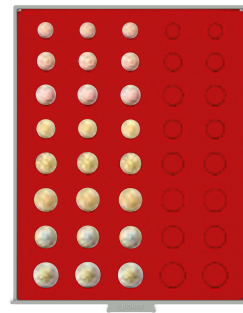

40 Compartments

● 2555

5x €-Coin set

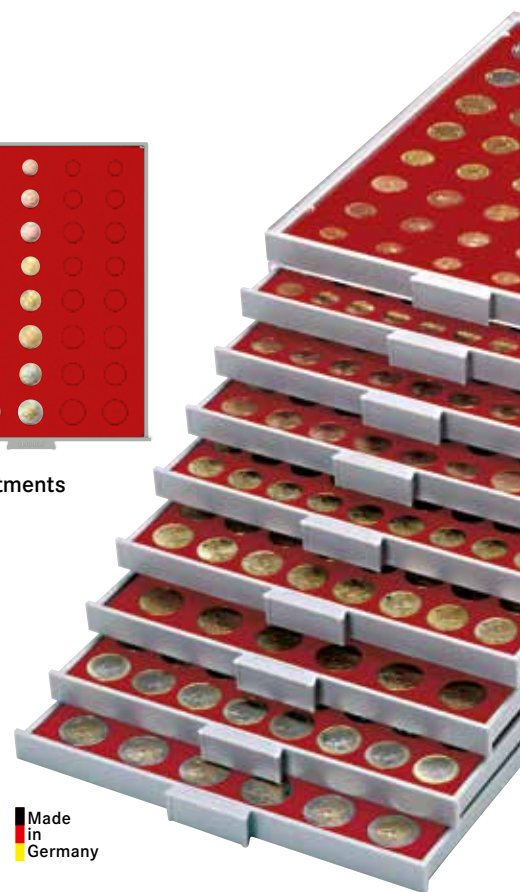

**LINDNER - Coin box recess:**  
Simply press on the back half of  
the coin and it will lift at the front;  
then remove it with ease.

**Format:**  
236 x 303 x 20 mm

COIN BOX

€ 25.50

Made  
in  
Germany

**COIN BOXES FOR EURO COINS**



- |        |        |        |         |         |         |        |         |        |                         |                   |  |
|--------|--------|--------|---------|---------|---------|--------|---------|--------|-------------------------|-------------------|--|
| 1 Cent | 2 Cent | 5 Cent | 10 Cent | 20 Cent | 50 Cent | 1 Euro | 2 Euro  | 5 Euro | 10 Euro<br>polymer ring | 10/20/<br>35 Euro | ● 2506<br>● 2906<br>● 2506M<br>● 2506C |
| ● 2501 | ● 2502 | ● 2510 | ● 2550  | ● 2580  | ● 2549  | ● 2108 | ● 2154  | ● 2107 | ● 2105                  | ● 2111            |  |
| ● 2901 | ● 2902 | ● 2910 | ● 2950  | ● 2980  | ● 2949  | ● 2708 | ● 2754  | ● 2707 | ● 2705                  | ● 2711            |  |
|        |        |        |         |         |         |        | ● 2154M |        |                         | ● 2111M           |  |
|        |        |        |         |         |         |        | ● 2154C |        |                         | ● 2111C           |  |

LINDNER coin boxes, d-boxes and collection boxes can be mixed and stacked on top of each other. Only the height of each box is different!

**COIN BOXES WITH ROUND COMPARTMENTS FOR SINGLE COINS AND COIN SETS IN COIN CAPSULES**

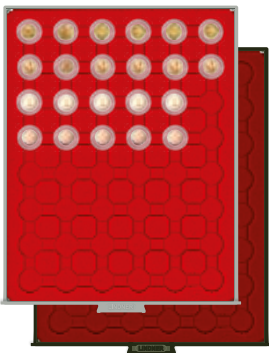

Ø 24.0 mm 48x

● 2524 ● 2924

☉ 2250018P

1 €-Cent, 1/10 Oz Libertad / Maple Leaf / Vienna Philharmonic (gold), 1/10 Oz Libertad (silver), 1/10 Oz American Eagle / Britannia / Kangaroo / Krugerrand (gold), 1/10 Oz Britannia (silver), 20 € "Deutscher Wald" (gold), 5 Marks Kaiserreich (gold), 5 Rappen

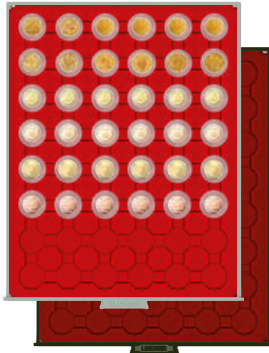

Ø 26.0 mm 48x

● 2548 ● 2948

☉ 2250020P

10 €-Cent, 2 Pfennig, 10 Marks Kaiserreich (gold), 10 Crowns Austria (gold), 10 Rappen, 10 Vreneli CHF (gold)



Ø 29.5 mm 42x

● 2529 ● 2929

☉ 2250023P

20 Marks Kaiserreich (gold), 1/4 Oz Lunar II (gold), 1 Franc (silver)

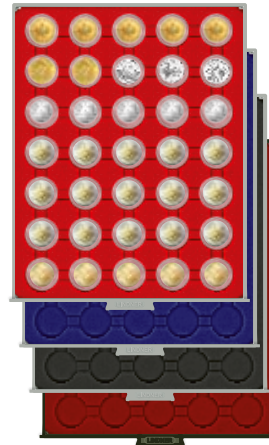

Ø 32.0 mm 35x

● 2530 ● 2530M ● 2930 ● 2530C

☉ 2250026P

2 €, 10 Francs ab 1974, 1/2 Oz Kangaroo / Maple Leaf (gold), 1/4 Oz Panda (silver)



Ø 34.0 mm 35x

● 2535 ● 2935

☉ 2250275P

5 € Germany, 1/2 Oz American Eagle / Britannia / Krugerrand / Panda (gold), 1/4 Oz Libertad (silver), 1/2 Oz Britannia (silver), 50 Austrian shillings, 1996-2001 (Bi-metal), 20 Austrian shillings, 2 CHF, 50 Francs (gold)

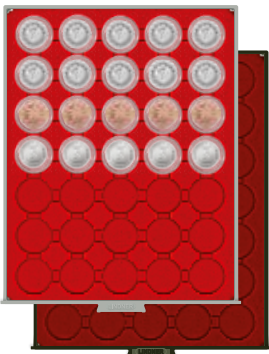

Ø 36.0 mm 35x

● 2225 ● 2625

☉ 2250029P

☉ 2250295P

☉ 2250030P

10 € Polymer Germany, 100 € commemorative coin Germany (gold), 2 Marks Kaiserreich (silver), 5 Francs from 1960 (silver), 1/2 Oz Vienna Philharmonic (gold), 2 Austrian shillings, 5 € Austria, 5 DM, 5 Marks/DDR (Cu/Ni), 1/2 Oz Libertad (gold)

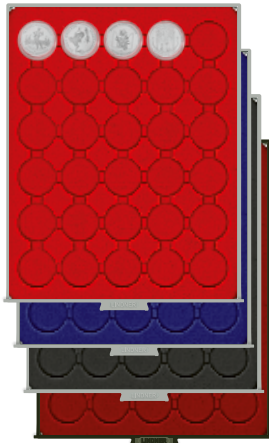

Ø 37.5 mm 30x

● 2537 ● 2537M ● 2937 ● 2537C

☉ 2260325P

10 €/20 €/35 € Silver Germany (Special Capsule: Same as the original capsule 10 €/20 €/35 € proof silver coins Germany)



Ø 39.5 mm 30x

● 2226 ● 2226M ● 2626 ● 2226C

☉ 2250325P

☉ 2250033P

10 €/20 €/35 € Silver Germany, 10 DM, 200 € gold coin, 1 Oz Niue Turtle (gold), 1 Oz American Buffalo / American Eagle / Britannia / Kangaroo / Krugerrand / Queen's Beasts (gold)

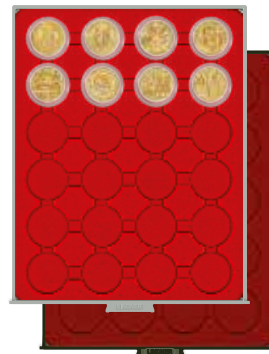

Ø 41.0 mm 24x

● 2224 ● 2624

☉ 2250345P

☉ 2250035P

20 US \$ Liberty (gold), 20 Francs (1929-1939), 100 Francs (gold), 1 Oz Libertad (gold), Médailles Souvenirs, 3 € "Tiertaler" Austria, 1/2 Oz Maple Leaf / Panda (silver)

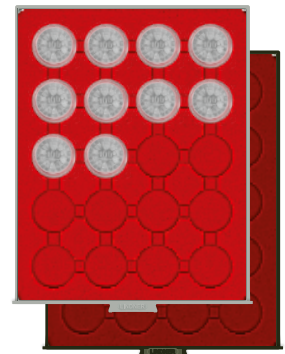

Ø 42.0 mm 20x

● 2103 ● 2703

☉ 2250036P

100 Austrian shillings (silver)

**COIN BOXES FOR EURO COINS IN COIN CAPSULES**



2 Euro

☉ 2250026P

● 2530

● 2930

● 2530M

● 2530C



5 Euro

☉ 2250275P

● 2535

● 2935



10 Euro polymer ring

☉ 2250029P

● 2225

● 2625



10/20/35 Euro

(without edge/PP) ☉ 2260325P

● 2537

● 2937

● 2537M

● 2537C



10/20/35 Euro

☉ 2250325P

● 2226

● 2626

● 2226M

● 2226C



5 Euro

☉ 2250295P

● 2225

● 2625



3 Euro Tiertaler

☉ 2250345P

● 2224

● 2624



10 Euro

☉ 2250315P

● 2537

● 2937

● 2537M

● 2537C



10 Euro

☉ 2250E

● 2556

● 2956

● 2556M

● 2556C

LINDNER coin boxes, d-boxes and collection boxes can be mixed and stacked on top of each other. Only the height of each box is different!



Ø 44.0 mm 20x

● 2544 ● 2944

☉ 2250038P

1 Oz Vienna Philharmonic (gold),  
1 Oz Vienna Philharmonic (silver)

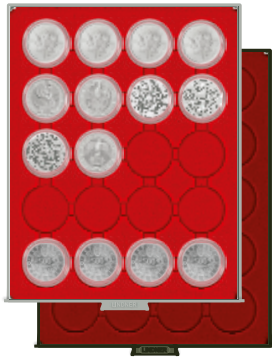

Ø 46.0 mm 20x

● 2220 ● 2620

☉ 2230P

☉ 2630P

☉ 2250039P

☉ 2250040P

☉ S2255384P

1 Oz Krugerrand (silver),  
1 Oz BIG FIVE, South Africa (silver),  
1 Oz Lunar II (gold), 10 Roubels  
Olympia (silver) 1 1/2 Oz Canadian  
Wildlife Polarbear / Polarfox (silver),  
1 1/4 Oz Canadian Wildlife Bison  
(silver)



Ø 48.0 mm 20x

● 2520 ● 2920

☉ 2250041P

☉ 2250042P

1 Silver Dollar, 2 Oz Kangaroo (gold),  
1 Oz American Eagle / Kangaroo /  
Koala / Kookaburra / Panda (silver),  
50 € France (silver), 2 Oz Lunar II  
(gold)

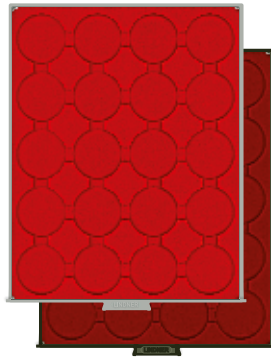

Ø 49.0 mm 20x

● 2543 ● 2943

☉ 2250043P

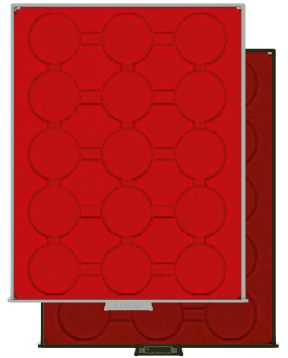

Ø 51.0 mm 15x

● 2515 ● 2915

☉ 2250045P

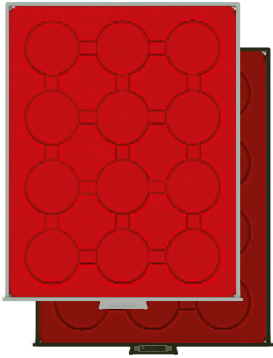

Ø 54.0 mm 12x

● 2554 ● 2954

☉ 2250048P

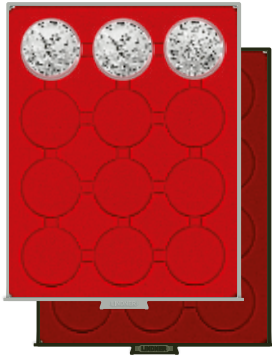

Ø 58.0 mm 12x

● 2212 ● 2612

☉ 2231P

☉ 2631P

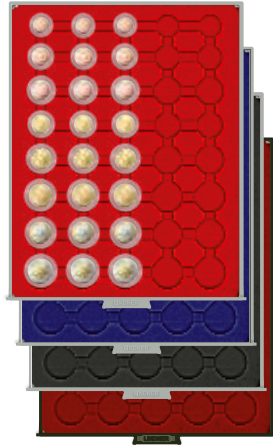

40 Compartments

● 2556 ● 2556M

● 2956 ● 2556C

☉ 2250E

5x €-Coin set



**COIN BOX  
BLACK SAMT**

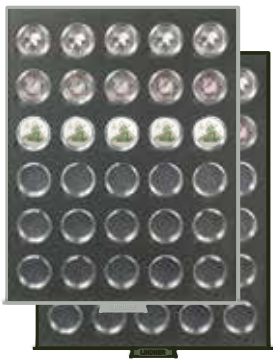

Ø 34.0 mm 30x

● S2533-2K

● S2933-2K

Incl. 30 coin capsules  
€ 41.50



**Format:  
236 x 303 x 20 mm**

COIN BOX

€ 25.50

Made  
in  
Germany

Coin capsules  
see page 12-13.



Coin box carrying cases  
see page 22.

LINDNER coin boxes, d-boxes and collection boxes can be mixed and stacked on top of each other. Only the height of each box is different!

COIN BOXES WITH SQUARE COMPARTMENTS

<p><b>19.0 mm</b> 99x</p> <p>● 2199 ● 2799</p> <p>2 €-Cent, 5 Pfennig, 10 Rappen, 10 Crowns Austria (gold), 10 Vreneli SFR (gold), 1/10 Oz Lunar II (gold)</p>	<p><b>24.0 mm</b> 80x</p> <p>● 2180 ● 2180M</p> <p>● 2780 ● 2180C</p> <p>1 DM, 1 DM (gold), 1 Marks Kaiserreich (silver), 5 Austrian schillings</p>	<p><b>28.0 mm</b> 48x</p> <p>● 2149 ● 2749</p> <p>5 € Germany, 100 € commemorative coin Germany (gold), 2 Marks Kaiserreich (silver), 20 Austrian schillings, 50 Francs (gold), 1/2 Oz Vienna Philharmonic (gold)</p>	<p><b>30.0 mm</b> 48x</p> <p>● 2148 ● 2148M</p> <p>● 2748 ● 2148C</p> <p>10 € Polymer Germany, 5 DM, 5 € Austria (silver), 1/2 Oz Libertad (gold), 1 Oz Maple Leaf (gold)</p>	<p><b>30.0 mm</b> 48x</p> <p>● 2148F ● 2748F</p> <p>Campagne lids (Compartments less deep)</p>
<p><b>36.0 mm</b> 35x</p> <p>● 2135 ● 2135M</p> <p>● 2735 ● 2135C</p> <p>Médailles Souvenirs, 5 Reichsmark (Ag/Cu), 100 Austrian schillings (gold), 100 Vreneli SFR (gold), 100 Francs (gold), 1/2 Oz Lunar II / Maple Leaf / Panda (silver)</p>	<p><b>38.0 mm</b> 30x</p> <p>● 2115 ● 2115M</p> <p>● 2715 ● 2115C</p> <p>5 Marks Kaiserreich (silver), 500 Austrian schillings, 10 € France (silver), 1 Oz Canadian Wildlife / Maple Leaf / Vienna Philharmonic (silver), 1 Oz Vienna Philharmonic (gold)</p>	<p><b>42.0 mm</b> 24x</p> <p>● 2124 ● 2124M</p> <p>● 2724 ● 2124C</p> <p>50 € France (silver), 2 Oz Lunar II (gold), 1 Oz American Eagle / Kangaroo / Koala / Kokkburra (silver), 2 Oz Niue Turtle (silver)</p>	<p><b>47.0 mm</b> 20x</p> <p>● 2120 ● 2120M</p> <p>● 2720 ● 2120C</p> <p>100 € France (silver), 1 Oz Lunar II (silver)</p>	<p><b>50.0 mm</b> 20x</p> <p>● 2122 ● 2122M</p> <p>● 2722 ● 2122C</p> <p>CARRÉE, Coin holders 50 x 50 mm, 5 Oz France (silver), 2 Oz Libertad (silver)</p>
<p><b>51.0 mm</b> 20x</p> <p>● 2221 ● 2621</p> <p>Coin box inserts, 2 Oz Kokkburra (silver) in original capsules, 5 Oz France (silver), 2 Oz Libertad (silver)</p>	<p><b>51.0 mm</b> 20x</p> <p>● 2121 ● 2721</p> <p>Compartments a little deeper, e.g. suitable for all common silver coins 1 and 2 ounces (Oz), also in Coin capsules</p>	<p><b>66.0 mm</b> 12x</p> <p>● 2112 ● 2712</p> <p>5 Oz Panda (gold), 2 Oz Kokkburra / Lunar II (silver), 5 Oz Niue Turtle (silver)</p>	<p><b>68.0 mm</b> 12x</p> <p>● 2213 ● 2613</p> <p>Encapsulated coins, Coin box inserts, Coin holders 67 x 67 mm</p>	<p><b>24 mm, 28 mm, 39 mm, 44 mm / 45 compartments</b></p> <p>● 2145 ● 2145M</p> <p>● 2745 ● 2145C</p>

LINDNER coin boxes, d-boxes and collection boxes can be mixed and stacked on top of each other. Only the height of each box is different!

## COIN BOXES WITH RECTANGULAR COMPARTMENTS

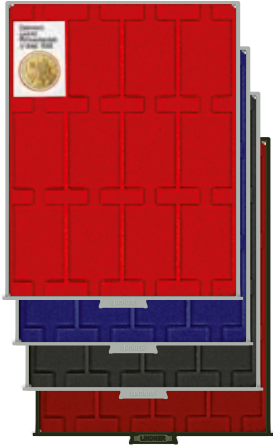

50 x 75 mm / 12x

● 2170 ● 2170M  
● 2770 ● 2170C

REBECK COIN L Coin holders



63 x 85 mm / 9x

● 2219 ● 2219M  
● 2619

Slabs (original US coin capsules),  
coincards



150 x 150 mm

● 2211 ● 2611

Originally sealed 10 DM  
commemorative coins (PP)  
with all 5 mint initials

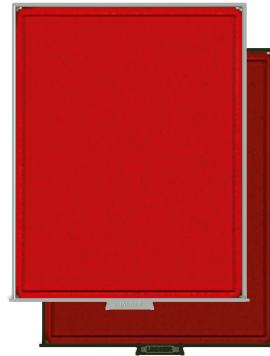

210 x 270 mm

● 2100 ● 2700

One large compartment



## COIN BOX BLACK SAMT



27 x 47 mm / 20x

● S2533-4 ● S2933-4

without coin capsules  
€ 34.50



27 x 47 mm / 20x

● S2533-4K ● S2933-4K

incl. 20 coin capsules  
€ 41.50

 Suitable rectangular coin capsules (S2252747P)  
see page 13.

Format:  
236 x 303 x 20 mm

COIN BOX

€ 25.50

 Made  
in  
Germany



## ACCESSORY KIT

Contains 4 non-skid snap-on buttons for the bottom of a coin box or collection box and 1x LINDNER Schildfix.

€ 2185

€ 14.50

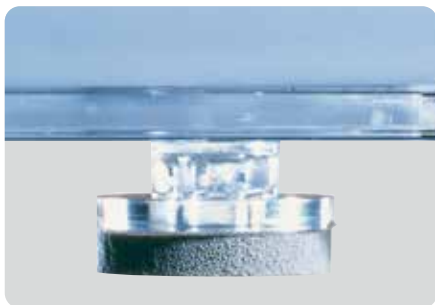

## LINDNER SCHILDFIX

LINDNER Schildfix for an easy and individual labelling of coin boxes, d-boxes and collection boxes. Content: 5 self-adhesive transparent strips, length 90 mm and 10 white pre-cut labels for inserting descriptions.

€ 2188

€ 6.50



## COIN BOX DISPLAY

Coin box display, made of metal, colour: white.

€ 2189

€ 8.00



LINDNER coin boxes, d-boxes and collection boxes can be mixed and stacked on top of each other. Only the height of each box is different!

# D-BOXES

## HEIGHT 30 mm – SPACE FOR THE "LARGE" AND THE "THICK"

The LINDNER d-box offers more options for the coin and medal collector. The drawer has a height of 22 mm to store and protect especially large and thick coins. LINDNER coin boxes, d-boxes and collection boxes can be mixed and stacked on top of each other. Only the height of each box is different!

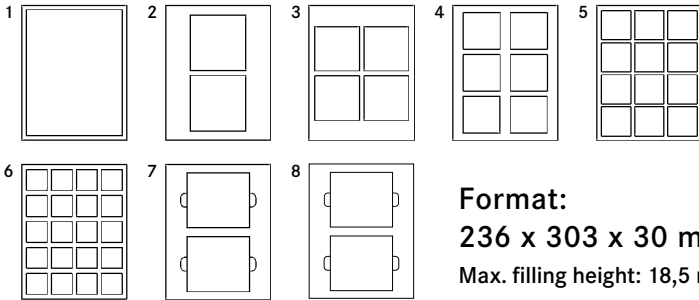

**Format:**  
236 x 303 x 30 mm  
Max. filling height: 18,5 mm

Made in Germany

DOUBLE BOXES

€ 42.00



No.	Quantity of compartments	Standard		Smoked glass		SUITABLE FOR:
		24	24	24	24	
1	1	210 x 270 mm	2800	2850	Medals, extra large or thick coins. The d-boxes 2, 3 and 4 are also ideal for the €-starter-kits (see ill.)	
2	2	125 x 125 mm	2802	2852		
3	4	100 x 100 mm	2804	---		
4	6	85 x 85 mm	2806	2856		
5	12	66 x 66 mm	2812	2862		
6	20	47 x 47 mm	2820	2870		
7	2	140 x 123 mm	2805	2855	2x 5 original, uncirculated € coin sets 2002-2014, Germany	
8	2	152 x 123 mm	2803	---	20 € Silver coins in original presentation folder, original, uncirculated € coin sets Germany 2015 and up: 2x 5 in mint state or 2x 2 in proof-like quality	



# COLLECTION BOX

## HEIGHT 40 mm – EXTRA ROOM FOR COLLECTORS SPECIAL WISHES!

### 1 Collection Box »Eplalux«

Two rectangular compartments hold a maximum of 24 mint sets of coins issued by the German Federal Bank.

Size: 170 x 107 mm.

☞ 2408 Standard

☞ 2468 Smoked glass

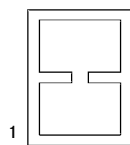

### 2 Collection Box »Eplalux«

Holds up to 12 "Eplalux" cases (proof sets of the German Federal Bank) in three rectangular compartments.

Size: 160 x 100 mm.

☞ 2407 Standard

☞ 2467 Smoked glass

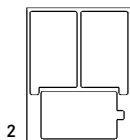

LINDNER coin boxes, d-boxes and collection boxes can be mixed and stacked on top of each other. Only the height of each box is different!



**Format:**  
236 x 303 x 40 mm  
Max. filling height: 29 mm



Made in Germany

COLLECTION BOX

€ 46.50

An extensive description of the LINDNER collection box system and all its possibilities are found on pages 100-101. Fitting cases on page 22.

# COIN BOX CAPSULES FOR COINS Ø 16 - 51 mm

More safety and flexibility with coin box capsules: Additional protection for all your coins against environmental influences, fingerprints, dirt, skin oil and moisture! Two capsule sizes offer maximum flexibility by holding coins from Ø 16 up to 51 mm. Every capsule contains a red insert consisting of several concentric rings. The number

of rings of the inserts can be adjusted to accommodate the coin. Multiple coin sizes can be kept in one coin box. The capsules come in red or winered, matching the velour insert of our "Standard" or "Smoked glass" coin boxes.

**Material rings:** PP polypropylene



				MATCHING COIN BOX:		Quantity of compartments	
1	2230P	Coin box capsules, small External Ø 46 mm	Ø 16 - 39 mm	€ 16.00	2220	2620	20
	2630P				2212	2612	
2	2231P	Coin box capsules, large External Ø 58 mm	Ø 16 - 51 mm	€ 16.00	2212	2612	12
	2631P						

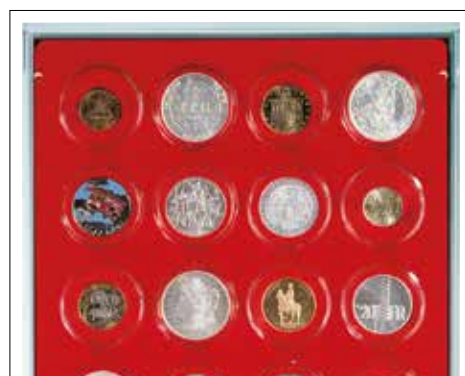
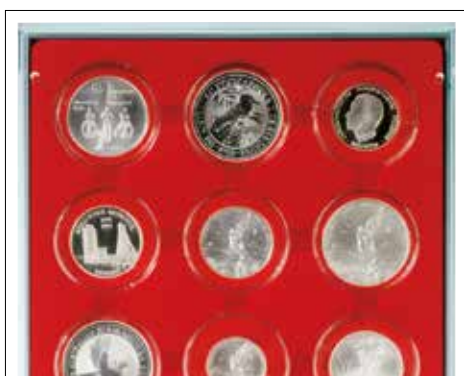
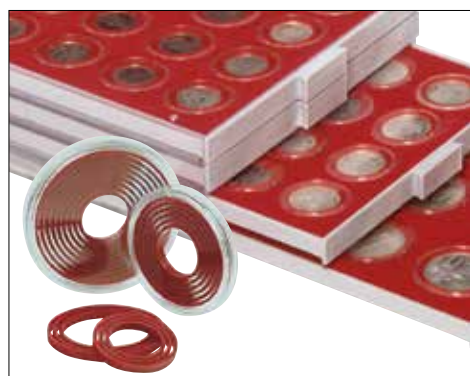

# COIN BOX INSERTS FOR COINS OR CAPSULES UP TO Ø 62 mm

Small coins, large coins, encapsulated coins and coins without coin capsules – you can collect almost limitless with our coin box inserts. Just two coin box variations but countless possibilities because: Inlets in two different sizes offer a maximum of flexibility and accuracy up to a diameter of 62 mm. The usage is very simple. Just lay the coin or the coin capsule on top of the inserts. Now you have to

break out the excess rings. So if you like to collect very different sizes of coins or coin capsules in one coin box, get with this the perfect system. LINDNER coin box inserts are available in red and winered, suitable for the coin boxes "Standard" and "Smoked glass".

**Material:** PP polypropylene

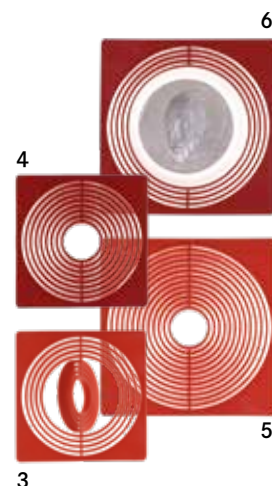

				MATCHING COIN BOX:		Quantity of compartments	
3	2236	Coin box inserts, small 51 x 51 mm	until Ø 45 mm	€ 14.50	2221	2621	20
4	2636				2213	2613	
5	2237	Coin box inserts, large 68 x 68 mm	until Ø 62 mm	€ 14.50	2213	2613	12
6	2637						

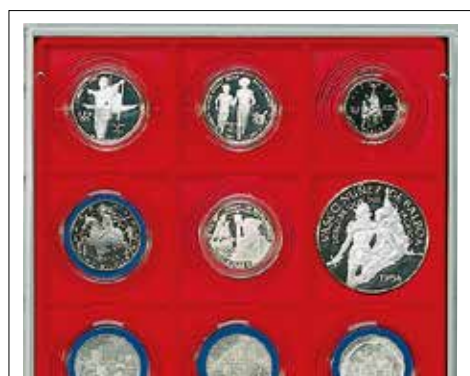

# COIN CAPSULES

## FOR COINS Ø 14 - 34,5 mm

Choose coin capsules for your valuable coin collection. The special scratch-resistant surface offers maximum protection as well as a "crystal clear" view of the coin.

Special production from 10.000 pieces.



					SUITED FOR:	MATCHING COIN BOX				Compartments
14 mm	20 mm	2,4 mm	2250014P	2251014	1/25 Oz Vienna Philharmonic (gold), 1/20 Oz Libertad / Panda (gold)					
15 mm	21 mm	2,45 mm	2250015P	2251015	1/20 Oz Lunar II / Maple Leaf / Kangaroo (gold)					
16 mm	22 mm	2,45 mm	2250016P	2251016						
16,5 mm	22,5 mm	2,55 mm	2250165P	2251165	1 €-Cent, 1/10 Oz Libertad / Maple Leaf / Vienna Philharmonic (gold), 1/10 Oz Libertad (silver)	2524	2924	---	---	48
17 mm	23 mm	2,5 mm	2250017P	2251017	1/10 Oz American Eagle / Britannia / Kangaroo / Krugerrand (gold), 1/10 Oz Britannia (silver)					
18 mm	24 mm	2,45 mm	2250018P	2251018	20 € "Deutscher Wald" (gold), 5 Marks Kaiserreich (gold), 5 Rappen					
19 mm	25,5 mm	2,5 mm	2250019P	2251019	2 €-Cent, 5 Pfennig, 50 Rappen, 1/10 Oz Panda / Lunar II (gold)					
20 mm	26 mm	2,5 mm	2250020P	2251020	10 €-Cent, 2 Pfennig, 10 Marks Kaiserreich (gold), 10 Crowns Austria (gold), 10 Rappen, 10 Vreneli CHF (gold)	2548	2948	---	---	48
21 mm	27 mm	2,5 mm	2250021P	2251021	50 Pfennig, 1/4 Oz "Luther Rose" 50 € (gold), 2 Rappen, 1/4 Oz Kangaroo / Maple Leaf (gold), 1/10 Oz Koala / Libertad (silver)					
21,5 mm	27,5 mm	2,75 mm	2250215P	2251215	5 €-Cent, 20 Crowns Austria (gold), 20 Rappen, 20 Vreneli CHF (gold)					
22 mm	28 mm	2,55 mm	2250022P	2251022	10 Pfennig					
22,5 mm	28,5 mm	2,6 mm	2250225P	2251225	20 €-Cent, 1 Pound Great Britain (gold), 1/4 Oz France (gold), 1/4 Oz American Eagle / Britannia / Krugerrand / Panda / Queen's Beasts / Vienna Philharmonic (gold), 1/4 Oz Britannia (silver)	2529	2929	---	---	42
23 mm	29 mm	2,75 mm	2250023P	2251023	20 Marks Kaiserreich (gold), 1/4 Oz Lunar II (gold), 1 Franc (silver)					
23,5 mm	29,5 mm	2,85 mm	2250235P	2251235	1 €, 1 CHF, 1/4 Oz Libertad (gold)					
24 mm	30 mm	2,85 mm	2250024P	2251024	1 DM, 1 DM (gold), 5 Austrian shillings					
24,5 mm	30,5 mm	2,75 mm	2250245P	2251245	50 €-Cent, 1 Marks Kaiserreich (silver), 25 Cent (USA, State Quarters)					
25 mm	31 mm	2,85 mm	2250025P	2251025	10 Roubles Alexander III, 1886-1894 (gold), 15 Roubles Nicholas II, 1897 (gold)	2530	2930	2530M	2530C	35
26 mm	32 mm	2,9 mm	2250026P	2251026	2 €, 10 Francs ab 1974, 1/2 Oz Kangaroo / Maple Leaf (gold), 1/4 Oz Panda (silver)					
27 mm	33 mm	2,9 mm	2250027P	2251027	2 DM, 2 Reichsmark (Ag/Cu), 50 Kopeek Nicholas II, 1895-1914 (silver)					
27,5 mm	33,5 mm	2,95 mm	2250275P	2251275	5 € Germany, 1/2 Oz American Eagle / Britannia / Krugerrand / Panda (gold), 1/4 Oz Libertad (silver), 1/2 Oz Britannia (silver)	2535	2935	---	---	35
28 mm	34 mm	3,0 mm	2250028P	2251028	50 Austrian shillings, 1996-2001 (Bi-metal), 20 Austrian shillings, 2 CHF, 50 Francs (gold)					
29 mm	35 mm	3,3 mm	2250029P	2251029	10 € Polymer Germany, 100 € commemorative coin Germany (gold), 2 Marks Kaiserreich (silver), 5 Francs from 1960 (silver), 1/2 Oz Vienna Philharmonic (gold)					
29,5 mm	35,5 mm	3,3 mm	2250295P	2251295	5 € Austria, 5 DM, 5 Marks/DDR (Cu/Ni), 1/2 Oz Libertad (gold)	2225	2625	---	---	35
30 mm	36 mm	3,3 mm	2250030P	2251030	2 Austrian shillings					
30,5 mm	36,5 mm	3,3 mm	2250305P	2251305	1 Oz Maple Leaf (gold), 25 €/50 € Germany "Teller Münze"					
31 mm	37 mm	3,3 mm	2250031P	2251031	3 Reichsmark (Ag/Cu), 25 Austrian shillings, 1/2 Oz Lunar II (gold), 100 Francs (silver)					
31,5 mm	38 mm	3,15 mm	2250315P	2251315	10 € France (silver), 1/2 Oz France (silver), 1 Roubels (Russia)	2537	2937	2537M	2537C	30
32 mm	38 mm	3,15 mm	2250032P	2251032	10 Marks/DDR (Cu/Ni), 5 CHF, 1 Oz Panda (gold)					
32,5 mm	37,5 mm	3,25 mm	2260325P	2261325	10 €/20 €/35 € Silver Germany (Special Capsule: Same as the original capsule 10 €/20 €/35 € proof silver coins Germany)					
32,5 mm	38,5 mm	2,7 mm	2250325P	2251325	10 €/20 €/35 € Silver Germany, 10 DM, 200 € gold coin, 1 Oz Niue Turtle (gold)					
33 mm	39 mm	3,2 mm	2250033P	2251033	1 Oz American Buffalo / American Eagle / Britannia / Kangaroo / Krugerrand / Queen's Beasts (gold)	2226	2626	2226M	2226C	30
33,5 mm	39,5 mm	3,35 mm	2250335P	2251335	3 Marks Kaiserreich (silver), 20 € France (silver), 3 Roubels (Cu/Ni), 5 Roubels Olympia (silver)					
34 mm	40,5 mm	3,25 mm	2250034P	2251034	100 Austrian shillings (gold), 20 CHF, 1/2 Oz Libertad (silver)					
34,5 mm	40,5 mm	3,25 mm	2250345P	2251345	Médailles Souvenirs, 3 € "Tiertaler" Austria, 1/2 Oz Maple Leaf / Panda (silver)	2224	2624	---	---	24

PRICE	€ 5.50	€ 41.50
-------	--------	---------



Coin capsule set  
for one €-coin set  
2250E € 6.00

	20 mm	22,5 mm	24,5 mm	23,5 mm	26 mm	27,5 mm	29 mm	32,5 mm
Pack of 10	2250020P	2250225P	2250245P	2250235P	2250026P	2250275P	2250029P	2250325P 2260325P
Pack of 100	2251020	2251225	2251245	2251235	2251026	2251275	2251029	2251325 2261325

# COIN CAPSULES

## FOR COINS Ø 35 - 51 mm



					SUITED FOR:	MATCHING COIN BOX		Compartment
35 mm	41 mm	3,25 mm	2250035P	2251035	20 US \$ Liberty (gold), 20 Francs (1929-1939), 100 Francs (gold), 1 Oz Libertad (gold)	2224	2624	24
35,5 mm	41,5 mm	3,4 mm	2250355P	2251355	100 Vreneli CHF (gold), 5 Roubels (Cu/Ni), 5 Roubels Alexander II, 1855-1881 (gold), 5 Roubels Alexander III, 1881-1885 (gold)	2103	2703	20
36 mm	42 mm	3,25 mm	2250036P	2251036	100 Austrian shillings (silver)	2544	2944	20
37 mm	43 mm	3,05 mm	2250037P	2251037	5 Reichsmark (Ag/Cu), 5 Francs until 1889 (silver), 1/2 Oz Koala / Lunar II (silver)	2220	2620	20
37,5 mm	44,5 mm	3,35 mm	2250375P	2251375		2544	2944	20
38 mm	44 mm	3,5 mm	2250038P	2251038	1 Oz Vienna Philharmonic (gold), 1 Oz Vienna Philharmonic (silver)			
38,5 mm	45,5 mm	3,5 mm	2250385P	2251385	5 Marks Kaiserreich (silver), 500 Austrian shillings (silver), 1 Oz Canadian Wildlife / Maple Leaf (silver)	2220	2620	20
39 mm	45 mm	3,25 mm	2250039P	2251039	1 Oz Krugerrand (silver), 1 Oz BIG FIVE, South Africa (silver)			
39,5 mm	45 mm	3,25 mm	2250395P	2251395	3 Roubles commemorative coin (silver)			
40 mm	46 mm	3,2 mm	2250040P	2251040	1 Oz Lunar II (gold), 10 Roubels Olympia (silver)			
40,5 mm	46,5 mm	3,5 mm	2250405P	2251405	1 Oz Britannia / Libertad / Niue Turtle (silver)			
41 mm	47 mm	3,25 mm	2250041P	2251041	1 Silver Dollar, 2 Oz Kangaroo (gold), 1 Oz American Eagle / Kangaroo / Koala / Kookaburra / Panda (silver)	2520	2920	20
42 mm	48 mm	3,5 mm	2250042P	2251042	50 € France (silver), 2 Oz Lunar II (gold)			
43 mm	49 mm	4,2 mm	2250043P	2251043		2543	2943	20
44 mm	50 mm	3,85 mm	2250044P	2251044				
45 mm	51 mm	4,25 mm	2250045P	2251045		2515	2915	15
46 mm	52,5 mm	4,1 mm	2250046P	2251046	1 Oz Lunar II (silver)			
47 mm	53 mm	4,25 mm	2250047P	2251047		2554	2954	12
48 mm	54 mm	4,45 mm	2250048P	2251048	100 € France (silver)			
49 mm	55 mm	4,35 mm	2250049P	2251049	2 Oz Libertad (silver)			
50 mm	56 mm	4,25 mm	2250050P	2251050		2212	2612	12
51 mm	57 mm	4,90 mm	2250051P	2251051				
PRICE			€ 6.50	€ 48.00				



## RECTANGULAR COIN CAPSULES

Suited for 1 Oz Australia bullion (Silver coin bars).

Internal measurements:

27 x 47 x 3 mm

External measurements:

34 x 54 x 6,5 mm

PACK OF 10

22552747P

€ 8.50

## COIN CAPSULES FOR BIGGER AND THICKER COINS

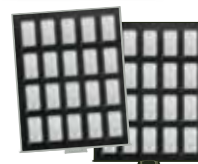

Suitable coin boxes for rectangular coin capsules can be found on page 9.

							SUITED FOR:
20,1 mm	26,3 mm	4,5 mm	8,5 mm	---	22702010P / € 22.50	---	
24,1 mm	30,3 mm	4,5 mm	7,8 mm	---	22702410P / € 22.50	---	
35,45 mm	40,56 mm	5,07 mm	8,7 mm	---	22703545P / € 22.50	---	
38,4 mm	45 mm	4,5 mm	7,3 mm	---	2255384P / € 12.50	2255384 / € 84.00	1 1/2 Oz Canadian Wildlife Polarbear / Polarfox (silver), 1 1/4 Oz Canadian Wildlife Bison (silver)
39 mm	45 mm	6 mm	8,6 mm	---	2255039P / € 12.50	2255039 / € 84.00	2 Oz Queen's Beasts / Canadian Goose (silver)
40,4 mm	44,8 mm	6,6 mm	10,3 mm	---	22704040P / € 22.50	---	
41 mm	47 mm	5,5 mm	7,6 mm	---	2255041P / € 12.50	---	2 Oz Piedfort Koala / Niue Turtle (silver)
45 mm	50,6 mm	4,8 mm	9,0 mm	---	22704500P / € 22.50	---	
50,3 mm	55,8 mm	8,5 mm	11,6 mm	---	22705030P / € 22.50	---	5 Oz France (silver)
55 mm	60,1 mm	3,2 mm	6,6 mm	22705500 / € 6.50	---	---	2 Oz Kookaburra (silver)
60 mm	65,1 mm	5,3 mm	9,0 mm	22706000 / € 6.50	---	---	2 Oz Lunar II (silver), 5 Oz Panda (gold)
65 mm	69,8 mm	5,4 mm	9,5 mm	22706500 / € 6.50	---	---	5 Oz Koala / Libertad / Lunar II / Niue Turtle (silver)
70 mm	74,5 mm	5,5 mm	9,3 mm	22707000 / € 6.50	---	---	12 Oz Panda (gold)
80 mm	87,1 mm	5,7 mm	10,5 mm	22708000 / € 7.50	---	---	1 kg Kangaroo (gold), 10 Oz Lunar II (gold), 10 Oz Koala, Kookaburra (silver)
100 mm	110,5 mm	8,5 mm	13,8 mm	22710000 / € 7.50	---	---	1 kg Queen's Beasts (silver)
101,3 mm	110 mm	13,2 mm	20,1 mm	22500439 / € 20.50	---	---	1 kg Lunar I/II (gold), 1 kg Arche Noah (silver)
120 mm	130 mm	9,2 mm	13,4 mm	22712000 / € 7.50	---	---	

For coins with a thickness of 6,5 mm or more, we recommend collecting in LINDNER d-Boxes (see page 10).

Prices do not include contents / display material. All prices and specifications are subject to change without prior notice.

# HARTBERGER® COIN HOLDERS AND ACCESSORIES

Coin holders from HARTBERGER® offer a different storage solution for the coin collector. Popular for many years, they are very easy to use: Place coin on the one side of the frame and fold together. HARTBERGER® Coin holders are made of cardboard and softener-free foil. They are available either self-adhesive or non-adhesive (needs to be stapled).

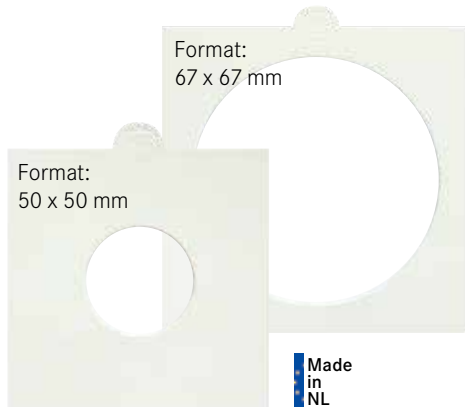

	SELF-ADHESIVE 50 x 50 mm			NON ADHESIVE 50 x 50 mm		
	25x	100x	1000x	25x	100x	1000x
15 mm	8320015	8322015	8321015	8330015	8332015	8331015
17,5 mm	8320175	8322175	8321175	8330175	8332175	8331175
20 mm	8320020	8322020	8321020	8330020	8332020	8331020
22,5 mm	8320225	8322225	8321225	8330225	8332225	8331225
25 mm	8320025	8322025	8321025	8330025	8332025	8331025
27,5 mm	8320275	8322275	8321275	8330275	8332275	8331275
30 mm	8320030	8322030	8321030	8330030	8332030	8331030
32,5 mm	8320325	8322325	8321325	8330325	8332325	8331325
35 mm	8320035	8322035	8321035	8330035	8332035	8331035
37,5 mm	8320375	8322375	8321375	8330375	8332375	8331375
39,5 mm	8320395	8322395	8321395	8330395	8332395	8331395
assorted	8320000	---	---	---	---	---
Price	€ 5.80	€ 18.90	€ 142.50	€ 4.80	€ 13.90	€ 82.50

HARTBERGER® Coin holders with **oval cutting** for Pressed Pennies

	SELF-ADHESIVE 50 x 50 mm			NON ADHESIVE 50 x 50 mm		
	25x	100x	1000x	25x	100x	1000x
38 x 24 mm	8320243	8322243	8321243	8330243	8332243	8331243
Price	€ 5.80	€ 18.90	€ 142.50	€ 4.80	€ 13.90	€ 82.50

	SELF-ADHESIVE 67 x 67 mm			NON ADHESIVE 67 x 67 mm		
	25x	100x	1000x	25x	100x	1000x
40 mm	8320040	---	8321040	8330040	---	8331040
43 mm	8320043	---	8321043	8330043	---	8331043
48 mm	8320048	---	8321048	8330048	---	8331048
53 mm	8320053	---	8321053	8330053	---	8331053
Price	€ 14.00	---	€ 280.00	€ 9.50	---	€ 170.00

# HARTBERGER® RING BINDER AND COIN PAGES

## RING BINDER BIG

**Ring binder LUXUS, blue**  
Synthetic material padded and welded,  
Format: 310 x 280 x 50 mm  
Mechanism: 4-ring, 80/80/80 mm  
83300-B

€ 24.00

**Companion Set: Ring binder LUXUS with Slipcase, blue** 833008301-B

€ 44.50

**Ring binder STANDARD, blue**  
Synthetic material unpadded and welded,  
Format: 310 x 280 x 50 mm  
Mechanism: 4-ring, 80/80/80 mm

83304-B

€ 19.50

**Companion Set: Ring binder STANDARD with Slipcase, blue** 833048301-B

€ 40.00

**Slipcase for Ring binder 8300 and 8304, blue**  
Format: 315 x 285 x 55 mm

83301-B

€ 24.00

## RING BINDER SMALL

**Ring binder LUXUS, blue**  
Synthetic material padded and welded,  
Format: 235 x 235 x 45 mm  
Mechanism: 4-ring, 45/65/45 mm

83200-B

€ 20.50

**Companion Set: Ring binder LUXUS with Slipcase, blue** 832008201-B

€ 39.50

**Slipcase for Ring binder 8200, blue**  
Format: 240 x 240 x 50 mm

83201-B

€ 20.50

## HARTBERGER® Coin pages BIG (Format: 245 x 285 mm)

Suited for 20 coin holders 50 x 50 mm, Pack of 10	8310	€ 13.50
Suited for 20 coin holders 50 x 50 mm, SUPER PLUS**, Pack of 10	8311SP	€ 18.50
Suited for 9 coin holders 67 x 67 mm, SUPER*, Pack of 10	8312	€ 18.50
Suited for 12 coin holders 50 x 50 mm, SUPER*, Pack of 10	8308	€ 18.50
Plain white cards, size 20 x 50 mm, for identification purposes etc. for pages 8308, Pack of 120	8309-7	€ 2.00
Black Interleaving Pages, Pack of 10	8318	€ 7.00

## HARTBERGER® System pages BIG (Format: 240 x 300 mm)

with 1 pocket (226 x 295 mm), Pack of 5	HB-S-1	€ 9.50
with 2 strips (226 x 147 mm), Pack of 5	HB-S-2	€ 9.50
with 3 strips (226 x 97 mm), Pack of 5	HB-S-3	€ 9.50
with 4 strips (226 x 73 mm), Pack of 5	HB-S-4	€ 9.50

## HARTBERGER® Coin pages SMALL (Format: 185 x 225 mm)

Suited for 12 coin holders 50 x 50 mm, Pack of 10	8210	€ 13.50
Suited for 12 coin holders 50 x 50 mm, SUPER*, Pack of 10	8211	€ 18.50
Suited for 6 coin holders 67 x 67 mm, SUPER*, Pack of 10	8212	€ 18.50
Black Interleaving Pages, Pack of 10	8218	€ 7.00

\*SUPER = reinforced holes / \*\*SUPER PLUS = reinforced holes, extra +/- 30% thicker foil



**HARTBERGER® ASSORTI-BOX**

1200 coin holders in a box; (335 x 185 x 120 mm)  
Assortment: each 100x 15,0 mm, 17,5 mm,  
20,0 mm, 25,0 mm, 27,5 mm, 30,0 mm, 32,5 mm,  
35,0 mm, 37,5 mm, 39,5 mm and 200 x 22,5 mm.  
☛ 8323 Self-adhesive € 173.50  
☛ 8325 Non adhesive € 94.50

**HARTBERGER® ASSORTI-BOX EURO**

500 coin holders in a box; (285 x 105 x 120 mm).  
Assortment: each 100x 17,5 mm, 20,0 mm,  
22,5 mm, 25,0 mm and 27,5 mm.  
☛ 8324 Self-adhesive € 89.50

**STAPLER**

for HARTBERGER® Coin holders, chrome  
(staples not included).  
☛ 8340 € 18.00

**STAPLES, ZINC-PLATED**

Pack of 1000  
☛ 8341 € 5.00

**LINDNER ACCESSORIES**

FOR HARTBERGER® COIN HOLDERS

**COIN BOX**

(see page 8)

- 2122
- 2722
- 2122M
- 2122C

Made in Germany

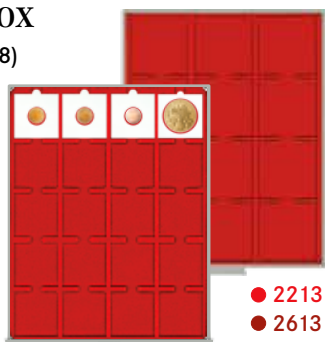

- 2213
- 2613

COIN BOX

€ 25.50

**POCKET ALBUM FOR 60 COIN HOLDERS**

Handy pocket album with padded dark blue cover. With 10 crystal clear synthetic sleeves suitable for 6 coin holders 50 x 50 mm each.

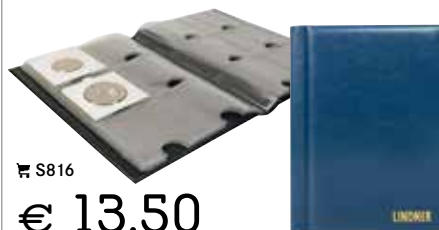

☛ S816

€ 13.50



Made in Germany

€ 44.50

☛ 2245

**WOOD BOX FOR COIN HOLDERS**

(see page 17)



**NERA CASE XL**

for 60 Coin holders  
(see page 27)



- 2365-2122E
- 2365-2722E
- 2365-2122ME
- 2365-2122CE

NERA XL

€ 86.50

**LARGE COIN CARRYING CASE**

for 120 Coin holders  
(see page 20)



COIN CARRYING CASES

€ 65.50

- 2338-120
- 2338M-120

**SOLID WOOD CASE CARUS-4**

for 80 Coin holders  
(see page 29)

Made in Germany



CARUS-4

€ 95.50

- 2494-3
- 2494-3M

**NERA CASE M**

for 20 Coin holders  
(see page 26)

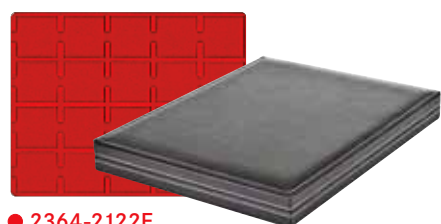

- 2364-2122E
- 2364-2722E
- 2364-2122ME
- 2364-2122CE

NERA M

€ 49.50

**LARGE ALU-COIN CASE**

for 75 Coin holders  
(see page 21)



COIN CARRYING CASES

€ 57.50

- S2340-75
- S2340M-75

**SOLID WOOD CASE CARUS-1**

for 20 Coin holders  
(see page 28)

Made in Germany



CARUS-1

€ 43.50

- S2491-2722E
- S2491-2122ME

# COIN CAPSULES CARRÉE

## FOR COINS Ø 14 - 41 mm



Format:  
50 x 50 mm

The uniform external format (50 x 50 mm) of the coin capsule offers the option of collecting coins of different diameters in one collecting system. The softener and acid free block-foam inserts are available in diameters from a size of 14 mm to 41 mm – for all current coins.

The coin capsules are extremely scratch resistant and provide the perfect protection and a “crystal clear” view of your coins. In addition to the robust material, the protective rim on the bottom and the lid of the capsule prevent scratching of the capsules.

14,0 mm	€ 2240014	28,0 mm	€ 2240028
15,0 mm	€ 2240015	29,0 mm	€ 2240029
16,0 mm	€ 2240016	30,0 mm	€ 2240030
17,0 mm	€ 2240017	31,0 mm	€ 2240031
18,0 mm	€ 2240018	32,0 mm	€ 2240032
19,0 mm	€ 2240019	33,0 mm	€ 2240033
20,0 mm	€ 2240020	34,0 mm	€ 2240034
21,0 mm	€ 2240021	35,0 mm	€ 2240035
22,0 mm	€ 2240022	36,0 mm	€ 2240036
23,0 mm	€ 2240023	37,0 mm	€ 2240037
24,0 mm	€ 2240024	38,0 mm	€ 2240038
25,0 mm	€ 2240025	39,0 mm	€ 2240039
26,0 mm	€ 2240026	40,0 mm	€ 2240040
27,0 mm	€ 2240027	41,0 mm	€ 2240041

One package consists out of 4 coin capsules CARRÉE incl. one 3 mm thick inlay each. Made of a black softener and acid free block-foam. For the accurate storage of the coins!

Pack of 4 € 5.50

### NERA XM / NERA S

NERA Case XM for 12 CARRÉE or  
NERA Case S for 4 CARRÉE  
(see page 24-25)



NERA XM  
● 2363-12  
€ 36.50

NERA S  
● 2362-4  
€ 29.50

### NERA CASE M PLUS - WITH WINDOW

NERA Case M PLUS - with window for  
20 CARRÉE (see page 26)



● 2367-2122E  
● 2367-2722E  
● 2367-2122ME  
● 2367-2122CE  
NERA M PLUS  
€ 51.50

### NERA XL

NERA Case XL for 60 CARRÉE  
(see page 27)



● 2365-2122E  
● 2365-2722E  
● 2365-2122ME  
● 2365-2122CE  
NERA XL  
€ 86.50

### NERA M

NERA Case M for 20 CARRÉE  
(see page 26)



● 2364-2122E  
● 2364-2722E  
● 2364-2122ME  
● 2364-2122CE  
NERA M  
€ 49.50

### NIMBUS DISPLAY FRAMES

For presentation of one coin in a coin capsule CARRÉE. Open the NIMBUS frame and put the coin capsule into the recess. After that, close the NIMBUS frame. A magnetic closure holds th frame together.



NIMBUS  
● 4834  
€ 7.50

### COIN BOX

Coin box for 20 CARRÉE  
(see page 8)

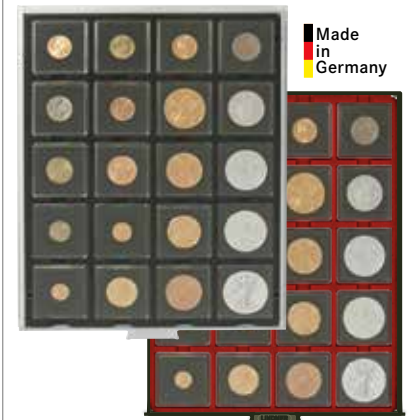

● 2122  
● 2722  
● 2122M  
● 2122C  
COIN BOX  
€ 25.50

# WOOD BOX

## FOR COIN HOLDERS / CARRÉE

Dark stained authentic wood box with 4 solid closures and a removable lid. With 15 fixed compartments 52 x 68 mm. Suited for approx. 400 Coin holders 50 x 50 mm or 135 Coin capsules CARRÉE. Format: 295 x 230 x 85 mm



€ 2245



Made in Germany

€ 44.50

# SOLID WOOD COIN CASE

Solid Wood Case for 100 CARRÉE (see page 30)



Made in Germany

- S2495-S2122ME
- S2495-S2122CE

€ 69.50

# CARUS-4

Solid Wood Case CARUS-4 for 80 CARRÉE (see page 29)



Made in Germany



- 2494-3
- 2494-3M
- 2494-2122CE

CARUS-4

€ 95.50

# CARUS-1

Solid Wood Case CARUS-1 for 20 CARRÉE (see page 28)



Made in Germany

- S2491-2722E
- S2491-2122ME

CARUS-1

€ 43.50

# NIMBUS DISPLAY FRAMES

Give your favourite collectables that "special look" Details as well as the complete assortment of NIMBUS-Frames can be found on pages 106-107.

LOOKS LIKE THE OBJECTS ARE FLOATING



## STORAGE SYSTEMS FOR SLABS



Slabs up to a size of 63 x 85 mm (PCGS/NGC).

### ALU-CASE FOR 30 SLABS

Compact case in aluminium-design with foamed inserts for max. 30 Slabs.

Handle in the middle of the lid.

Format:  
245 mm x 180 mm (incl. closures) x  
125 mm (incl. handle)

☛ S2330

ALU-CASE

€ 45.50



### COIN BOX FOR 9 SLABS

(see page 9)



Made in Germany

COIN BOX

€ 25.50

● 2219  
● 2619  
● 2219M

### CARUS-4

Solid Wood Case  
CARUS-4 for  
36 Slabs  
(see page 29)

Made in Germany



CARUS-4

€ 95.50

● 2494-19  
● 2494-19M



### CARUS-1

Solid Wood Case  
CARUS-1 for  
9 slabs  
(see page 28)

Made in Germany



CARUS-1

€ 43.50

● S2491-2619E  
● S2491-2219ME



### NERA M PLUS - WITH WINDOW

NERA M PLUS Case with window for 9 Slabs  
(see page 26)



NERA M PLUS

€ 51.50

● 2367-2219E  
● 2367-2619E  
● 2367-2219ME

### NERA XL

NERA XL Case for 27 Slabs  
(see page 27)



NERA XL

€ 86.50

● 2365-2219E  
● 2365-2619E  
● 2365-2219ME

### NERA M

NERA M Case for 9 Slabs  
(see page 26)



NERA M

€ 49.50

● 2364-2219E  
● 2364-2619E  
● 2364-2219ME

### COIN CARRYING CASES

(see page 23)



COIN CARRYING CASES

€ 59.50

● S2307-S2219ME

### NIMBUS ECO

(see page 106-107)



NIMBUS ECO

€ 15.50

● 4836-B  
● 4836-S  
○ 4836-WS

### NIMBUS 230

(see page 106-107)



NIMBUS 230

€ 39.50

● 4831  
○ 4851

# COLLECTION CASE MULTI

## ALL ROUNDER FOR DIFFERENT AREAS OF COLLECTION

The universal case for many different collection areas with many application options. Enthusiasts and collectors of commemorative coin sets and postcards have a perfect opportunity to store their collections in this case. With its 6 compartment dividers, the object can be sorted and viewed ideally.

## COLLECTION CASE ALU MULTI PLUS

Lockable case for commemorative coin sets, postcards, letters, stamps in stock cards. The interior with 6 fixed compartments is covered with a noble, black velour flock.

With foldable carrying handle inserted into the center of the lid. Lid is removable!

**Also suitable for receipts or stock cards in A5 format or for certified banknotes!**

Material: Aluminium, silver

Format: 240 x 200 x 360 mm

Suited for: Objects up to 170 x 220 mm

☛ S2332

€ 59.50

Stock cards A5 see page 87.



REMOVABLE  
LID

## COLLECTION CASE ALU MULTI

Lockable case for commemorative coin sets, postcards, letters, stamps in stock cards. The interior with 6 fixed compartments is covered with a noble, black velour flock.

With foldable carrying handle inserted into the center of the lid. Lid is removable!

Lid is removable!

**Ideal also for the original 20 Euro collectors coin sets!**

Material: Aluminium, silver

Format: 200 x 200 x 360 mm

Suited for: Objects up to 170 x 180 mm

☛ S2331

€ 53.00

# TRAYS FOR COIN CARRYING CASES

Extremely solid trays, covered with red or dark blue velour all around. Suitable for the large coin carrying case, the ALU coin case and the MAGNUS coin case. Format: 331 x 220 x 9 mm

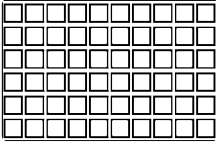
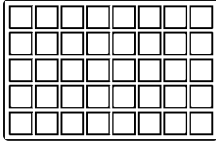
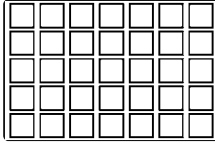
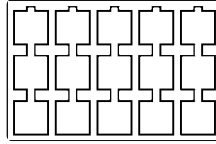
					
<b>77x Ø 24 mm</b>	<b>60x Ø 27 mm</b>	<b>40x Ø 34 mm</b>	<b>35x Ø 39 mm</b>	<b>24x Ø 45 mm</b>	<b>15x Ø 50 mm</b>
● <b>2329-77</b> ● <b>2329M-77</b>	● <b>2329-60</b> ● <b>2329M-60</b>	● <b>2329-40</b> ● <b>2329M-40</b>	● <b>2329-35</b> ● <b>2329M-35</b>	● <b>2329-24</b> ● <b>2329M-24</b>	● <b>2329-15</b> ● <b>2329M-15</b>
€ 6.90	€ 6.90	€ 6.90	€ 6.90	€ 6.90	€ 6.90

## LARGE COIN CARRYING CASE

Collecting case in an elegant, black aluminium design. The matching trays are very sturdy and entirely covered in red or dark blue velour which ensures easy handling. The eight synthetic feet ensure stability and protects the table, the shelf, etc from scratches. The case is lockable.

Format: 350 x 240 x 89 mm



### WITH 8 MIXED COIN TRAYS

for 355 coins

#### ASSORTEMENT:

- 1x 77x Ø 24.0 mm
  - 2x 60x Ø 27.0 mm
  - 1x 40x Ø 34.0 mm
  - 2x 35x Ø 39.0 mm
  - 2x 24x Ø 45.0 mm
- **2338** ● **2338M**

€ 65.50

### WITH 8 IDENTICAL COIN TRAYS

for 616 coins

8x 77x Ø 24.0 mm

- **2338-616** ● **2338M-616**

for 480 coins

8x 60x Ø 27.0 mm

- **2338-480** ● **2338M-480**

for 320 coins

8x 40x Ø 34.0 mm

- **2338-320** ● **2338M-320**

for 280 coins

8x 35x Ø 39.0 mm

- **2338-280** ● **2338M-280**

for 192 coins

8x 24x Ø 45.0 mm

- **2338-192** ● **2338M-192**

for 120 coins

8x 15x Ø 50.0 mm

- **2338-120** ● **2338M-120**

each € 65.50

### WITH 8 COIN TRAYS OF YOUR CHOICE

Please quote the order-no. of the selected trays when placing your order.

- **2338NW** ● **2338MNW**

€ 71.50

### EMPTY (without trays)

Interior colour: black

- **2338o-S**

€ 39.90

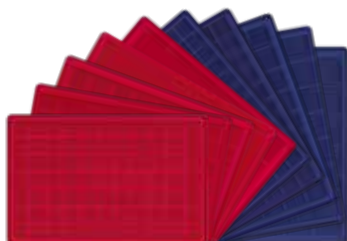

# LARGE ALU-COIN CASE

Lockable coin case in noble aluminium-design with 5 coin trays. The trays are extremely stable and are covered with red or dark blue velour. The synthetic feet enable it to stand securely and protects the table, the shelf etc. from being scratched.

Format: 350 x 240 x 63 mm

**WITH 5  
COIN  
TRAYS**



## WITH 5 MIXED COIN TRAYS

for 236 coins

### ASSORTEMENT:

1x 77x Ø 24.0 mm

1x 60x Ø 27.0 mm

1x 40x Ø 34.0 mm

1x 35x Ø 39.0 mm

1x 24x Ø 45.0 mm

● S2340 ● S2340M

€ 57.50

## WITH 5 IDENTICAL COIN TRAYS

for 385 coins

5x 77x Ø 24.0 mm

● S2340-385 ● S2340M-385

for 300 coins

5x 60x Ø 27.0 mm

● S2340-300 ● S2340M-300

for 200 coins

5x 40x Ø 34.0 mm

● S2340-200 ● S2340M-200

for 175 coins

5x 35x Ø 39.0 mm

● S2340-175 ● S2340M-175

for 120 coins

5x 24x Ø 45.0 mm

● S2340-120 ● S2340M-120

for 75 coins

5x 15x Ø 50.0 mm

● S2340-75 ● S2340M-75

each € 57.50

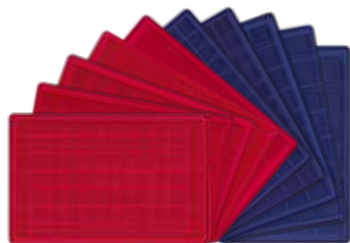

## WITH 5 COIN TRAYS OF YOUR CHOICE

Please quote the order-no. of the selected trays when placing your order.

● S2340NW ● S2340MNW

€ 59.90

**EMPTY (without trays)**  
Interior colour: black  
● S2340o

€ 39.90

# ALU CARRYING CASE MAGNUS

Large, lockable coin case in noble aluminium design. The synthetic feet enable it to stand securely and protects the table, the shelf etc. from being scratched. The two additional locks at both sides of the case, ensure that the case remains firmly closed during transportation.

Format: 370 x 260 x 200 mm

Capacity: max. 17 trays

**MAX. 17  
TRAYS**



## WITH 10 COIN TRAYS OF YOUR CHOICE

Please quote the order-no. of the selected trays when placing your order.

☒ 2317NW

€ 89.50

Fitting trays  
see page 20.

**EMPTY (without trays)**  
Interior colour: light red

☒ 2317o

€ 63.50

## COIN BOX CARRYING CASES

The practical LINDNER Coin box carrying cases are made to a high quality and they are lockable. You can stack your coin boxes and collecting boxes which are designed to help save space as you can stack your coin boxes and collection boxes in these carry cases. You can use them for transportation purposes or for permanent storage at home.



☛ 2310

€ 109.50

### COIN BOX CARRYING CASE NERA MB 10

NERA MB 10 offers space for 10 coin boxes and is lockable. Timeless elegance, a clear design, versatility, functionality and most of all a special touch. These are the magnificent features of our NERA series. The grained surface in leather-effect with the crème-coloured stitching grants this carrying case its individual character. The double-wing doors ensure safe and simple handling, all the while offering protection for your coin boxes. With these new features in material and functionality, NERA MB 10 offers perfect conditions for storage or transportation of your coin boxes.

Suited for: 10 coin boxes  
Format: 265 x 325 x 255 mm  
4 synthetic feet

☛ 2310

€ 109.50

### COIN BOX CARRYING CASE “ALUMINIUM” MB 10

**A LINDNER Coin box carrying case in new design**  
The coin box carrying case offers space for 10 coin boxes or 5 collection boxes and is lockable. The double-wing doors ensure a safe and simple handling, all the while offering protection for your coin boxes or collection boxes.

Suited for: 10 coin boxes or 5 collection boxes  
Format: 255 x 340 x 255 mm  
4 synthetic feet

☛ 2312

€ 99.50



☛ 2312

€ 99.50

### COIN BOX CARRYING CASE “ALUMINIUM”

Case made of aluminium. The inside is lined with red velvet and has a handle on the top.

Suited for:  
8 coin boxes or 4 collection boxes  
Format: 260 x 340 x 200 mm  
4 synthetic feet

☛ 2358

€ 99.50

☛ 2358

€ 99.50



### COIN BOX CARRYING CASE COMPACT

Lockable Coin box carrying case covered with black leatherette. The inside is lined with black velvet. Can be stacked without any problems, because of the foldable carrying handle in the middle of the top.

Suited for:  
8 coin boxes or 4 collection boxes  
Format: 255 x 345 x 220 mm  
4 synthetic feet

☛ 2319

€ 99.50



☛ 2319

€ 99.50



# COIN CASE ALU

Lockable ALU Coin case for 6 black or dark blue coin trays.

Format: 305 x 265 x 75 mm

WITH 6 COIN TRAYS



## WITH 6 MIXED COIN TRAYS

for 177 Coins

### ASSORTEMENT:

- 1x 48x Ø 30.0 mm
- 1x 35x Ø 36.0 mm
- 1x 30x Ø 38.0 mm
- 1x 24x Ø 42.0 mm
- 2x 20x Ø 47.0 mm

- S2307-177
- S2307-177M

€ 59.50

EMPTY (without trays)  
Interior colour: black  
● S2307o

€ 39.90

## COIN CASE ALU WITH 6 IDENTICAL COIN TRAYS:

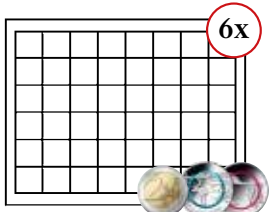
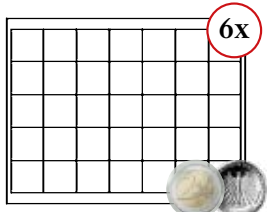
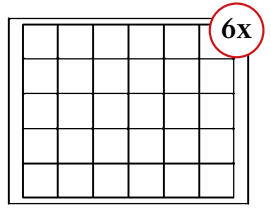
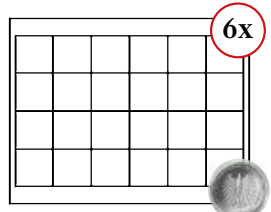
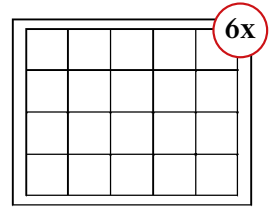
 <p>6x</p>	 <p>6x</p>	 <p>6x</p>	 <p>6x</p>	 <p>6x</p>
<p>Ø 30 mm 288x</p> <ul style="list-style-type: none"> <li>● S2307-S2148CE</li> <li>● S2307-S2148ME</li> </ul>	<p>Ø 36 mm 210x</p> <ul style="list-style-type: none"> <li>● S2307-S2135CE</li> <li>● S2307-S2135ME</li> </ul>	<p>Ø 38 mm 180x</p> <ul style="list-style-type: none"> <li>● S2307-S2115CE</li> <li>● S2307-S2115ME</li> </ul>	<p>Ø 42 mm 144x</p> <ul style="list-style-type: none"> <li>● S2307-S2124CE</li> <li>● S2307-S2124ME</li> </ul>	<p>Ø 47 mm 120x</p> <ul style="list-style-type: none"> <li>● S2307-S2120CE</li> <li>● S2307-S2120ME</li> </ul>

each € 59.50

## COIN CASE ALU FOR 36 SLABS

Format: 305 x 265 x 75 mm



WITH 4 COIN TRAYS

Scope of delivery: 4 blue coin trays with 9 square compartments each. The coin inserts are covered with high-quality velour.

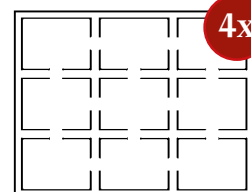

- 63 x 85 mm 36x
- S2307-S2219ME

€ 59.50

# NERA SERIES

## FOR STORING COINS AND OTHER TREASURES IN A NEW DESIGN

Timeless elegance, a clear design, versatility, functionality and most of all, a special touch – these are the magnificent features of our NERA series. The grained structure of the material in conjunction with the crème coloured stitching

grants this series its individual character. The graphite coloured and padded lining of the lid of each NERA case provides an attractive contrast to the inserts and your coins. With the many different sizes and different colour inserts

available, the NERA series is the perfect choice for single coins or a complete collection, leaving nothing to be desired.

## NERA XS

The smallest version of this series is designed to display that special coin. Whether you are looking for a suitable spot for your favourite collectible or for elegant packaging for a coin gift: our NERA XS offers a variety of purposes. The black velour-like coin insert is a perfect complement to silver or gold coins.

Format: 98 x 88 x 42 mm

### NERA Case XS incl. coin capsule

Comes with one capsule which features adjustable distance rings. The red rings can be adjusted to the size of the coin. For coin sizes Ø 16-51 mm.

☞ 2360 € 24.50

### NERA Case XS incl. insert with concave indentation

Suited for coins up to Ø 60 mm.

☞ 2361 € 23.50

### NERA Case XS incl. patented form-adaptive insert

With patented "push in"-insert in which you can place any coin up to Ø 70 mm.

☞ 2366 € 25.50

## NERA S

NERA Case S – A stylish storage for sets of 4 or 5 coins. Choose between 4 square compartments for coins or capsules up to Ø 52 mm or 5 square compartments for coins or capsules up to Ø 40 mm. The coin inserts display silver as well as gold coins which is enhanced by a black, velour-like surface.

Format: 243 x 77 x 38 mm

With 4 square compartments for coins or coin capsules up to Ø 52 mm.

☞ 2362-4 € 29.50

With 5 square compartments for coins or coin capsules up to Ø 40 mm.

☞ 2362-5 € 29.50

Coin case with a foam insert "BLACK VELVET" with 5 round compartments incl. 5 LINDNER coin capsules.

NERA Case S for 5x 5 € collector coins Germany (incl. coin capsules).

☞ S2362-5EK € 29.50

NERA Case S for 5x 10 € collector coins Germany with polymer ring (incl. coin capsules).

☞ S2362-10EK € 29.50



# NERA XM

Our NERA Case XM is the perfect solution for storing 12 or 15 coins. Choose between 12 square compartments for coins or coin capsules up to Ø 52 mm or 15 square compartments for coins or capsules up to Ø 40 mm. The coin inserts with a black, velour-like surface, display silver as well as gold coins.

Format: 243 x 187 x 38 mm

With 12 square compartments for coins or coin capsules up to Ø 52 mm.

☛ 2363-12 € 36.50

With 15 square compartments for coins or coin capsules up to Ø 40 mm.

☛ 2363-15 € 36.50

☛ 2363-15



☛ 2363-12



NERA VARIUS PLUS

€ 82.50

# NERA VARIUS PLUS

One for all - the VARIUS PLUS collection cases were developed for the NERA series to hold larger objects and collectibles. With an inside height of 60 mm and the light red or dark red inserts which are partly adjustable, VARIUS PLUS can be adjusted to fit your needs.

Format: 300 x 244 x 80 mm

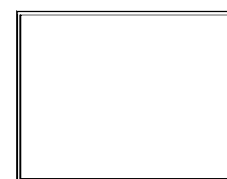

220 x 280 mm

● 2369-2401E

● 2369-2461E



220 x 280 mm

● 2369-2418E

Foam insert with velvet-like surface to stick PINS / Medals / Emblems.

These inserts have either 2 or 3 horizontal compartments and come with matching red dividers. You can customise each compartment and adjust the size any time to suit your needs.

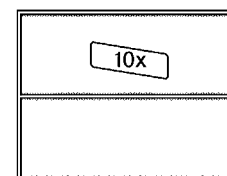

2x 105 x 280 mm

● 2369-2402E

● 2369-2462E

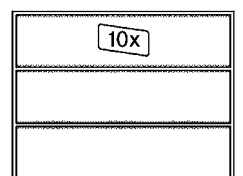

3x 65 x 280 mm

● 2369-2403E

● 2369-2463E

# NERA M

This case offers you the possibility of choosing different inserts from our large assortment of light red, dark red, dark blue or black coin box inserts.

Format: 298 x 243 x 35 mm

NERA Case M

€ 2364-... (+ with insert of your choice\*)



For thicker coins/coin capsules from a height of 6,5 mm, we recommend collecting in coin cases with d-box inserts (see page 31) or in LINDNER d-boxes (see page 10).

## THE VERSATILE CASES:

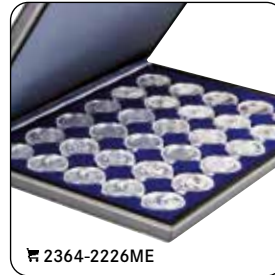

# NERA M PLUS

NERA Case M PLUS - with window

€ 2367-... (+ with insert of your choice\*)

€ 2364-2122ME



€ 2364



NERA M PLUS

€ 51.50

NERA M

€ 49.50



\* Sketches of the most popular NERA case coin inserts as well as the available colours are illustrated here. Please quote the order-no. of the selected tray when placing your order. Format: 285 x 225 mm.

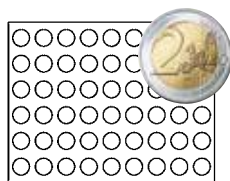

Ø 25.75 mm 54x

- ...-2154E
- ...-2754E
- ...-2154ME
- ...-2154CE

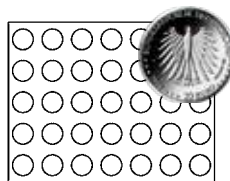

Ø 32.5 mm 35x

- ...-2111E
- ...-2711E
- ...-2111ME
- ...-2111CE

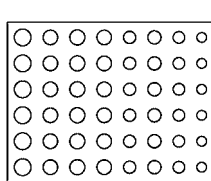

6x Current coin set

- ...-2506E
- ...-2906E
- ...-2506ME
- ...-2506CE

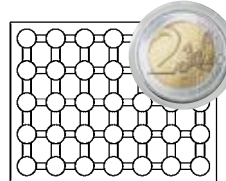

Ø 32 mm 35x

- ...-2530E
- ...-2930E
- ...-2530ME
- ...-2530CE

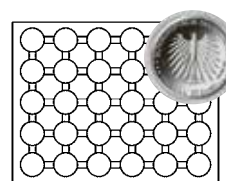

Ø 37.5 mm 30x

- ...-2537E
- ...-2937E
- ...-2537ME
- ...-2537CE

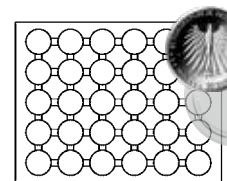

Ø 39.5 mm 30x

- ...-2226E
- ...-2626E
- ...-2226ME
- ...-2226CE

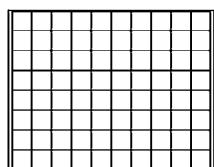

24 x 24 mm 80x

- ...-2180E
- ...-2780E
- ...-2180ME
- ...-2180CE

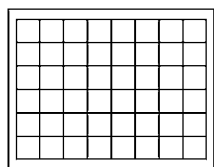

30 x 30 mm 48x

- ...-2148E
- ...-2748E
- ...-2148ME
- ...-2148CE

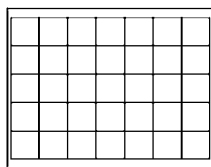

36 x 36 mm 35x

- ...-2135E
- ...-2735E
- ...-2135ME
- ...-2135CE

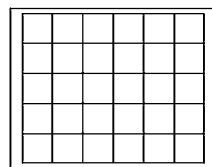

38 x 38 mm 30x

- ...-2115E
- ...-2715E
- ...-2115ME
- ...-2115CE

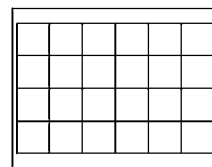

42 x 42 mm 24x

- ...-2124E
- ...-2724E
- ...-2124ME
- ...-2124CE

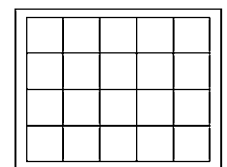

47 x 47 mm 20x

- ...-2120E
- ...-2720E
- ...-2120ME
- ...-2120CE

# NERA XL

Our NERA XL with three trays was developed especially for larger collections and series. The single trays harmonize in colour and design with the case and allow for perfect stacking inside the case. You can choose between our wide assortment of light red, dark red, dark blue or black coin inserts.

Format: 310 x 255 x 82 mm

**NERA Case XL**

**Includes 3 trays**

🛒 2365-... (+ with insert of your choice\*)

Incl.  
3 trays  
of your  
choice!

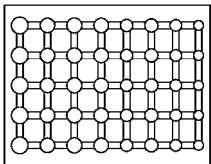
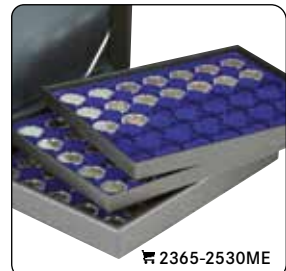

5x €-coin set in LINDNER coin capsules

- ...-2556E
- ...-2956E
- ...-2556ME
- ...-2556CE

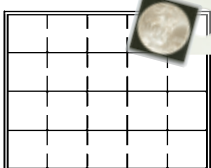

50 x 50 mm 20x

- ...-2122E
- ...-2722E
- ...-2122ME
- ...-2122CE

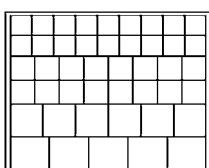

24, 28, 39, 44 mm

- ...-2145E
- ...-2745E
- ...-2145ME
- ...-2145CE

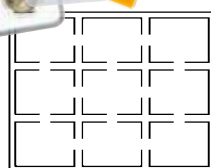

Ø 63 x 85 mm Slabs 9x

- ...-2219E
- ...-2619E
- ...-2219ME

- Velour insert red
- Velour insert dark red
- Velour insert dark blue
- Velour insert black

# SOLID WOOD CASE CARUS-1

## SOLID WOOD CASE CARUS-1 WITH ONE VELOUR COIN INSERT

Solid wood case in a perfect, dark finish surface. The surface is smooth and shows the natural grain of the wood. The natural grain of the wood on the outside of the lid as well as the inner side enhances each case giving it an individual character. The appearance of each case is enhanced by the stable

LINDNER-latch. The inserts are covered in high-quality dark red or dark blue velour.

Format: 303 x 240 x 30 mm



CARUS-1  
€ 43.50

Made in Germany

Available with blue inserts/trays too.



PEFC certified  
This case comes from sustainably managed forests and controlled sources.  
[www.pefc.org](http://www.pefc.org)

24 x 24 mm 80x	30 x 30 mm 48x	36 x 36 mm 35x	38 x 38 mm 30x	42 x 42 mm 24x	47 x 47 mm 20x
● S2491-2780E ● S2491-2180ME	● S2491-2748E ● S2491-2148ME	● S2491-2735E ● S2491-2135ME	● S2491-2715E ● S2491-2115ME	● S2491-2724E ● S2491-2124ME	● S2491-2720E ● S2491-2120ME
50 x 50 mm 20x	6x €-coin set	∅ 25.75 mm 54x	∅ 32 mm 35x	∅ 32.5 mm 35x	∅ 37.5 mm 30x
● S2491-2722E ● S2491-2122ME	● S2491-2906E ● S2491-2506ME	● S2491-2754E ● S2491-2154ME	● S2491-2930E ● S2491-2530ME	● S2491-2711E ● S2491-2111ME	● S2491-2937E ● S2491-2537ME
∅ 63 x 85 mm Slabs 9x					
● S2491-2619E ● S2491-2219ME					



For thicker coins/coin capsules from a height of 6,5 mm, we recommend collecting in coin cases with d-box inserts (see page 31) or in LINDNER d-boxes (see page 10).

# SOLID WOOD CASE CARUS-4

COMPACT CASE WITH LOTS OF SPACE – PURE WOOD CASE WITH 4 TRAYS AND VELOUR COIN INSERTS.

Pure wood – for LINDNER this means: authentic wood in a perfect, dark stained finish. The surface is very smooth and shows the natural grain of the wood. The wood trays inside have two indentations – one on each side – to remove or fill the trays more easily. Two durable latches are not only functional

but also enhance the appearance of the coin case. The coin inserts are covered in high-quality dark red or dark blue velour.

Format: 325 x 265 x 65 mm

All cases one price!

Available with blue inserts/trays too.

With 4 different coin trays:  
ASSORTEMENT:

- 47 x 47 mm 20x
- 42 x 42 mm 24x
- 36 x 36 mm 35x
- 30 x 30 mm 48x

- 2494-1
- 2494-1M



Made in Germany



CARUS-4

€ 95.50



PEFC certified

This case comes from sustainably managed forests and controlled sources.

www.pefc.org

With 4 identical coin trays:

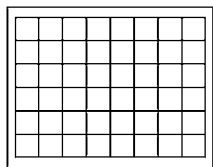

30 x 30 mm 192x

- 2494-6
- 2494-6M

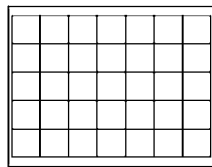

36 x 36 mm 140x

- 2494-5
- 2494-5M

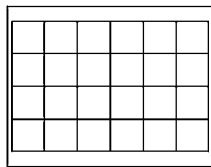

42 x 42 mm 96x

- 2494-4
- 2494-4M

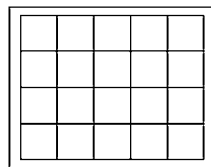

47 x 47 mm 80x

- 2494-2
- 2494-2M

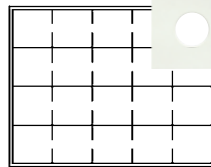

50 x 50 mm 80x

- 2494-3
- 2494-3M

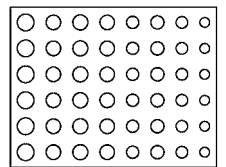

24x €-coin set

- 2494-12
- 2494-12M

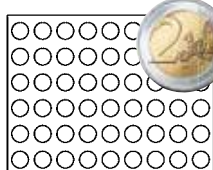

Ø 25.75 mm 216x

- 2494-10
- 2494-10M

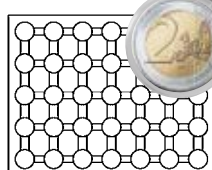

Ø 32.0 mm 140x

- 2494-11
- 2494-11M

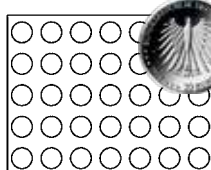

Ø 32.5 mm 140x

- 2494-7
- 2494-7M

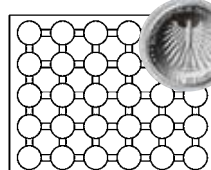

Ø 37.0 mm 120x

- 2494-9
- 2494-9M

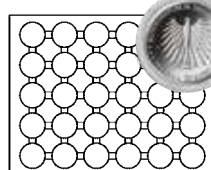

39.0 mm 120x

- 2494-8
- 2494-8M

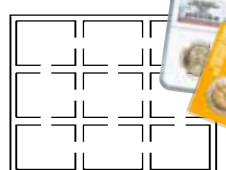

Ø 63 x 85 mm

Slabs 36x

- 2494-19
- 2494-19M

# SOLID WOOD COIN CASE

## WITH 5 BLACK OR DARK BLUE INSERTS

Solid wood case in a perfect, dark finish surface. The surface is smooth and shows the natural grain of the wood. The natural grain of the wood on the outside of the lid as well as the inner side enhances each case giving it an individual character. The appearance of each coin case is enhanced by the stable LINDNER-latch. The coin inserts are covered in high-quality black or dark blue velour.

Format: 305 x 245 x 55 mm

EACH CASE

€ 69.50

Made in Germany



PEFC certified

This case comes from sustainably managed forests and controlled sources.

[www.pefc.org](http://www.pefc.org)

With 5 identical coin trays:

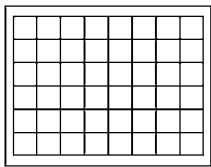

**30 x 30 mm** 240x  
● S2495-S2148CE  
● S2495-S2148ME

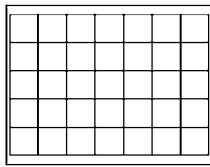

**36 x 36 mm** 175x  
● S2495-S2135CE  
● S2495-S2135ME

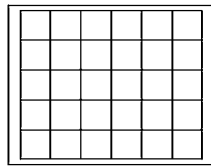

**38 x 38 mm** 150x  
● S2495-S2115CE  
● S2495-S2115ME

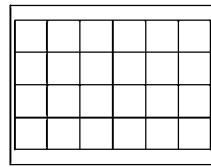

**42 x 42 mm** 120x  
● S2495-S2124CE  
● S2495-S2124ME

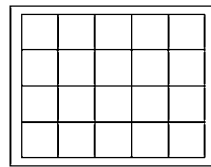

**47 x 47 mm** 100x  
● S2495-S2120CE  
● S2495-S2120ME

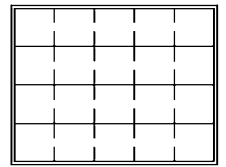

**50 x 50 mm** 100x  
● S2495-S2122CE  
● S2495-S2122ME

# PRESENTATION CASE ALU

Store your coins in a modern design. Case in noble aluminium design with black padded lining of the lid and black coin insert with square compartments.

The coin insert is covered with high-quality velour.

Format: 300 x 245 x 33 mm

EACH CASE

€ 39.50

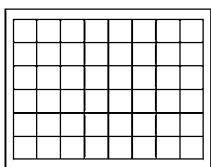

**30 x 30 mm** 48x  
● S2301-2148CE

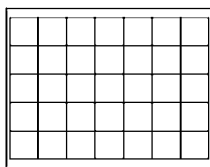

**36 x 36 mm** 35x  
● S2301-2135CE

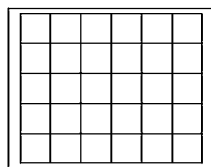

**38 x 38 mm** 30x  
● S2301-2115CE

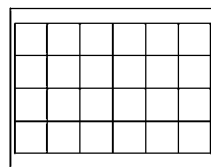

**42 x 42 mm** 24x  
● S2301-2124CE

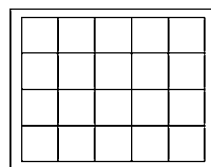

**47 x 47 mm** 20x  
● S2301-2120CE

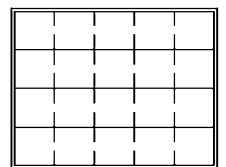

**50 x 50 mm** 20x  
● S2301-2122CE

# SOLID WOOD CASE CARUS-1

Solid wood case in a perfect, dark finish surface. The surface is smooth and shows the natural grain of the wood. The natural grain of the wood on the outside of the lid as well as the inner side enhances each case giving it an individual character. The appearance of each case is enhanced by the stable LINDNER-latch. The inserts are covered in high-quality velour.

**Format: 303 x 240 x 30 mm**  
**Max. filling height: 18,5 mm**  
 For larger and thicker coins/medals or other collectibles.



CARUS-1  
**€ 43.50**

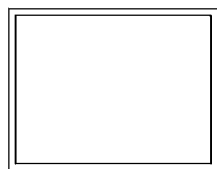

210 x 270 mm 1x

- S2491-2800E
- S2491-2850E

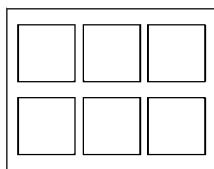

85 x 85 mm 6x

- S2491-2806E
- S2491-2856E

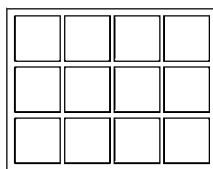

66 x 66 mm 12x

- S2491-2812E
- S2491-2862E

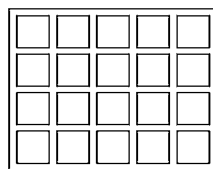

47 x 47 mm 20x

- S2491-2820E
- S2491-2870E



PEFC certified  
 This case comes from sustainably managed forests and controlled sources.  
[www.pefc.org](http://www.pefc.org)

# NERA CASE M PLUS - WITH WINDOW

Timeless elegance, a clear design, versatility, functionality and most of all, a special touch – these are the magnificent features of our NERA series. Coin case with black, grained surface in leather optic and creme coloured stitching with window. The coin trays are covered with a high quality velour-like surface.

**Format: 298 x 243 x 35 mm**  
**Max. filling height: 18,5 mm**  
 For larger and thicker coins/medals or other collectibles.



NERA M PLUS  
**€ 51.50**

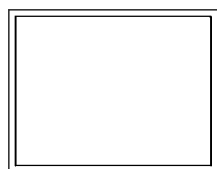

210 x 270 mm 1x

- 2367-2800E
- 2367-2850E

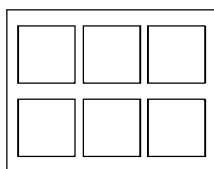

85 x 85 mm 6x

- 2367-2806E
- 2367-2856E

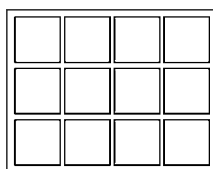

66 x 66 mm 12x

- 2367-2812E
- 2367-2862E

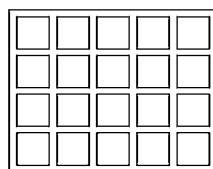

47 x 47 mm 20x

- 2367-2820E
- 2367-2870E

For more products of the NERA series, see from page 24.

# KARAT-COIN ALBUMS



Karat

Made in Germany

## COIN ALBUM KARAT CLASSIC

For an attractive presentation, practical handling and safe storage of your coins. For many years collectors continue to choose the advantages of our karat-coin system.

High-quality padded ring binder made of padded synthetic foil. Equipped with 10 karat-coin pages (3x K2, 2x K3, 1x K4, 1x K5, 2x K6, 1x K8) and 10 red interleaves.

You can choose from two kinds of slipcases:

- slipcase made of cardboard with matching coloured cover material (Order no. 810D or complete album Order no. 1106E)
- slipcase made of synthetic with cut outs for easily removing of the ring binder (Order no. 810K or complete album Order no. 1106EK).

**Format:** 225 x 210 x 35 mm

**Mechanism:** 4-ring, 45/65/45 mm

**Capacity:** approx. 10 karat-coin pages

€ 44.50	€ 62.50	€ 58.50	€ 28.00	€ 25.00	€ 20.50

# KARAT-COIN PAGES

Karat

The pages are easy to use and keep your coins safely in place. Simply remove the plastic strip from the page and insert the coins in the individual compartments. Once it is filled, insert the strip back into the page - that's it! The pages are easily removed, added or changed.

**Material:** Hard-PVC-foil (Insert strips)

**Format:** 188 x 210 mm

**Scope of Delivery:** 5 coin pages incl. interleaving pages

 Ø 22 mm 48x Pack of 5 Interleaving white € K6W € 12.50 Interleaving red € K6R € 12.50	 Ø 30 mm 30x Pack of 5 Interleaving white € K4W € 12.50 Interleaving red € K4R € 12.50	 Ø 38 mm 20x Pack of 5 Interleaving white € K3W € 12.50 Interleaving red € K3R € 12.50	 Ø 38/30/22 mm 33x Pack of 5 Interleaving white € K5W € 12.50 Interleaving red € K5R € 12.50	 Ø 48 mm 12x Pack of 5 Interleaving white € K2W € 12.50 Interleaving red € K2R € 12.50
 Ø 65 mm 6x Pack of 5 Interleaving white € K1W € 12.50 Interleaving red € K1R € 12.50	 Coin page incl. illustrated Euro coin set page suited for: 3 complete sets of € coins Pack of 5 € K8E € 12.50	 50 x 50 mm 9x Pack of 5 Interleaving white € K9W € 9.50 Interleaving red € K9R € 9.50	 Perforated colour flag-page for labeling the karat-coin page K8, with the flags of the Euro-Countries. Country names in three languages: German, English and French. € 15 € 7.50	 Perforated colour flag-page for labeling the karat-coin page K8 with the flags of the new Euro-Countries and the rest of the European countries. Country names in three languages: German, English and French. € 14 € 7.50

## RING BINDER KARAT LEATHER

High-quality manufacturing, padded ring binder made of real leather.

**Format:** 225 x 210 x 35 mm

**Mechanism:** 4-ring, 45/65/45 mm

**Capacity:** approx. 10 karat-coin pages

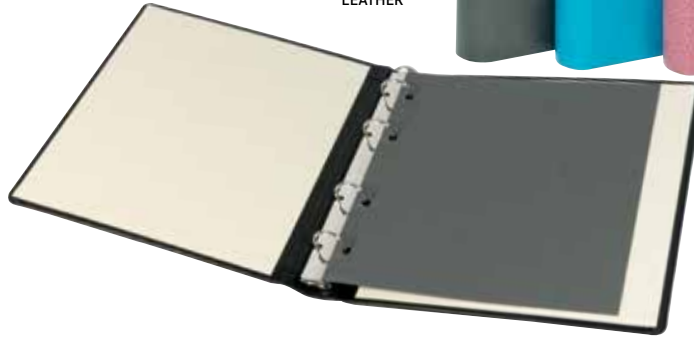

Suitable karat-coin pages can be found on page 32.

karat



- 🛒 1106L-G
  - 🛒 1106L-S
  - 🛒 1106L-B
  - 🛒 1106L-H
  - 🛒 1106L-W
- € 57.50



karat

## COIN ALBUM PUBLICA S

### INCLUDING 5 COIN PAGES IN DIFFERENT SIZES

Padded ring binder PUBLICA S made of padded synthetic foil. The grained surface gives this ring binder its individual character. The spacious window on the spine offers space for listing of the content.

Comes with 5 karat-coin pages (K2, K3, K4, K5, K8) and 5 red interleaving pages.

**Format:** 225 x 240 x 60 mm

**Mechanism:** 4-ring, 45/65/45 mm

**Capacity:** approx. 25 coin pages depending on the size of the coins



🛒 S3520M  
€ 37.50



🛒 3520  
€ 26.50

## KARAT BASIC COIN ALBUM

Album consists of ring binder in modern design including the matching slipcase and 5 karat-coin pages (K2, K3, K4, K5 and K8).

**Material:** Cardboard ring binder, covered

**Format:** 240 x 230 x 55 mm

**Mechanism:** 4-ring, 45/65/45 mm

**Capacity:** approx. 25 coin pages depending on the size of the coins

karat

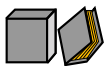

🛒 1116M  
€ 31.50

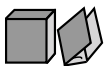

🛒 1116  
€ 26.50



## KARAT ILLUSTRATED RING BINDER COIN-DESIGN, EMPTY

Padded karat-ring binder made of synthetic foil in coin-design.  
Suitable for all LINDNER karat-coin pages.

**Material Ring binder:** Synthetic-foil, padded

**Scope of Delivery:** Ring binder, empty

**Format:** 210 x 230 x 35 mm

**Mechanism:** 4-ring, 45/65/45 mm



**Capacity:** approx. 10 karat-coin pages  
incl. interleaving pages

KARAT 

Made  
in  
Germany

🛒 1115R

€ 28.50

	
🛒 1115R	🛒 810D-S
€ 28.50	€ 20.50

Suitable karat-coin pages can  
be found on page 32.

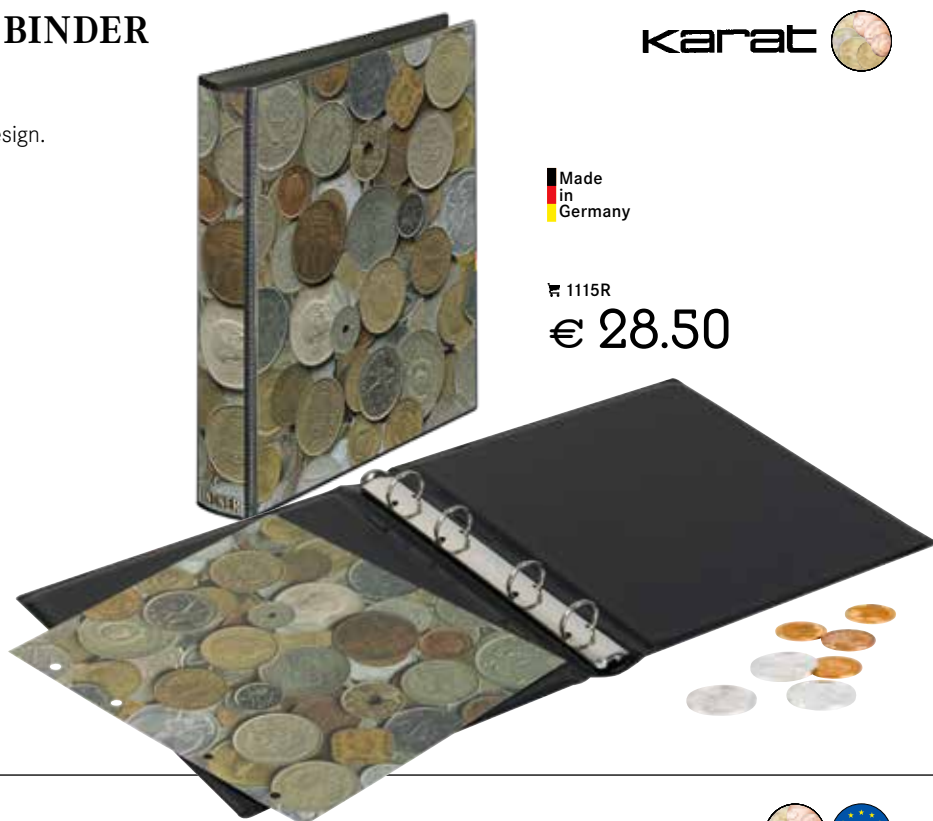

## ILLUSTRATED ALBUM EURO COLLECTION

Illustrated album for coin sets of all Euro-countries  
(without Andorra, Monaco, San Marino, Vatican).

This album comes with 7 coloured illustrated  
pages and 7 coin pages with hard-PVC-inserts.  
Every single page allows space for the current  
coin sets of three different countries. One set of  
coins per country can be stored on this page.

**Scope of Delivery:** Ring binder, 7 Euro-Collection  
coin pages, 7 illustrated pages in colour,  
(Order no. 8450-1 until 8450-42, see table on the  
right), slipcase.

**Format Ring binder:** 250 x 270 x 60 mm

**Mechanism:** 4-ring, 45/65/45 mm

**Capacity:** approx. 15 coin pages

**Single pages** (Format: 200 x 250 mm)

All pages of this basic edition are also available  
separately.

🛒	Illustrated page incl. coin page	€ 6.50
8450-1	Belgium/Germany/Finland	
8450-4	France/Greece/Ireland	
8450-7	Italy/Luxembourg/Netherlands	
8450-10	Austria/Portugal/Spain	
8450-36	Slovenia/Malta/Cyprus	
8450-39	Slovakia/Estonia/Latvia	
8450-42	Lithuania/Croatia/Bulgaria	
8450-13*	Monaco/San Marino/Vatican	
8450-0*	Neutral additional page without coin pictures	

**Single pages with commentary**

For this album we also offer illustrated pages for  
the new Euro countries with interesting informati-  
on about the new coins and the country. In con-  
trast to the basic edition we offer here one page  
per country.

🛒	Illustrated page incl. coin page	€ 6.50
8450-16	3 Coin sets Slovenia	
8450-17	3 Coin sets Malta	
8450-18	3 Coin sets Cyprus	
8450-19	3 Coin sets Slovakia	
8450-20	3 Coin sets Estonia	
8450-21	3 Coin sets Latvia	
8450-22	3 Coin sets Lithuania	
8450-23	3 Coin sets Croatia	
8450-24	3 Coin sets Bulgaria	

	
🛒 8450	🛒 8450L
€ 48.00	€ 30.00

Made  
in  
EU



### General indications

- ▶ If needed all illustrated albums will be completed or extended. New and updated pages are available separately.

## ILLUSTRATED COIN ALBUM FOR EURO COIN SETS

Illustrated album basic edition: Illustrated album for the current coin sets of all Euro countries (without Andorra, Monaco, San Marino and Vatican).

This album includes 7 coloured pages with illustrations of the current €-coin sets of the Euro countries, as well as 7 karat-coin pages with hard-PVC-inserts. Every single page allows space for the current coin sets of three different countries. One set of coins per country can be stored on this page.

**Material Ring binder:** Synthetic-foil, padded

**Scope of Delivery:** Ring binder, 7 karat-coin pages K8, 7 illustrated pages (Order no. 1108-1 until 1108-22, see table below).

**Format:** 210 x 230 x 35 mm

**Mechanism:** 4-ring, 45/65/45 mm

**Capacity:** approx. 10 coin pages

1608M	1608R	810D-S
€ 49.50	€ 28.50	€ 20.50



Made in Germany

1608M  
€ 49.50

incl. Bulgaria 2026



## ILLUSTRATED COIN ALBUM FOR EURO COIN SETS

Illustrated album basic edition: Illustrated album for the current coin sets of all Euro countries (without Andorra, Monaco, San Marino and Vatican).

This album includes 7 coloured pages with illustrations of the current €-coin sets of the Euro countries, as well as 7 karat-coin pages with hard-PVC-inserts. Every single page allows space for the current coin sets of three different countries. One set of coins per country can be stored on this page.

**Material Ring binder:** Laminated cardboard

**Scope of Delivery:** Ring binder, 7 karat-coin pages K8, 7 illustrated pages (Order no. 1108-1 until 1108-22).

**Format Ring binder:** 230 x 240 x 55 mm

**Mechanism:** 4-ring, 45/65/45 mm

**Capacity:** approx. 15 coin pages



Made in Germany

1108M	1108E	1109	1108K
€ 37.00	€ 43.50	€ 19.00	€ 19.50

incl. Bulgaria 2026

### Single pages (Format: 188 x 210 mm)

All pages of this basic edition are also available separately.

1608M	Illustrated page incl. karat-coin page K8	€ 6.00
1108-1	Belgium/Netherlands/Luxembourg	
1108-2	Germany/Austria/France	
1108-3	Finland/Ireland/Greece	
1108-7	Italy/Spain/Portugal	
1108-16	Slovenia/Malta/Cyprus	
1108-19	Slovakia/Estonia/Latvia	
1108-22	Lithuania/Croatia/Bulgaria	
1108-13*	Monaco/San Marino/Vatican	

### Single pages with commentary

For this album we offer also illustrated pages for the new Euro countries with interesting information about the new coins and the country. In contrast to the basic edition we offer here one page per country.

1608M	Illustrated page incl. karat-coin page K8	€ 6.00
1109-16	Slovenia	
1109-17	Malta	
1109-18	Cyprus	
1109-19	Slovakia	
1109-20	Estonia	
1109-21	Latvia	
1109-22	Lithuania	
1109-23	Croatia	
1109-24	Bulgaria	
1109-50	Change of ruler Netherlands	
1109-51	Change of ruler Belgium	
1109-52	Change of ruler Spain	

### General indications

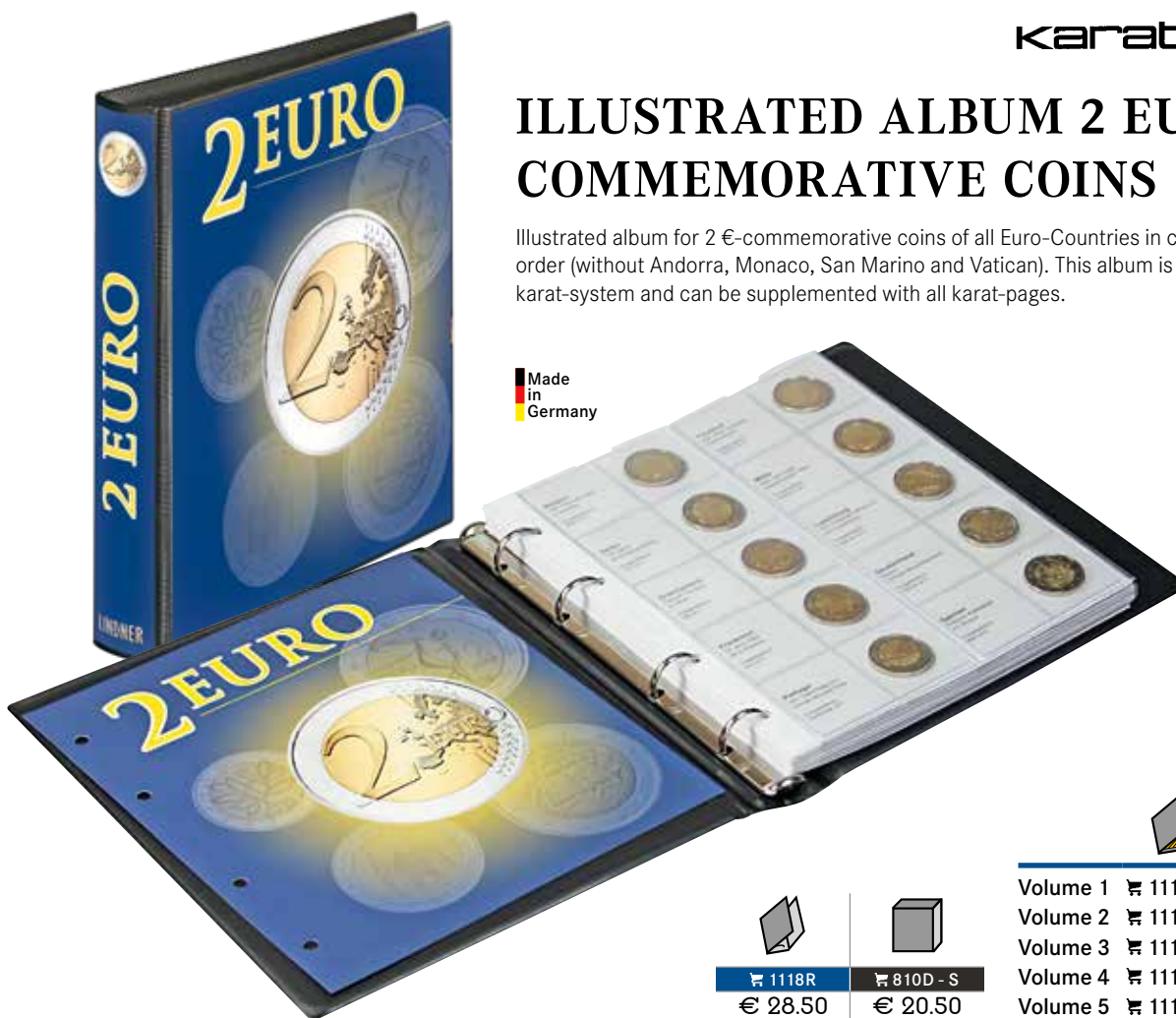

- ▶ If needed all illustrated albums will be completed or extended. New and updated pages are available separately.



# ILLUSTRATED ALBUM 2 EURO COMMEMORATIVE COINS

Illustrated album for 2 €-commemorative coins of all Euro-Countries in chronological order (without Andorra, Monaco, San Marino and Vatican). This album is based on our karat-system and can be supplemented with all karat-pages.

Made in Germany

	
1118R	810D - S
€ 28.50	€ 20.50

Volume 1	1118M	€ 55.50
Volume 2	1118M2	€ 55.50
Volume 3	1118M3	€ 55.50
Volume 4	1118M4	€ 55.50
Volume 5	1118M5	€ 53.50

**Material Ring binder:**

Synthetic-foil, padded

**Format Ring binder:** 210 x 230 x 35 mm

**Mechanism:** 4-ring, 45/65/45 mm

**Capacity:**

approx. 10 coin pages

**Volume 1** 1118M € 55.50

**Greece 2004 until Spain 2012**

**Scope of Delivery:** Ring binder, 9 karat-coin pages K3, 9 illustrated pages (Order no. 1118-1 until 1118-9).

**Volume 2** 1118M2 € 55.50

**Belgium 2012 until Finland 2016**

**Scope of Delivery:** Ring binder, 9 karat-coin pages K3, 9 illustrated pages (Order no. 1118-10 until 1118-18).

**Volume 3** 1118M3 € 55.50

**Lithuania 2016 until Malta 2019**

**Scope of Delivery:** Ring binder, 9 karat-coin pages K3, 9 illustrated pages (Order no. 1118-19 until 1118-27).

**Volume 4** 1118M4 € 55.50

**Latvia 2019 until Germany 2023**

**Scope of Delivery:** Ring binder, 9 karat-coin pages K3, 9 illustrated pages (Order no. 1118-28 until 1118-36).

**Volume 5** 1118M5 € 53.50

**Slovakia 2023 until Slovenia 2025**

**Scope of Delivery:** Ring binder, 8 karat-coin pages K3, 8 illustrated pages (Order no. 1118-37 until 1118-44).

**Single pages** (Format: 188 x 210 mm)

All pages of this basic edition are also available separately.

	Illustrated page incl. karat-coin page K3	€ 6.00		Illustrated page incl. karat-coin page K3	€ 6.00
Volume 1	1118-1	Greece 2004 - Italy 2005	Volume 3	1118-19	Lithuania 2016 - France 2016
	1118-2	Italy 2006 - Germany 2008		1118-20	Malta 2016 - Spain 2017
	1118-3	Common Issue "Treaty of Rome"		1118-21	France 2017 - Lithuania 2017
	1118-4	Luxemburg 2008 - Portugal 2009		1118-22	France 2017 - Luxembourg 2017
	1118-5	Common Issue "10 years Economic and Monetary Union"		1118-23	Italy 2017 - Spain 2018
	1118-6	Belgium 2009 - France 2010		1118-24	Spain 2018 - Portugal 2018
	1118-7	Italy 2010 - Slovenia 2011		1118-25	Italy 2018 - Luxembourg 2018
	1118-8	Common Issue "10 years €"		1118-26	Germany 2019 - France 2019
	1118-9	Belgium 2011 - Spain 2012		1118-27	Luxembourg 2019 - Malta 2019
Volume 2	1118-10	Belgium 2012 - Germany 2013	Volume 4	1118-28	Latvia 2019 - France 2020
	1118-11	Slovenia 2013 - Greece 2013		1118-29	Luxembourg 2020 - Portugal 2020
	1118-12	Greece 2013 - Portugal 2014		1118-30	Portugal 2020 - Slovenia 2020
	1118-13	Slovakia 2014 - Greece 2014		1118-31	Cyprus 2020 - Lithuania 2021
	1118-14	Greece 2014 - Germany 2015		1118-32	Portugal 2021 - Latvia 2021
	1118-15	Common Issue "30 years European Flag"		1118-33	Belgium 2021 - Estonia 2022
	1118-16	Germany 2015 - France 2015		1118-34	Spain 2022 - Luxembourg 2022
	1118-17	Italy 2015 - Lithuania 2015		1118-35	Common Issue "35 years Erasmus-Program"
	1118-18	Greece 2016 - Finland 2016		1118-36	Greece 2022 - Germany 2023
Band 5	1118-37	Slovakia 2023 - Italy 2023	Band 5	1118-37	Slovakia 2023 - Italy 2023
	1118-38	Latvia 2023 - Croatia 2023		1118-38	Latvia 2023 - Croatia 2023
	1118-39	Cyprus 2023 - France 2024		1118-39	Cyprus 2023 - France 2024
	1118-40	Malta 2023 - Estonia 2024		1118-40	Malta 2023 - Estonia 2024
	1118-41	Belgium 2024 - Croatia 2024		1118-41	Belgium 2024 - Croatia 2024
	1118-42	Latvia 2024 - Lithuania 2025		1118-42	Latvia 2024 - Lithuania 2025
	1118-43	Malta 2024 - Belgium 2025		1118-43	Malta 2024 - Belgium 2025
	1118-44	Finland 2025 - Slovenia 2025		1118-44	Finland 2025 - Slovenia 2025

**General indications**

- ▶ If needed all illustrated albums will be completed or extended. New and updated pages are available separately.

## ILLUSTRATED ALBUM 2 EURO COMMEMORATIVE COINS: SERIES "GERMAN FEDERAL STATES"



Illustrated album basic edition: From 2023 to 2038, each German federal state will issue its own 2 €-commemorative coin. On the illustrated pages, the coins are shown with all 5 mint letters.

**Scope of Delivery:** Ring binder, 4 karat-coin pages K3, 4 illustrated pages (Order no. 1114-1 until 1114-4).

**Material Ring binder:**

Synthetic-foil, padded

**Format Ring binder:** 210 x 230 x 35 mm

**Mechanism:** 4-ring, 45/65/45 mm

**Capacity:** approx. 10 coin pages

**Single pages** (Format: 188 x 210 mm)

All pages of this basic edition are also available separately.

🛒	Illustrated page incl. karat-coin page K3	€ 6.00
1114-1	2023 Hamburg / Elbphilharmonie	
1114-2	2024 Mecklenburg-Vorpommern / Königsstuhl	
1114-3	2025 Saarland / Saarschleife	
1114-4	2026 Bremen / Klimahaus Bremerhaven	

Made in Germany

🛒 1114M	🛒 1114R	🛒 810D - S
€ 39.00	€ 28.50	€ 20.50



### General indications

- ▶ If needed all illustrated albums will be completed or extended. New and updated pages are available separately.

## ILLUSTRATED ALBUM 5 EURO COLLECTOR COINS: GERMANY



Illustrated album edition based on our karat-system with colourful coin illustrations for chronological storage of 5 €-collector coins Germany (all 5 mints).

**Scope of Delivery:** Ring binder, 4 karat-coin pages K3, 4 illustrated pages (Order no. 1119-1 until 1119-4).

**Material Ring binder:**

Synthetic-foil, padded

**Format Ring binder:** 210 x 230 x 35 mm

**Mechanism:** 4-ring, 45/65/45 mm

**Capacity:** approx. 10 coin pages

**Single pages** (Format: 188 x 210 mm)

All pages of this basic edition are also available separately.

🛒	Illustrated page incl. karat-coin page K3	€ 6.00
1119-1	Germany 2016 (Planet Erde) - 2017 (Tropische Zone)	
1119-2	Germany 2018 (Subtropische Zone) - 2019 (Gemäßigte Zone)	
1119-3	Germany 2020 (Subpolare Zone) - 2021 (Polare Zone)	
1119-4	Germany 2022-2024 (Wunderwelt Insekten)	

Made in Germany

🛒 1119M	🛒 1119R	🛒 810D - S
€ 39.00	€ 28.50	€ 20.50



### General indications

- ▶ If needed all illustrated albums will be completed or extended. New and updated pages are available separately.

## ILLUSTRATED ALBUM 10 EURO COLLECTOR COINS WITH POLYMER RING: GERMANY



Illustrated album edition based on our karat-system with colourful coin illustrations for chronological storage of 10 €-collector coins Germany with polymer ring (all 5 mints).

**Scope of Delivery:** Ring binder, 8 karat-coin pages K3, 8 illustrated pages (Order no. 1110-1 until 1110-8).

**Material Ring binder:** Synthetic-foil, padded

**Format Ring binder:** 210 x 230 x 35 mm

**Mechanism:** 4-ring, 45/65/45 mm

**Capacity:** approx. 10 coin pages

**Single pages** (Format: 188 x 210 mm)

All pages of this basic edition are also available separately.

#	Illustrated page incl. karat-coin page K3	€ 6.00
1110-1	Germany 2019 (In der Luft)	
1110-2	Germany 2020 (An Land)	
1110-3	Germany 2021 (Auf dem Wasser)	
1110-4	Germany 2022 (Pflege)	
1110-5	Germany 2023 (Feuerwehr)	
1110-6	Germany 2024 (Polizei)	
1110-7	Germany 2025 (Technisches Hilfswerk)	
1110-8	Germany 2026 (Rettungsdienste)	

Made in Germany

1110M	1110R	810D-S
€ 53.50	€ 28.50	€ 20.50

### General indications

- ▶ If needed all illustrated albums will be completed or extended. New and updated pages are available separately.



## ILLUSTRATED ALBUM 20 EURO SILVER COINS: GERMANY



Illustrated album basic edition based on our karat-system with coin illustrations for chronological storage of 20 €-Silver coins of Germany 2016-2025.

**Scope of Delivery:** Ring binder, 10 karat-coin pages K2, 10 illustrated pages (Order no. 1520-16 until 1520-25).

**Material Ring binder:** Synthetic-foil, padded

**Format Ring binder:** 210 x 230 x 35 mm

**Mechanism:** 4-ring, 45/65/45 mm

**Capacity:** approx. 10 coin pages

**Single pages** (Format: 188 x 210 mm)

All pages of this basic edition are also available separately.

#	Illustrated page incl. karat-coin page K2	€ 6.00
1520-16	Germany 2016	
1520-17	Germany 2017	
1520-18	Germany 2018	
1520-19	Germany 2019	
1520-20	Germany 2020	
1520-21	Germany 2021	
1520-22	Germany 2022	
1520-23	Germany 2023	
1520-24	Germany 2024	
1520-25	Germany 2025	

1520	1520R	810D-S
€ 55.50	€ 28.50	€ 20.50

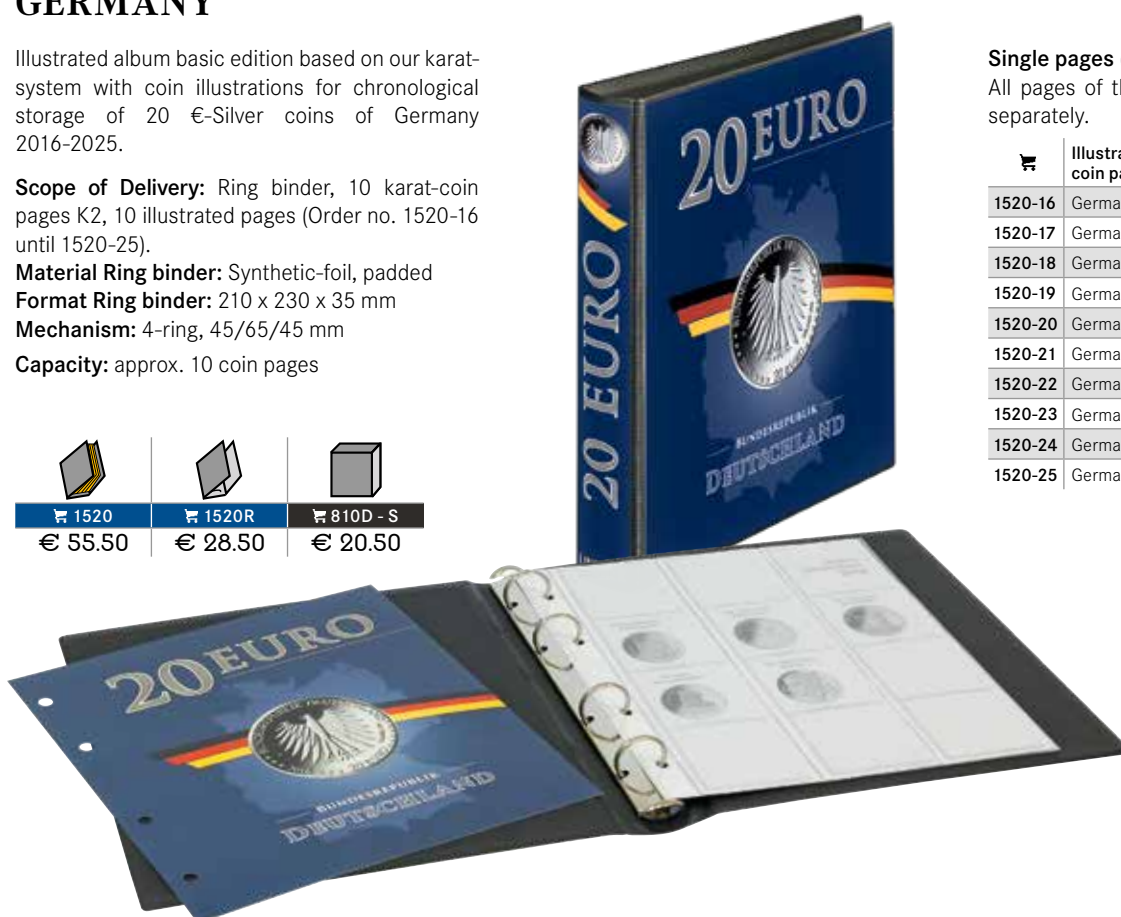

CONTINUE COLLECTING IN THE 35 EURO ALBUM P. 39

Made in Germany

## ILLUSTRATED ALBUM 35 EURO SILVER COINS: GERMANY



Illustrated album to continue the 20 Euro album based on our karat system with coin illustrations for chronological storage of Germany from 2026 onwards.

**Scope of Delivery:** Ring binder, 1 karat-coin page K2, 1 illustrated page (Order no. 1535-26).

**Material Ring binder:**

Synthetic-foil, padded

**Format Ring binder:** 210 x 230 x 35 mm

**Mechanism:** 4-ring, 45/65/45 mm

**Capacity:** approx. 10 coin pages

**Single pages** (Format: 188 x 210 mm)

All pages of this basic edition are also available separately.

🛒 1535-26	Illustrated page incl. karat-coin page K2 Germany 2026	€ 6.00
-----------	---	--------



🛒 1535	🛒 1535R	🛒 810D - S
€ 31.00	€ 28.50	€ 20.50

**General indications**

- ▶ If needed all illustrated albums will be completed or extended. New and updated pages are available separately.



Made in Germany

## KARAT-ALBUM FOR PRESSED PENNIES



Padded karat-ring binder made of synthetic material in "Pressed Penny"-Design with 2 karat-pages and white interleaving pages.

**Scope of Delivery:** Ring binder and 2 karat-coin pages K3W.

**Material Ring binder:**

Padded karat-ring binder made of synthetic material in "Pressed Penny"-Design.

**Format Ring binder:** 210 x 230 x 35 mm

**Mechanism:** 4-ring, 45/65/45 mm

**Capacity:** approx. 10 coin pages

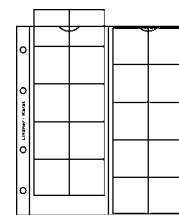

○ K3W

Coin pages available separately per pack of 5 (Order no. K3W). € 12.50

**Other ways to collect Pressed Pennies:**  
Pocket Album for coins see page 49.  
HARTBERGER® Coin holders see page 14-15.



Made in Germany

🛒 1136	🛒 1136R	🛒 810D - S
€ 33.50	€ 28.50	€ 20.50

# MULTI COLLECT - SYSTEM

## VERSATILE COLLECTING WITH OUR MULTI-TALENTED SYSTEM

Versatile collecting with our multi-purpose album system. This album rightly deserves its name – every collector can find a large assortment of pages with a wide variety of pocket sizes which provides different types of collections.

Whether you collect stamps, sheetlets, FDCs, ETBs, year books, booklets, postcards, banknotes, coins or phone cards: Our Multi collect-system has a place for everything! The typical 4-ring mechanism of the padded Multi collect-ring binder guarantees easy handling and impresses with a large capacity. A plastic window on the spine provides space for identification labels/description of contents.

We offer ring binders which differ in size, colour and storage capacity.

Fitting ring binders are found on page 42-43.



1 pocket  
190 x 253 mm

Pack of 10

- MU1311 € 12.50
- MU1321 € 11.50

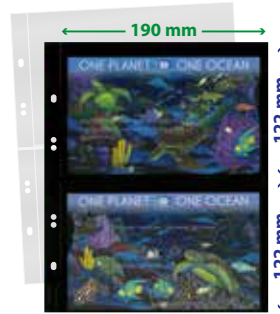

2 strips  
190 x 122 mm

Pack of 10

- MU1312 € 12.50
- MU1322 € 11.50

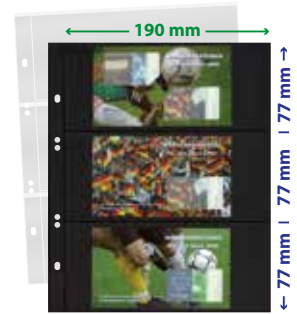

3 strips  
190 x 77 mm

Pack of 10

- MU1313 € 12.50
- MU1323 € 11.50

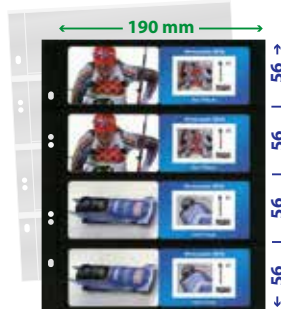

4 strips  
190 x 56 mm

Pack of 10

- MU1314 € 12.50
- MU1324 € 11.50



5 strips  
190 x 43 mm

Pack of 10

- MU1315 € 12.50
- MU1325 € 11.50

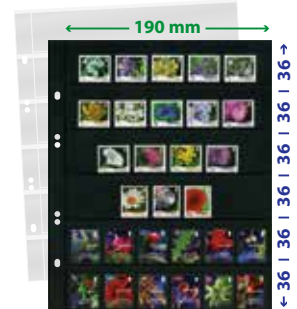

6 strips  
190 x 36 mm

Pack of 10

- MU1316 € 12.50
- MU1326 € 11.50



2 vertical strips  
91 x 253 mm

Pack of 10

- MU1317 € 12.50



1 pocket  
151 x 235 mm

Pack of 10

- MU1330 € 12.50
- MU1340 € 11.50

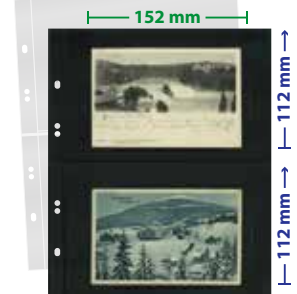

2 strips  
152 x 112 mm

Pack of 10

- MU1331 € 12.50
- MU1341 € 11.50

### BLANK PAGES

With 4-ring perforation  
Size PUBLICA M: 210 x 255 mm  
Material: 200 g/qm

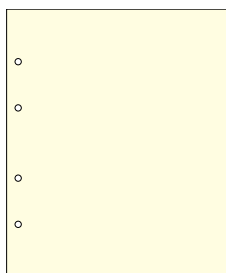

Blank pages  
210 x 255 mm

Pack of 10

- ☒ 803o € 12.50

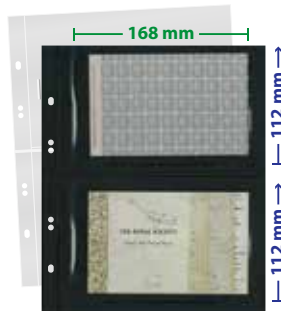

2 strips  
168 x 112 mm

Pack of 10

- MU1332 € 12.50
- MU1342 € 11.50

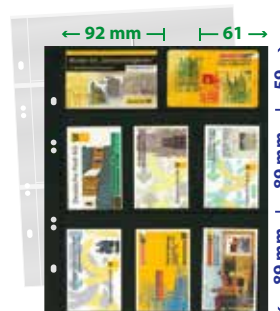

8 pockets  
92 x 59 mm (2x)  
61 x 89 mm (6x)

Pack of 10

- MU1353 € 12.50
- 1363\* 2) € 11.50

\*Delivery only while stocks last. 2) Suited for Ring binder ☒1300 and ☒1400

Prices do not include contents / display material. All prices and specifications are subject to change without prior notice.

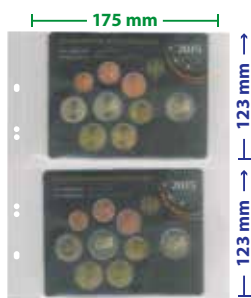

2 pockets  
175 x 123 mm  
2 sets Euro-coins Germany proof  
Pack of 10  
○ MU1363 € 11.50



8 pockets  
93 x 56 mm  
Coincards, Telephone cards  
Pack of 10  
○ MU1364 € 11.50



1 pocket  
180 x 207 mm  
current coin sets in blister  
Pack of 10  
○ MU1392 € 11.50

### MULTI COLLECT-PAGES

The **one-sided**, crystal clear Multi collect-pages are made of softener and acid-free hard-PVC-foil. You can view the front and back of the items that are placed in these pages.

The **double-sided**, black Multi collect-pages are made of archival safe hard-PVC, that is free of acids and chemical softeners to ensure long term preservation and presentation.

Format: 210 x 255 mm



1 pocket  
185 x 250 mm  
one pocket with black insert  
Pack of 10  
○ MU1405 € 12.50



2 pockets  
185 x 120 mm  
two pockets with black inserts  
Pack of 10  
○ MU1404 € 12.50



3 pockets  
185 x 80 mm  
three pockets with black inserts  
Pack of 10  
○ MU3103 € 12.50

### MULTI COLLECT-PAGES FOR BANKNOTES

The Multi collect-pages made of crystal-clear, softener and acid-free hard-PVC-foil with black foil insert strips can be filled twice. The foil insert strips are removable. This offers the possibility to fill the pockets with just one receipt and the front and back of the contents can be viewed.

Format: 210 x 255 mm



12 pockets Ø 50 mm  
Pack of 5  
Interleaving black  
● MU12<sup>3)</sup> € 12.50  
Interleaving red  
● MU12R<sup>3)</sup> € 12.50



15 pockets Ø 42 mm  
Pack of 5  
Interleaving black  
● MU15 € 12.50  
Interleaving red  
● MU15R € 12.50



24 pockets Ø 34 mm  
Pack of 5  
Interleaving black  
● MU24 € 12.50  
Interleaving red  
● MU24R € 12.50

### MULTI COLLECT-COIN PAGES

Our **crystal clear Multi collect-coin pages** provide neat and safe storage of your coin collection. Simply remove the plastic strip from the page and insert the coins in the individual compartments. Once it is filled, insert the strip back into the page. The pages are easily removed, added or changed.

Format: 202 x 252 mm

<sup>3)</sup> Made in EU

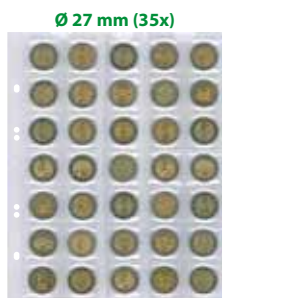

35 pockets Ø 27 mm  
Pack of 5  
Interleaving black  
● MU35 € 12.50  
Interleaving red  
● MU35R € 12.50



5x €-coin set  
Pack of 5  
Interleaving black  
● MU40 € 12.50  
Interleaving red  
● MU40R € 12.50

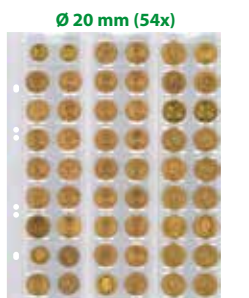

54 pockets Ø 20 mm  
Pack of 5  
Interleaving black  
● MU54 € 12.50  
Interleaving red  
● MU54R € 12.50

### INTERLEAVING PAGES

(Format: 210 x 255 mm)

- Interleaves are recommended for interleaving purposes
- Pack of 20, crystal clear  
○ MU1385 € 8.50
- Interleaving black  
Pack of 5  
● MUZ € 5.00
- Pack of 10  
● MU1386 € 8.50
- Interleaving red  
Pack of 5  
● MUZR € 5.00

# MULTI COLLECT-RING BINDER REGULAR CLASSIC

Padded ring binder made of padded synthetic-foil. The grained surface in leather-effect gives the ring binder its individual character. The typical 4-ring mechanism of the Multi collect-ring binder guarantees a simple handling and the ring binder impresses with its large capacity. The generous spine window offers space for content listing. Matching pages see page 40-41.

**Format Ring binder:** 245 x 270 x 80 mm

**Format Ring binder incl. Slipcase:** 250 x 280 x 85 mm

**Mechanism:** 4-ring, 40/80/40 mm



Made in Germany

**Capacity:**

approx. 20 Multi collect-coin pages

approx. 60 Multi collect-stockpages – black

approx. 80 Multi collect-stockpages – crystal clear

1302 - G	1300 - G	1301 - G
1302 - S	1300 - S	1301 - S
1302 - B	1300 - B	1301 - B
1302 - H	1300 - H	1301 - H
1302 - W	1300 - W	1301 - W
€ 51.00	€ 34.50	€ 26.00

# RING BINDER RONDO REGULAR COMPACT

Padded ring binder made of padded synthetic-foil. The rounded spine and grained surface gives the ring binder its classical look. The spine window offers space for content listing. Matching pages see page 40-41.

**Format Ring binder:** 235 x 270 x 40 mm

**Format Ring binder incl. Slipcase:** 245 x 280 x 45 mm

**Mechanism:** 4-ring, 40/80/40 mm



Made in Germany

1402 - G	1400 - G	1401 - G
1402 - S	1400 - S	1401 - S
1402 - B	1400 - B	1401 - B
1402 - H	1400 - H	1401 - H
1402 - W	1400 - W	1401 - W
€ 47.50	€ 31.00	€ 24.50

# COIN ALBUM HALF PENNY

Ring binder made of padded synthetic-foil, with Half Penny print on the cover. Comes with 10 Multi collect-coin pages (2x MU15R, 2x MU24R, 2x MU35R, 2x MU40R, 2x MU54R) and 10 red interleaves.

Matching pages see page 40-41.

**Format:** 235 x 270 x 40 mm

**Mechanism:** 4-ring, 45/65/45 mm

**Capacity:** approx. 12 coin pages

3107 - G	3109 - G
3107 - S	3109 - S
3107 - B	3109 - B
3107 - H	3109 - H
3107 - W	3109 - W
3107 - D	3109 - D
€ 47.00	€ 28.00



Made in Germany

# PUBLICA M



## COIN ALBUM WITH 10 COIN PAGES

PUBLICA M COLOR ring binder, equipped with 10 crystal clear Multi collect-pages in 5 variations (2 x MU15, 2 x MU24, 2 x MU35, 2 x MU40, 2 x MU54) for over 300 coins. The high-quality coin pages with transparent, softener-free slider inserts allow for a safe and practical storage of your coins. The characteristic slider insert system guarantees an especially practical functionality. You can easily remove, replace and exchange whole series. The coin pages are divided by black cardboard interleaves.

**Format Ring binder:** 245 x 270 x 60 mm

**Format Ring binder incl. Slipcase:** 250 x 280 x 75 mm

**Mechanism:** 4-ring, 45/65/45 mm

☞ S3542M - 1	☞ S3542 - 1
☞ S3542M - 9	☞ S3542 - 9
☞ S3542M - 5	☞ S3542 - 5
☞ S3542M - 4	☞ S3542 - 4
☞ S3542M - 13	☞ S3542 - 13
€ 49.50	€ 41.50

Made in Germany



Other products suitable for this ring binder can be found on pages 96.



Made in Germany



Other products suitable for this ring binder can be found on pages 95.

## PUBLICA M COIN ALBUM WITH 10 COIN PAGES

PUBLICA M ring binder comes with 10 transparent Multi collect-coin pages (2x MU15, 2x MU24, 2x MU35, 2x MU40, 2x MU54) to hold over 300 coins. Our crystal clear coin pages provide neat and safe storage of your coin collection. Simply remove the plastic strip from the page and insert the coins in the individual compartments. Once it is filled, insert the strip back into the page. The pages are easily removed, added, or changed. The coin pages are separated by black interleaving pages which provide a nice background for the coins.

**Format Ring binder:** 245 x 270 x 60 mm

**Format Ring binder incl. Slipcase:** 250 x 280 x 75 mm

**Mechanism:** 4-ring, 45/65/45 mm

☞ 3532M - G
☞ 3532M - S
☞ 3532M - B
☞ 3532M - H
☞ 3532M - W
€ 56.50



☞ 3515R
€ 33.00

## PUBLICA M RING BINDER COIN-DESIGN

Padded PUBLICA M-Ring binder made of padded synthetic-foil in coin-design. Suitable for all LINDNER Multi collect-coin pages with universal perforation. Matching pages see page 40-41.

**Format Ring binder:** 245 x 270 x 60 mm

**Mechanism:** 4-ring, 45/65/45 mm



Made in Germany

**PUBLICA M Capacity:**  
 approx. 15 Multi collect-coin pages  
 approx. 50 Multi collect-stockpages – black  
 approx. 70 Multi collect-stockpages – crystal clear



# PUBLICA M ILLUSTRATED ALBUM 2 EURO COINS

Illustrated album with coloured illustrations for all 2 €-commemorative coins of all Euro countries (without Andorra, Monaco, San Marino and Vatican) in chronological order. All “common issues” are also included.

Choose between album with slipcase and album without slipcase.

Made in Germany

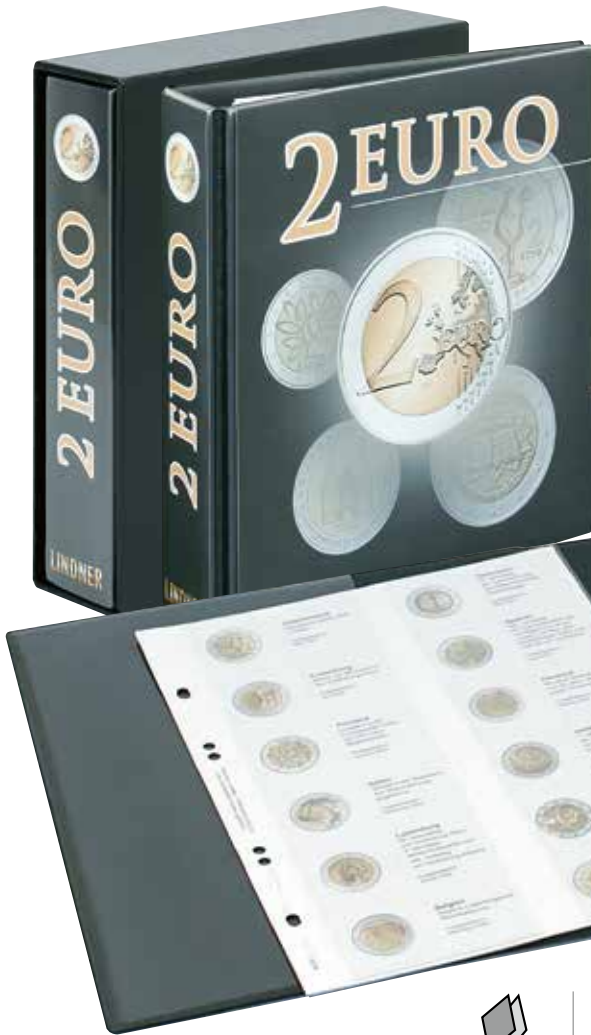

3535R	3531-S
€ 33.00	€ 21.00

Volume 1	3535M € 75.50	3535E € 86.50
Volume 2	3535M2 € 75.50	3535E2 € 86.50
Volume 3	3535M3 € 61.50	3535E3 € 73.50

**Material Ring binder:** Synthetic-foil, padded  
**Format Ring binder:** 270 x 245 x 60 mm  
**Mechanism:** 4-ring, 45/65/45 mm  
**Capacity:** approx. 15 coin pages

**Single pages** (Format: 210 x 255 mm)  
 All pages of this basic edition are also available separately.

**Volume 1**  
**Greece 2004 to France 2015**  
**Scope of Delivery:** Ring binder,  
 14 Multi collect coin pages MU24,  
 14 illustrated pages (MU2E1 - MU2E14).  
 3535M € 75.50  
 Set: Basic Edition + Slipcase  
 3535E € 86.50

**Volume 2**  
**Italy 2015 to Slovenia 2022**  
**Scope of Delivery:** Ring binder,  
 14 Multi collect coin pages MU24,  
 14 illustrated pages (MU2E15 - MU2E28).  
 3535M2 € 75.50  
 Set: Basic Edition + Slipcase  
 3535E2 € 86.50

**Volume 3**  
**Germany 2022 to Greece 2025**  
**Scope of Delivery:** Ring binder,  
 9 Multi collect coin pages MU24,  
 9 illustrated pages (MU2E29 - MU2E37).  
 3535M3 € 61.50  
 Set: Basic Edition + Slipcase  
 3535E3 € 73.50

	Illustrated page incl. Multi collect-coin page MU24	€ 6.50
Volume 1	MU2E1	Greece 2004 - Belgium 2006
	MU2E2	Luxemburg 2006 - France 2008
	MU2E3	Common Issue "Treaty of Rome"
	MU2E4	Portugal 2008 - Luxemburg 2010
	MU2E5	Common Issue "10 Years Economic and Monetary Union"
	MU2E6	Spain 2010 - Luxemburg 2011
	MU2E7	Spain 2011 - Spain 2012
	MU2E8	Common Issue "10 Years Euro"
	MU2E9	Belgium 2012 - The Netherlands 2013
	MU2E10	Spain 2013 - Finland 2013
	MU2E11	The Netherlands 2013 - Malta 2014
	MU2E12	Italy 07/2014 - Italy 12/2014
	MU2E13	Common Issue "30 Years European Flag"
	MU2E14	Spain 2014 - France 2015

	Illustrated page incl. Multi collect-coin page MU24	€ 6.50
Volume 2	MU2E15	Italy 2015 - Austria 2016
	MU2E16	Estonia 2016 - Belgium 2016
	MU2E17	Slovenia 2016 - Greece 2016
	MU2E18	Slovakia 2017 - Greece 2017
	MU2E19	Portugal 2017 - Luxemburg 2017
	MU2E20	Italy 2017 - Estonia 2018
	MU2E21	France 2018 - Finland 2018
	MU2E22	France 2018 - Belgium 2019
	MU2E23	Estonia 2019 - Germany 2019
	MU2E24	France 2019 - France 2020
	MU2E25	Luxemburg 2020 - Belgium 2020
	MU2E26	France 2020 - Luxemburg 2021
	MU2E27	France 2021 - Finland 2021
	MU2E28	Lithuania 2021 - Slovenia 2022

Volume 3	MU2E29	Germany 2022 - Luxemburg 2022
	MU2E30	Common Issue „35 Years Erasmus-program“
	MU2E31	Greece 2022 - Lithuania 2023
	MU2E32	Italy 2023 - Spain 2023
	MU2E33	France 2023 - Germany 2024
	MU2E34	Malta 2023 - Portugal 2024
	MU2E35	Italy 2024 - Croatia 2024
	MU2E36	Malta 2024 - Lithuania 2025
	MU2E37	Malta 2025 - Greece 2025

### General indications

- ▶ If needed all illustrated albums will be completed or extended.
- New and updated pages are available separately.

# PUBLICA M COLLECTING ALBUM FOR COINCARDS



Coins are increasingly being issued in the form of Coincards. A Coincard usually contains detailed information about the coin and the occasion of its issue while also providing all-round protection for the enclosed coin. In this collector album, coincards are stored safely and presented in an attractive and representative manner.

**Scope of Delivery:** Ring binder, 10 crystal-clear Multi Collect-pages, each with 8 pockets 93 x 56 mm (MU1364).

**Material Ringbinder:** Synthetic-foil, padded.

**Format Ring binder:** 245 x 270 x 60 mm

**Mechanism:** 4-ring, 45/65/45 mm

**Capacity:** approx. 15 coin pages



Made in Germany



Further storage options include coin boxes (see page 9) and collection boxes (see page 100).

☞ 3539	☞ 3539R	☞ 3531-S
€ 38.50	€ 33.00	€ 21.00

# PUBLICA M ILLUSTRATED ALBUM 20 EURO SILVER COINS GERMANY



Illustrated album with coin illustration for chronological storage of 20 €-Silver coins of Germany.

**Scope of Delivery:** Ring binder, 10 Multi collect-coin pages and 10 illustrated pages (MU20E16 until MU20E25).

**Material Ring binder:** Synthetic-foil, padded

**Format Ring binder:** 270 x 245 x 60 mm

**Mechanism:** 4-ring, 45/65/45 mm

**Capacity:** approx. 15 coin pages

Choose between album with slipcase and album without slipcase.



**Single pages** (Format: 210 x 255 mm)

All pages of this basic edition are also available separately.

☞	Illustrated page incl. Multi collect-coin page MU15	€ 6.50
MU20E16	20 € Silver coins Germany 2016	
MU20E17	20 € Silver coins Germany 2017	
MU20E18	20 € Silver coins Germany 2018	
MU20E19	20 € Silver coins Germany 2019	
MU20E20	20 € Silver coins Germany 2020	
MU20E21	20 € Silver coins Germany 2021	
MU20E22	20 € Silver coins Germany 2022	
MU20E23	20 € Silver coins Germany 2023	
MU20E24	20 € Silver coins Germany 2024	
MU20E25	20 € Silver coins Germany 2025	



Made in Germany

☞ 3536E	☞ 3536M	☞ 3536R	☞ 3531-S
€ 73.50	€ 61.50	€ 33.00	€ 21.00

# PUBLICA M ILLUSTRATED ALBUM

## 35 EURO SILVER COINS

### GERMANY

Illustrated album with coin illustration for chronological storage of 35 €-Silver coins of Germany from 2026 onwards.

**Scope of Delivery:** Ring binder,  
1 Multi collect-coin page and  
1 illustrated page (MU35E26)  
**Material Ring binder:** Synthetic-foil padded  
and sealed  
**Format Ring binder:** 245 x 270 x 60 mm  
**Mechanism:** 4-ring, 45/65/45 mm  
**Capacity:** approx. 15 coin pages

**Single pages** (Format: 210 x 255 mm)  
All pages of this basic edition are also  
available separately.

	Illustrated page incl. Multi collect-coin page MU15	€ 6.50
MU35E26	35 €-Silver coins Germany 2026	

		
 3540M	 3540R	 3531-S
€ 35.50	€ 33.00	€ 21.00



Made in Germany

## CLEANER



Made in EU

€ 62.00/kg

**Coin cleaner on bicarbonate basis (Powder)**  
Especially suitable for gold, silver, copper, nickel, brass and iron.  
Suited for: all coins  
Scope of Delivery: 250 g  
 8135 € 15.50



Made in Germany

€ 54.00/l

**Coin cleaner**  
First cleaning, then dipping.  
Suited for: all coins  
Scope of Delivery: 250 ml  
 8015 € 13.50



Made in Germany

€ 49.33/l

**Cleaning Dip for Silver coins**  
Suited for: Silver coins  
Scope of Delivery: 375 ml  
 8092 € 18.50



Made in Germany

€ 49.33/l

**Cleaning Dip for Gold coins**  
Suited for: Gold coins  
Scope of Delivery: 375 ml  
 8091 € 18.50



 8096, 8098, 8099, 8095: Statements

**Caution**  
H319 Causes serious eye irritation.



Made in Germany

€ 51.60/l

**Cleaning Dip for Gold coins**  
This solution cleans, deoxidises and maintains your coins with brightener and tarnish protection.  
Suited for: Gold coins  
Scope of Delivery: 250 ml  
 8096 € 12.90



Made in Germany

€ 51.60/l

**Cleaning Dip for Copper-nickel coins**  
This solution cleans, deoxidises and maintains your coins with brightener and tarnish protection.  
Suited for: Copper-nickel coins  
Scope of Delivery: 250 ml  
 8098 € 12.90



Made in Germany

€ 51.60/l

**Cleaning Dip for Copper and Brass coins**  
This solution cleans, deoxidises and maintains your coins with brightener and tarnish protection.  
Suited for: Copper and Brass coins  
Scope of Delivery: 250 ml  
 8099 € 12.90



Made in Germany

€ 51.60/l

**Cleaning Dip for Bi-metal coins**  
This solution cleans, deoxidises and maintains your coins with brightener and tarnish protection.  
Suited for: Bi-metal coins e.g. 2 €  
Scope of Delivery: 250 ml  
 8097 € 12.90



Made in Germany

€ 51.60/l

**Cleaning Dip for Silver coins**  
This solution cleans, deoxidises and maintains your coins with brightener and tarnish protection.  
Suited for: Silver coins  
Scope of Delivery: 250 ml  
 8095 € 12.90

Keep all cleaning products out of the reach of children! Safety data sheets can be downloaded from [www.lindner-original.de/en](http://www.lindner-original.de/en).

Prices do not include contents / display material. All prices and specifications are subject to change without prior notice.

## DIGITAL SOLAR-CALIPER

High-quality, digital measuring device made of a carbon fibre compound, with versatile functions and an LCD-display. Can be set to zero position at any time, allowing for differential measuring. Includes feature for measuring depth and internal diameters. Can switch from metric to imperial system. Batteries included.

The carbon fibre compound material guarantees precise and gentle measuring of coins and other objects.

Measuring is possible at any given time, thanks to two energy sources. When the brightness exceeds 200 LUX, the solar cell provides the display with power. When brightness is less than 200 LUX, a 3 Volt Battery supplies the energy.

### Technical data:

Measuring scope: 0-150 mm, 6"  
Precision: +/- 0,2 mm, +/-0,01"  
Measuring units: 0,1 mm, 0,01"

🛒 8044  
€ 29.50



## COIN SCALES

Multi-use cover can be used as weighing tray and covers the scale platform.

(Size 68 x 50 mm). Without batteries.

Format: 115 x 60 x 20 mm

**0,1g**  
**1000g**  
Min./Max.  
Digital pocket coin scale,  
precision from 0,1 g  
Scale area: max. 1000 g  
🛒 8047  
€ 36.50

**0,01g**  
**500g**  
Min./Max.  
Digital pocket coin scale,  
precision from 0,01 g  
Scale area: max. 500 g  
🛒 8046  
€ 39.50



## ULTRASONIC CLEANER

For a gentle and hygienic cleaning of coins, watches, jewellery, glasses, CDs, razor heads, silverware, dentures and much more through ultrasound waves. This Ultrasonic cleaner produces small pressure shafts. These pressure waves create millions of tiny air bubbles. The surface is thoroughly cleaned by rupture of the bubbles. By this process, even the dirt in the corners and recesses is removed and absorbed by the liquid.

- Gently cleaning with water or cleaning liquid
- Stainless steel container
- Fine mesh inlay basket of plastic with watch and CD/DVD holder
- Large viewing window in lid
- Capacity: 750 ml
- LCD-Display
- 5 adjustable time intervals
- Power cable with Euro plug

For optimal results we highly suggest the use of our coin cleaner (8015).

Format: 209 x 195 x 128 mm

🛒 8090  
€ 66.50



## COIN GLOVES

Give your coins extra special care. Use these high-quality gloves when handling your most precious coins! Made of 100% cotton. With wristband, in natural colour. One size fits all!

🛒 8042 (Pair)  
€ 5.50



## COIN GLOVES WITH GRIP

A smooth cotton glove with a good fitting. Excellent grip because of vinyl-nobs on the inside. Velcro seam for better durability. For work that requires sensitivity. The vinyl-nobs on the inside guarantee a safe and easy handling of the coins.

🛒 8045 (Pair)  
€ 7.50



## COIN TONG

It is very important to handle your coins carefully to maintain their quality and protect them from dirt. Never touch coins with your fingers; moisture and skin oils can lead to interaction with the metals. To avoid damage of any kind, it is of utmost importance to handle coins only with a quality coin tong. The tips are covered with a protective coating, which guarantees safe handling of your entire coin collection. They are an essential tool.

Length: 120 mm  
Material coating: soft-PVC

🛒 2014  
€ 5.90



### NERA S

A stylish storage for sets of 4 or 5 coins. Choose between 4 square compartments for coins or capsules up to Ø 52 mm or 5 square compartments for coins or capsules up to Ø 40 mm. The coin inserts display silver as well as gold coins nicely, thanks to a black, velour-like surface.

Format: 243 x 77 x 38 mm



Ø 40 mm 5x

€ 2362-5  
€ 29.50

Ø 52 mm 4x

€ 2362-4  
€ 29.50



### SOLID WOOD CASE CARUS

Solid wood case in a perfect, dark finish. The surface is smooth and shows the natural grain of the wood. The natural grain of the wood on the outside of the lid as well as the inner side enhances each case giving it an individual character. The appearance of each coin case is enhanced by the stable LINDNER-latch. The coin inserts are covered in high-quality black velour.

#### CARUS XM

Format: 250 x 190 x 30 mm

Made in Germany



Ø 52 mm 12x

€ S2489-12  
€ 39.50



Ø 40 mm 15x

€ S2489-15  
€ 39.50

### NERA XM

Our NERA Case XM is the perfect solution for storing 12 or 15 coins. Choose between 12 square compartments for coins or coin capsules up to Ø 52 mm or 15 square compartments for coins or capsules up to Ø 40 mm. The coin inserts with a black, velour-like surface, display silver as well as gold coins.

Format: 243 x 187 x 38 mm



Ø 52 mm 12x

€ 2363-12  
€ 36.50



Ø 40 mm 15x

€ 2363-15  
€ 36.50

### CARUS S

Format: 247 x 76 x 30 mm



Made in Germany



Ø 40 mm 5x

€ S2490-5  
€ 34.00

€ 34.00

Ø 52 mm 4x

€ S2490-4  
€ 34.00



### NERA XS

The smallest version of this series is designed to display that special coin. Whether you are looking for a suitable spot for your favourite collectible or for elegant packaging for a coin gift: our NERA XS offers a variety of purposes. The black velour-like coin insert is a perfect complement to silver or gold coins.

Format: 98 x 88 x 42 mm

Comes with one capsule which features adjustable distance rings. The red rings can be adjusted to the size of the coin. For coin sizes Ø 16-51 mm.

Ø 16-51 mm

€ 2360  
€ 24.50

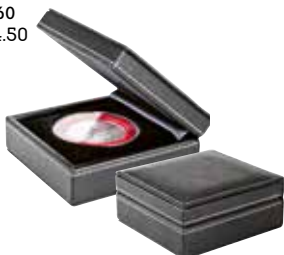

Suited for coins up to Ø 60 mm.

Ø 60 mm

€ 2361  
€ 23.50



With patented "push in"-insert in which you can place any coin up to Ø 70 mm.

Ø 70 mm

€ 2366  
€ 25.50



### COIN CASE FOR ONE SET OF 2 EURO GERMAN COMMEMORATIVE COINS

A black synthetic case with silver inscriptions on the lid and round inserts for keeping and displaying an entire set of 2 Euro German commemorative coins. (All five mint letters).

€ S2090  
€ 4.90



For more products of the NERA series, see page 24-27.



**Coin case incl. patented form-adaptive insert**  
Blue push-in foam insert into which the coin can be pressed.

Ø 50 mm

Format: 65 x 65 x 15 mm  
Material: Synthetic, blue

€ 2027 € 10.50



**Coin case**  
Blue velour insert with square compartment and one synthetic coin envelope.

Ø 40 mm

Format: 75 x 75 x 12 mm  
Material: Synthetic, blue

€ 2020 € 8.00



Made in Germany

**Sleeve made from crystal clear synthetic-foil to hold one complete Euro coin set**  
Made from crystal clear synthetic-foil.

Format: 170 x 67 mm

€ K7ES (Pack of 100) € 39.50



**Coin case for one Euro coin set**  
This attractive case holds one complete coin set from 1 Cent to 2 €.

Format: 90 x 90 mm  
Material: Synthetic, blue

€ 2026 € 10.50



Made in Germany

**Double coin envelope can be folded together**  
Opening is on the inside.  
Material: PVC film acid-free, not completely plasticizer-free.

Ø 30 mm 2x  
Format: approx. 76 x 38 mm (open), 38 x 38 mm (closed)  
€ 4019 (Pack of 100) € 19.90

Ø 40 mm 2x  
Format: approx. 100 x 50 mm (open), 50 x 50 mm (closed)  
€ 2054 (Pack of 100) € 22.50

Ø 60 mm 2x  
Format: approx. 130 x 65 mm (open), 65 x 65 mm (closed)  
€ 4027 (Pack of 100) € 29.90



Made in Germany

**Labelling cards**  
Suitable for Coin envelopes 2050/2051  
Format: approx. 45 x 45 mm

€ 802005 (Pack of 100) € 7.50

**Coin envelopes made of crystal clear synthetic material incl. labelling cards**

Ø 46 mm  
€ 2051-802005 (Pack of 100) € 22.00



Blue velour insert with round compartment and one capsule which features red adjustable distance rings. The rings can be adjusted to the size of the coin.

Material: Synthetic, blue

**Small Coin Case with capsules**  
Ø 16-39 mm  
Format: 60 x 60 x 20 mm  
€ 2002 € 12.50

**Large Coin Case with capsules**  
Ø 16-51 mm  
Format: 80 x 80 x 23 mm  
€ 2003 € 12.90



Blue velour insert with round hollow.

Material: Synthetic, blue

**Small Coin Cases**  
Ø 41 mm  
Format: 60 x 60 x 20 mm  
€ 2006 € 9.90

**Large Coin Case**  
Ø 60 mm  
Format: 80 x 80 x 20 mm  
€ 2007 € 11.50



Made in Germany

**Coin envelopes made of acid-free, white paper**

Ø 46 mm  
Format: approx. 50 x 50 mm  
€ 2053 (Pack of 100) € 11.50  
€ 2052 (Pack of 1000) € 85.00

Ø 66 mm  
Format: approx. 70 x 70 mm  
€ 8473 (Pack of 100) € 16.00  
€ 8472 (Pack of 1000) € 110.00

Special production on request.



Made in Germany

**Coin envelopes made of crystal clear synthetic material**  
Material: PVC film acid-free, not completely plasticizer-free

Ø 46 mm  
Format: approx. 50 x 50 mm  
€ 2051 (Pack of 100) € 16.50  
€ 2050 (Pack of 500) € 72.50

Ø 60 mm  
Format: approx. 64 x 64 mm  
€ 8476 (Pack of 100) € 24.50  
€ 8477 (Pack of 500) € 104.00

Special production on request.



**Pocket coin album for 48 coins**  
With 8 coin pages and coin strip inserts made of softener-free hard-PVC-foil, for 6 coins of Ø 36 mm each. Unpadded cover in different colours. Suited for 48 coins of Ø 36 mm.  
Format: 150 x 100 mm

€ 9.90

- € 2070-3 dark blue
- € 2070-4\* lime
- € 2070-6\* orange
- € 2070-7 black
- € 2070-9\* yellow
- € 2070-10 winered
- € 2070-11 green

Made in EU

# COIN CASE

WITH BLUE VELOUR  
INSERT FOR ALL  
COMMON COINS

Format: 70 x 70 x 15 mm  
Material: Synthetic, blue

each € 10.50



## KARAT-ALBUM FOR 0-EURO SOUVENIR NOTES WITH 10 FOIL PAGES

Padded karat-ring binder made of synthetic material in "Euro Souvenir"-Design with 10 crystal clear, divided foil pages.

**Scope of Delivery:** ring binder, 10 crystal clear, divided foil pages (K02)

**Material Ring binder:** Padded karat-ring binder made of synthetic material in "Euro Souvenir"-Design.

**Format Ring binder:** 210 x 230 x 35 mm

**Mechanism:** 4-ring, 45/65/45 mm

**Capacity:** approx. 50 foil pages.

Foil pages available separately per 10 pages (Order no. K02).



Made in Germany



🛒 1138	🛒 1138R	🛒 810D-S
€ 33.50	€ 28.50	€ 20.50

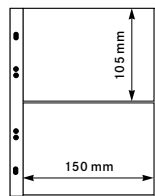

**Additional pages:**  
karat-foil pages with  
2 pockets,  
pack of 10.  
€ 12.50

○ K02

🛒 1138  
€ 33.50

### Protective sleeves for 0-Euro Souvenir notes

Material: Crystal clear, acid and chemical softener free synthetic-foil, pack of 50.

🛒 893LP € 13.00



## PUBLICA M ALBUM FOR 0-EURO SOUVENIR NOTES WITH 10 FOIL PAGES

Padded ring binder PUBLICA M in "Euro Souvenir"-Design, equipped with 10 crystal clear Multi collect- foil pages for 6 items on each page.

**Scope of Delivery:** Ring binder, 10 crystal clear foil pages for 6 items on each page (MU3103)

**Material Ring binder:** Synthetic-foil, padded

**Format Ring binder:** 245 x 270 x 60 mm

**Mechanism:** 4-ring, 45/65/45 mm

**Capacity:** min. 50 foil pages.

Foil pages available separately in pack of 10 (Order-No. MU3103).

🛒 3538  
€ 41.50

🛒 3538	🛒 3538R	🛒 3531-S
€ 41.50	€ 33.00	€ 21.00

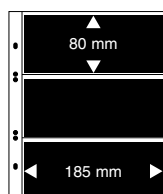

**Additional pages:**  
Multi collect-Banknote pages  
three pockets with black  
inserts, pack of 10.  
€ 12.50

● MU3103



Made in Germany



## BANKNOTE ALBUM REGULAR

For collectors who want the perfect storing for their precious banknotes. The popular LINDNER ring binder 1104 comes with 20 softener-free, crystal clear, hard-PVC-pages and 20 black or white interleaving pages. Slipcases are also available in matching colours.

**Scope of Delivery:**

10 crystal clear pocket pages with 2 pockets 240 x 140 mm each.  
10 crystal clear pocket pages with 3 pockets 240 x 90 mm each.  
20 cardboard interleaving pages.

**Format Ring binder:** 305 x 317 x 50 mm

**Mechanism:** 18-ring

Interleaving pages white	Interleaving pages black	Interleaving pages white	Interleaving pages black
🛒 2810 - G	🛒 2815 - G	🛒 2810-814 - G	🛒 2815-814 - G
🛒 2810 - S	🛒 2815 - S	🛒 2810-814 - S	🛒 2815-814 - S
🛒 2810 - B	🛒 2815 - B	🛒 2810-814 - B	🛒 2815-814 - B
🛒 2810 - H	🛒 2815 - H	🛒 2810-814 - H	🛒 2815-814 - H
🛒 2810 - W	🛒 2815 - W	🛒 2810-814 - W	🛒 2815-814 - W
€ 88.00	€ 88.00	€ 109.00	€ 109.00

Made in Germany

## BANKNOTE ALBUM

Padded LINDNER ring binder in banknote-design with each 5 crystal clear pocket pages with 2 and 3 pockets and interleaving pages. Choose between album with slipcase and album without slipcase.

**Scope of Delivery:**

5 crystal clear pocket pages with 2 pockets 240 x 140 mm each.  
5 crystal clear pocket pages with 3 pockets 240 x 90 mm each.  
10 cardboard interleaving pages.

**Format Ring binder:** 305 x 317 x 50 mm

**Mechanism:** 18-ring

Interleaving pages white	Interleaving pages black	Interleaving pages white	Interleaving pages black	
🛒 3701W	🛒 3701S	🛒 3701W-814	🛒 3701S-814	🛒 3701R
€ 62.50	€ 62.50	€ 83.50	€ 83.50	€ 44.00

Made in Germany

## CRYSTAL CLEAR BANKNOTE-PAGES

Crystal clear pocket pages	crystal clear, incl. white interleaving page		crystal clear, incl. black interleaving page	
1 pocket, 240 x 290 mm	🛒 833	🛒 833P	🛒 853	🛒 853P
2 pockets, 240 x 140 mm	🛒 830	🛒 830P	🛒 850	🛒 850P
3 pockets, 240 x 90 mm	🛒 831	🛒 831P	🛒 851	🛒 851P
4 pockets, 240 x 65 mm	🛒 832	🛒 832P	🛒 852	🛒 852P
	€ 5.00	€ 28.00	€ 5.00	€ 28.00

Other ring binders, for the banknote pages with 18-ring hole punch, can be found on page 72-74.

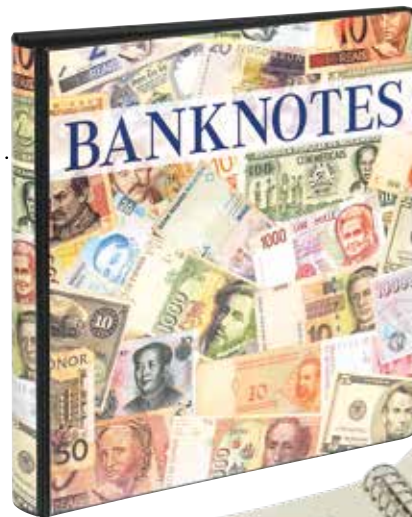

## BANKNOTE ALBUM MULTI BIG

Padded MULTI BIG ring binder made of synthetic-foil in banknote design with 20 crystal-clear MULTI BIG foil sheets made of plasticiser-free rigid PVC foil, each with 2 oversized pockets, for documents up to 230 x 130 mm. The pockets can be double-filled thanks to the black film insert strips. This means that each sheet has space for up to 4 large banknotes/receipts. The foil insert strips are removable. This makes it possible to fill the pockets with just one slip and the front and back of the contents can be viewed.

**Capacity:** approx. 50 Multi collect pages.  
**Format Ring binder:** 280 x 270 x 70 mm  
**Mechanism:** 4-ring, 40/80/40 mm



Made in Germany



### MULTI COLLECT-PAGES FOR BANKNOTES

Material: Acid and softener free hard-PVC-foil.

crystal clear, with black inserts

● MU 1384  
 Pack of 10  
 € 12.50



Made in Germany



## BANKNOTE ALBUM SRS

Sturdy ring binder with black cover made of padded synthetic-foil. The grained surface in leather-effect gives this ring binder its individual character. The standard mechanism allows an universal use. Includes 2 black cover sheets.

### Scope of Delivery:

10 crystal clear pocket pages with 2 pockets 240 x 140 mm each.  
 10 crystal clear pocket pages with 3 pockets 240 x 90 mm each.  
 20 white cardboard interleaving pages.

**Format Ring binder:** 305 x 317 x 50 mm

**Mechanism:** 4-ring, 80/80/80 mm (also suitable for 18-ring)

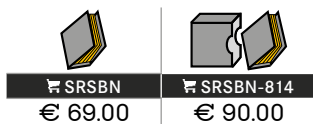

### CRYSTAL CLEAR BANKNOTE-PAGES

Crystal clear pocket pages	crystal clear, incl. white interleaving page		crystal clear, incl. black interleaving page	
	1x	10x	1x	10x
1 pocket, 240 x 290 mm	833	833P	853	853P
2 pockets, 240 x 140 mm	830	830P	850	850P
3 pockets, 240 x 90 mm	831	831P	851	851P
4 pockets, 240 x 65 mm	832	832P	852	852P
	€ 5.00	€ 28.00	€ 5.00	€ 28.00

**PROTECTIVE SLEEVES FOR BANKNOTES**  
 see page 57.

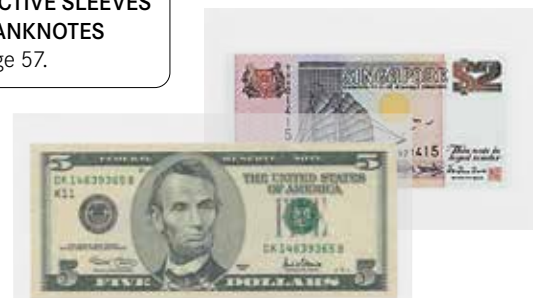

More uses for the SRS ring binders can be found on page 75.



Made in Germany

## PUBLICA M BANKNOTE ALBUM

Padded PUBLICA M ring binder with 20 Multi collect-banknote pages with 2 pockets each. With slipcase made of laminated cardboard. Due to the removable black foil inserts, the pockets can be used as double-sided pages, or you can view both sides of the note single-sided.

### Scope of Delivery:

20 Multi collect-banknote pages with 2 pockets 185 x 120 mm each (MU1404).

**Format Ring binder:** 250 x 280 x 75 mm incl. slipcase

**Mechanism:** 4-ring Universal, 45/65/45 mm

Details as well as other possibilities for using our versatile Multi collect-system are found on page 40-43.



Made in Germany

## MULTI COLLECT-SYSTEM FOR BANKNOTES

Ring binder made of padded synthetic-foil. The grained surface in leather-effect gives the ring binder its individual character. The typical 4-ring mechanism of the Multi collect-ring binder guarantees a simple handling and the ring binder impresses with its large capacity. The generous spine window offers space for content listing.

**Format Ring binder:** 245 x 270 x 80 mm

**Mechanism:** 4-ring, 40/80/40 mm

Details as well as other possibilities for using our versatile Multi collect-system are found on page 40-43.

1302 - G	1300 - G	1301 - G
1302 - S	1300 - S	1301 - S
1302 - B	1300 - B	1301 - B
1302 - H	1300 - H	1301 - H
1302 - W	1300 - W	1301 - W
€ 51.00	€ 34.50	€ 26.00

## MULTI COLLECT-PAGES FOR BANKNOTES

Material: Acid and softener-free hard-PVC foil.

- **black, double-sided**  
Pack of 10 € 12.50
- **crystal clear**  
Pack of 10 € 11.50
- **crystal clear, with black inserts**  
Pack of 10 € 12.50

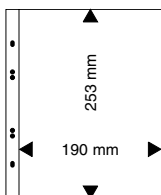

● MU1311  
○ MU1321

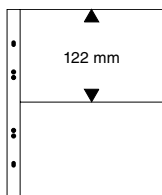

● MU1312  
○ MU1322

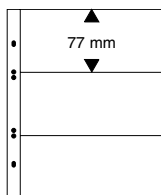

● MU1313  
○ MU1323

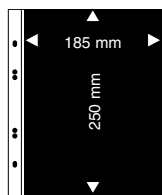

● MU1405

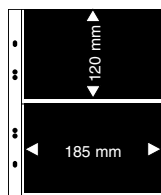

● MU1404

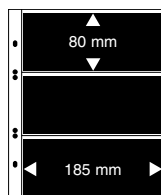

● MU3103

### Interleaving pages

Interleaves are recommended for interleaving purposes, pack of 20. MU1385 € 8.50

Black paper interleaving pages, pack of 10. MU1386 € 8.50

## PUBLICA LS FOR BANKNOTES

Ring binder made of padded synthetic-foil with standard mechanism. For space-saving, safety and representative storing. The large index window on the spine offers space for content labelling. Suitable for our stockpages and other pages in DIN A4 format with standard hole punch.

**Format Ring binder:** 290 x 315 x 60 mm

**Mechanism:** 4-ring, 80/80/80 mm



Made in Germany

🛒 3533 - G	🛒 3503 - G	🛒 3504 - G
🛒 3533 - S	🛒 3503 - S	🛒 3504 - S
🛒 3533 - B	🛒 3503 - B	🛒 3504 - B
🛒 3533 - H	🛒 3503 - H	🛒 3504 - H
🛒 3533 - W	🛒 3503 - W	🛒 3504 - W
€ 57.00	€ 41.00	€ 26.50

Matching pages for banknotes in black or crystal clear:

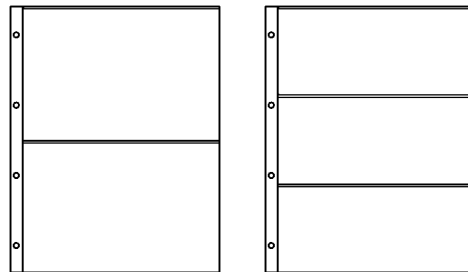

2 strips  
150 x 220 mm

3 strips  
97 x 220 mm

Pack of 10

● 4102 € 21.00  
○ 8812 € 20.00

Pack of 10

● 4103 € 21.00  
○ 8813 € 20.00



Details as well as other possibilities for using our versatile PUBLICA-system are found on page 95-97.

## BANKNOTE ALBUM PUBLICA M

Padded ring binder PUBLICA M in banknote-design with 20 Multi collect-banknote pages with 2 and 3 pockets.

With black slipcase made of laminated cardboard. Due to the removable black foil inserts, the pockets can be used as double-sided pages, or you can view both sides of the note single-sided.

**Scope of Delivery:**

10 Multi collect-banknote pages with 2 pockets 185 x 120 mm each (MU1404)

10 Multi collect-banknote pages with 3 pockets 185 x 80 mm each (MU3103)

**Format Ring binder:** 245 x 270 x 60 mm

**Mechanism:** 4-ring Universal, 45/65/45 mm



Made in Germany

🛒 3537E	🛒 3537	🛒 3537R
€ 55.50	€ 46.00	€ 33.00

Details as well as other possibilities for using our versatile Multi collect-system are found on page 40-43.



## FIRMO UNIVERSAL ALBUMS

The FIRMO Universal albums made of a high-quality leatherette cover offers plenty of space for banknotes, FDC's, letters, photos, postcards etc. The crystal clear synthetic sleeves with black paper inserts are made of PVC-foil that can be used from both sides. The pages open at the inner side so that the documents are protected from dirt and falling out. The albums are carefully produced and are characterised by their plain elegance.



- 812XL-R
- 812XL-B
- 812XL-S

### FIRMO XL

With 56 crystal clear synthetic sleeves that can be used from both sides. The black paper inserts can be used as a divider.

For 224 items up to the size of 245 x 132 mm.

Format: 285 x 305 x 75 mm

🏷️ 812XL  
€ 39.50



- 812L-R
- 812L-B
- 812L-S

### FIRMO L

With 54 crystal clear synthetic sleeves that can be used from both sides. The black paper inserts can be used as a divider.

For 108 items up to the size of 245 x 132 mm.

Format: 285 x 155 x 75 mm

🏷️ 812L  
€ 21.50



- 812-R
- 812-B
- 812-S

### FIRMO

With 54 crystal clear synthetic sleeves that can be used from both sides. The black paper inserts can be used as a divider.

For 108 items up to the size of 190 x 130 mm.

Format: 230 x 155 x 75 mm

🏷️ 812  
€ 18.50



### POCKET ALBUM FOR BANKNOTES

Handy pocket album with padded dark blue synthetic cover. With 20 crystal clear sleeves. Ideal for e.g. banknotes, postcards or other receipts or documents.



- S818

- S817

Format: 230 x 155 x approx. 20 mm  
Suited for: Banknotes, documents up to 210 x 125 mm.

🏷️ S818  
€ 14.50





Format: 195 x 110 x approx. 20 mm  
Suited for: Banknotes, documents up to 175 x 85 mm.

🏷️ S817  
€ 10.50

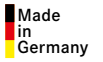
## PROTECTIVE SLEEVES FOR BANKNOTES

All protective sleeves are made from a crystal clear, acid and chemical softener-free synthetic-foil. Film thickness: 0.1 mm.  
All measurements are internal measurements in mm. The red line identifies the open side.

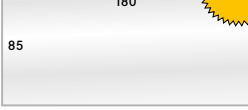





 <b>893LP</b> e.g. for Banknotes Pack of 50 € 13.00	 <b>895LP</b> e.g. for Banknotes US-Dollar Pack of 50 € 13.00	 <b>897LP</b> e.g. for banknotes, suitable for banknote sheet 831/851 (p.71) Pack of 50 € 15.50	 <b>883LP</b> e.g. for FDC Pack of 50 € 15.50	 <b>886LP</b> e.g. for European Envelopes long Pack of 50 € 15.50
--	---	--	--	---

## FREESTYLE PROTECTIVE SLEEVES FOR BANKNOTES

### FOIL SHEETS OF OUR RENOWNED PROTECTIVE COVERS

### WITH SELF-ADHESIVE STRIP ON THE LEFT SIDE

Using the self-adhesive strip, the covers can be mounted individually on each album page.  
In this way, the protective covers can be integrated into any conventional collection system.

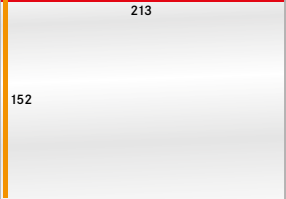
 <b>S893LH</b> e.g. for Banknotes Pack of 25 € 13.00	 <b>S895LH</b> e.g. for Banknotes US-Dollar Pack of 25 € 13.00	 <b>S883LH</b> e.g. for FDC Pack of 25 € 15.50	 <b>S886LH</b> e.g. for European Envelopes long Pack of 25 € 15.50	 <b>S888LH</b> e.g. for DIN A5, ETB's Pack of 25 € 20.50
---	--	--	---	--

A detailed description of the LINDNER protective sleeves or LINDNER T-freestyle protective sleeves with all possibilities can be found on page 92/93.

## FOLDING SLEEVES WITH FLAP FOR BANKNOTES

Simple and gentle insertion and protection of the collectibles. Simply open and insert slip, close and secure with folding flap. Best protection made of hard-PVC-foil.

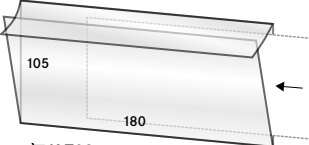
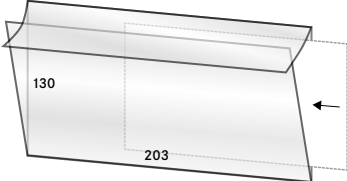
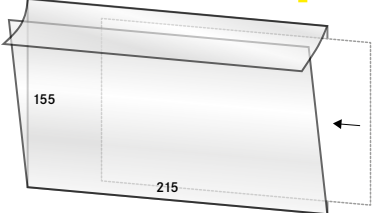

 <b>K-T92</b> for Banknotes up to 178 x 103 mm Pack of 50 € 24.90	 <b>K-T93</b> for Banknotes up to 201 x 127 mm Pack of 50 € 25.90	 <b>K-T96</b> for Banknotes up to 214 x 152 mm Pack of 50 € 30.90
--	---	--

Identification according to Regulation (EC) No. 1272/2008 Statements:

**ERNI A (8070)**

**Caution**

- H315 Causes skin irritation.
- H319 Causes serious eye irritation.
- H411 Toxic to aquatic life with long lasting effects.



**ERNI B (8071)**

**Caution**

- H290 Can be corrosive to metals.
- H315 Causes skin irritation.
- H319 Causes serious eye irritation.
- H317 Can cause allergic reactions to your skin.
- H351 Suspected of causing cancer.
- H373 May cause damage to organs through prolonged or repeated exposure.



## ERNI CARE PRODUCTS

It's all about retaining the value and perfection!  
Content: 200 ml.

To remove mold stains in three simple steps.  
ERNI A disinfects, with ERNI B you wash out.

**ERNI A and ERNI B must be used together.**

**Please follow the instructions for proper cleaning.**

- 8070 ERNI A, 200 ml € 21.00
- 8071 ERNI B, 200 ml € 21.00



before cleaning

after cleaning

## LINDNER T-SYSTEM

Each page of the LINDNER T-system is made of a PERMAPHIL®-cardboard page and a hard-PVC-foil sheet which is fixed on the left side of the page. The foil sheets are softer and acid free. You can choose between many variations of insertion strips in different heights and widths. The stamps are inserted into the foil strips and are thereby protected on both sides. Due to the quality of the foil, you always have a “crystal clear” view of your stamps. The gentle clamp effect of the foil seam, which is produced by a special foil welding process, ensures that the stamps stay at their intended place. The foil sheet is glued on the cardboard sheet by a special adhesive process at the left side. This allows a simple leafing. Because of this, you can easily have a look on the front and the rear of the stamps without taking them out of the foil sheet. This is a typical character of the LINDNER T-system. The high-quality of material and production ensure an easy remove of the stamps, without the fear of damage. All pages of the LINDNER T-system have 18-ring hole punch, which gives them a sturdy hold in all LINDNER ring binders with 18-ring mechanism. The LINDNER ring binders can be found on page 72-74.

## LINDNER T-ILLUSTRATED COUNTRY ALBUMS

Illustrated stamp pages were developed for those collectors who like to collect certain or several countries, with the entire stamp issue years. The stamps are depicted on the card pages and provide a fixed place for the stamps. This helps to portray each issue. Our employees in the LINDNER philatelic department collect and process issued stamps of over 150 countries for you. For those who collect internationally, there is no way around using our illustrated pages. They ensure that our collector owns the complete collection. Stamps will illustrate events of a country, they inform you about parts of the world, organisations and communities, allow insights into cultures and tell of highlights in history, politics and science. Stamps allow you to experience international events up close. The illustrated pages provide anticipation for stamps which have not yet been issued, and tell you which stamps still need to be found. Place the stamp in the provided place in the foil sheets. You can lay the stamp directly over the stamp illustration on the page. The stamp now lies entirely protected by the sheet foil. Each year, supplements are issued for the previous year, ensuring that your collection is always up to date.

## LINDNER DOUBLE T-ILLUSTRATED PAGES

The LINDNER double T-illustrated stamp pages were developed for collectors, who wish to collect the new stamps as well as used stamps and do not want to purchase two sets of illustrated pages. The stamps are printed on both back and front side of these card pages. The foil sheets are glued on both front and back of the page, so that you can keep the new stamps on the front side and the used stamps on the reverse.





The beginnings of the album productions in Schömberg around 1950.

## LINDNER T-BLANK AND LINDNER DT-BLANK-SYSTEM FOR THE TOPICAL OR THE CREATIVE INDIVIDUAL COLLECTOR

This system offers countless possibilities for the individualists and creative collectors who like to design their own stamp collections. Unlike the illustrated pages, these pages are not printed but remain blank. The LINDNER T-Blank-system has over 80 different page variations with different foil sheet strips for an individual set up of stamp collecting.

An advantage in the LINDNER T-Blank-system is that the stamps can always be removed or the page rearranged. The page will not be damaged and can be used to design a new collection. For collectors that like to add text or pictures, we offer the LINDNER write-up pages with many possibilities.

The write-up pages can be designed by hand or on the computer and are then placed between the card page and foil sheet, turning each page into an individual eye-catcher. The size of the write-up pages corresponds to the different kinds of T-Blank-pages.

## LINDNER PAPER QUALITY

All LINDNER systems use the exclusive PERMAPHIL®-cardboard, which protects a stamp collection from the aging process and harmful environmental influences for decades. Impressive facts about our PERMAPHIL®-cardboard:

- a pH value of more than 7.5 which makes it acid free,
- age resistant due to a low calcium carbonate content,
- free of optical brighteners,
- free of acid-forming components,
- bleached without chlorine,
- firm album quality,
- paper weight: 200 g / sqm.



# T-BLANK-PAGES

This system offers countless possibilities for the individualists and creative collectors who like to design their own stamp collections. Unlike the illustrated pages, these pages are not printed but remain blank. The LINDNER T-Blank-system has over 80 different page variations with different foil sheet strips for an individual set up of stamp collecting.

An advantage in the LINDNER T-Blank-system is that the stamps can always be removed or the page rearranged. The page will not be damaged and can be used to design a new collection. For collectors that like to add text or pictures, we offer the LINDNER write-up pages with many possibilities.

The write-up pages can be designed by hand or on the computer and are then placed between the card page and foil sheet, turning each page into an individual eye-catcher. The size of the write-up pages corresponds to the different kinds of T-Blank-pages.

All LINDNER systems use the exclusive PERMAPHIL®-cardboard, which protects a stamp collection from the aging process and harmful environmental influences. Keep your stamp collection in pristine condition for decades.

Format: 272 x 296 mm  
Paper weight: 200 g / sqm

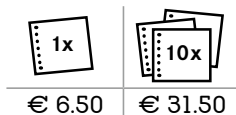

**INSERTS FOR WRITE-UPS**  
see page 64.

Made in Germany

## ADVANTAGE OFFER: COMPANION SET REGULAR (1124) INCL. 2 PACKAGES T-BLANK PAGES OR DT-BLANK PAGES OF YOUR CHOICE

**Scope of Delivery:**  
Companion set REGULAR (Order-Nr. 1124),  
incl. 2x pack of 10 T-Blank Pages of your choice  
or 2x pack of 5 dt-Blank Pages of your choice.



Made in Germany

- 1124TB - G
  - 1124TB - S
  - 1124TB - B
  - 1124TB - H
  - 1124TB - W
- € 124.50

### 1 POCKET

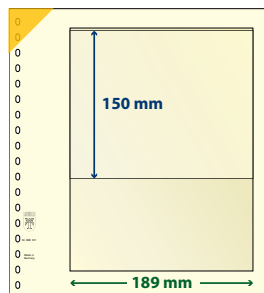

802101  
802101P (Pack of 10)  
Matching inserts for write-ups: A

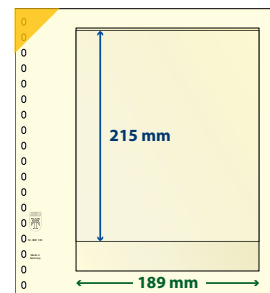

802102  
802102P (Pack of 10)  
Matching inserts for write-ups: A

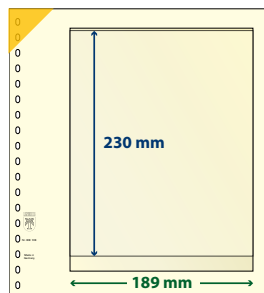

802108  
802108P (Pack of 10)  
Matching inserts for write-ups: A

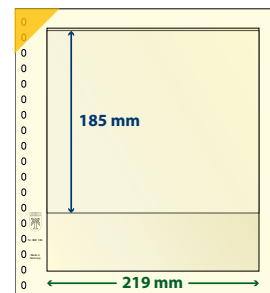

802109  
802109P (Pack of 10)  
Matching inserts for write-ups: B

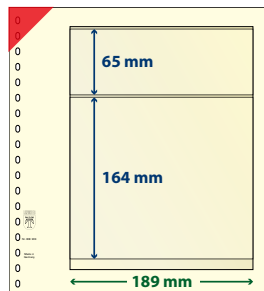

802203  
802203P (Pack of 10)  
Matching inserts for write-ups: A

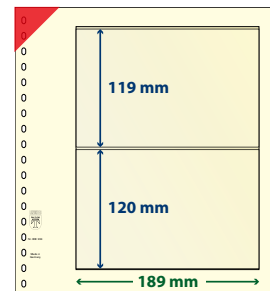

802204  
802204P (Pack of 10)  
Matching inserts for write-ups: A

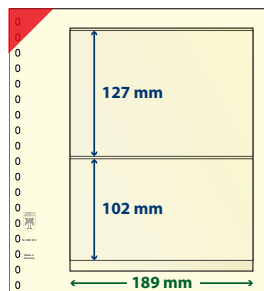

802210  
802210P (Pack of 10)  
Matching inserts for write-ups: A

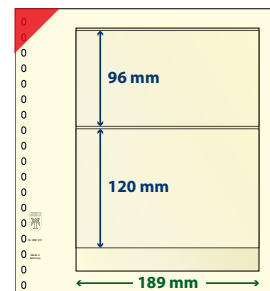

802211  
802211P (Pack of 10)  
Matching inserts for write-ups: A

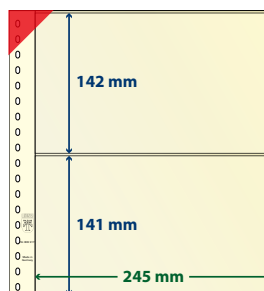

802217  
802217P (Pack of 10)  
Matching inserts for write-ups: E

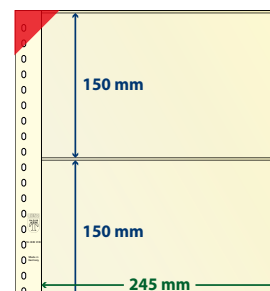

802218  
802218P (Pack of 10)  
Matching inserts for write-ups: E

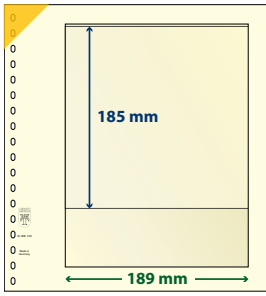

802103  
802103P (Pack of 10)  
Matching inserts for write-ups: A

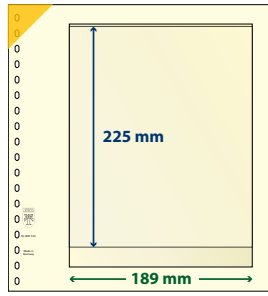

802104  
802104P (Pack of 10)  
Matching inserts for write-ups: A

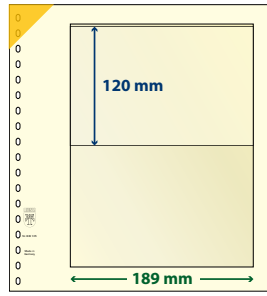

802105  
802105P (Pack of 10)  
Matching inserts for write-ups: A

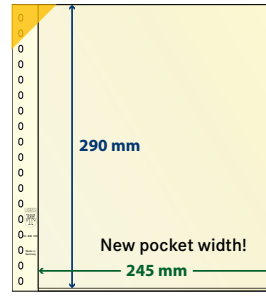

802106  
802106P (Pack of 10)  
Matching inserts for write-ups: E

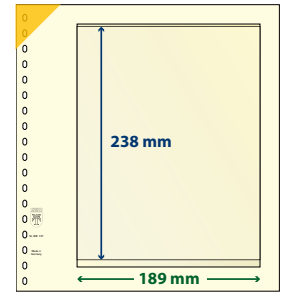

802107  
802107P (Pack of 10)  
Matching inserts for write-ups: A

**2 POCKETS**

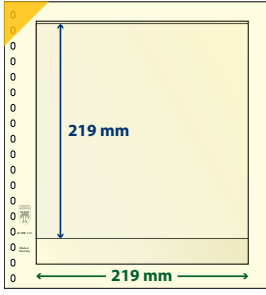

802110  
802110P (Pack of 10)  
Matching inserts for write-ups: B

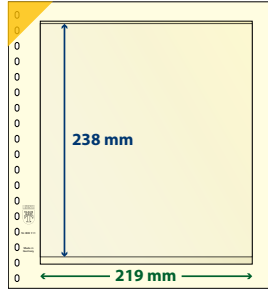

802111  
802111P (Pack of 10)  
Matching inserts for write-ups: B

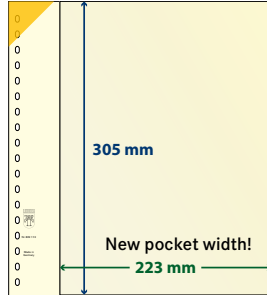

802112  
802112P (Pack of 10)  
Format: 272 x 305 mm

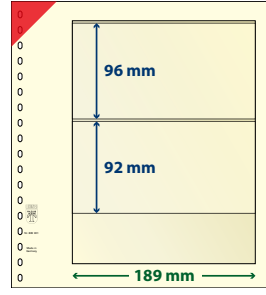

802201  
802201P (Pack of 10)  
Matching inserts for write-ups: A

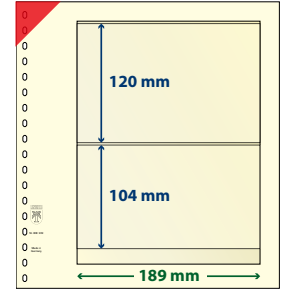

802202  
802202P (Pack of 10)  
Matching inserts for write-ups: A

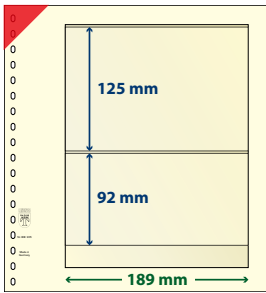

802205  
802205P (Pack of 10)  
Matching inserts for write-ups: A

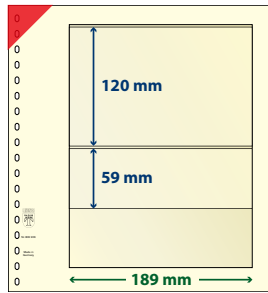

802206  
802206P (Pack of 10)  
Matching inserts for write-ups: A

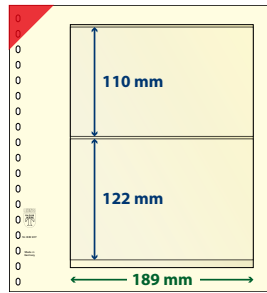

802207  
802207P (Pack of 10)  
Matching inserts for write-ups: A

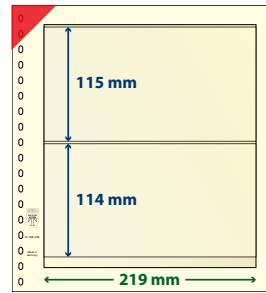

802208  
802208P (Pack of 10)  
Matching inserts for write-ups: B

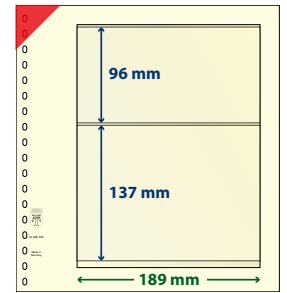

802209  
802209P (Pack of 10)  
Matching inserts for write-ups: A

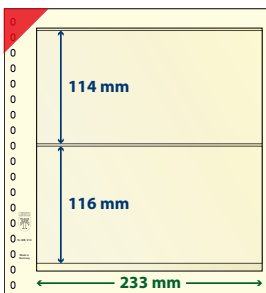

802212  
802212P (Pack of 10)  
Matching inserts for write-ups: C

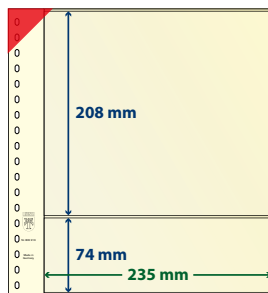

802213  
802213P (Pack of 10)  
Matching inserts for write-ups: D

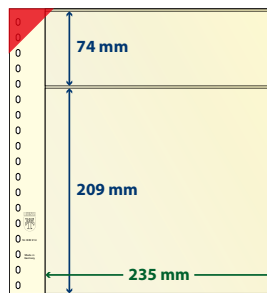

802214  
802214P (Pack of 10)  
Matching inserts for write-ups: D

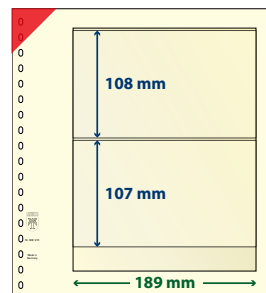

802215  
802215P (Pack of 10)  
Matching inserts for write-ups: A

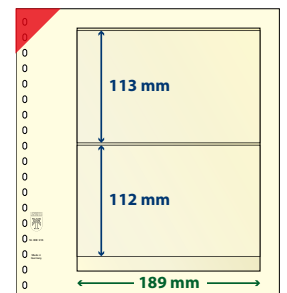

802216  
802216P (Pack of 10)  
Matching inserts for write-ups: A

**3 POCKETS**

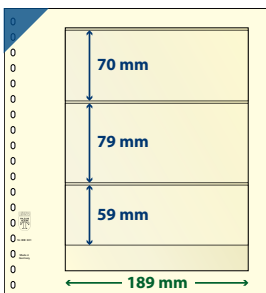

802301  
802301P (Pack of 10)  
Matching inserts for write-ups: A

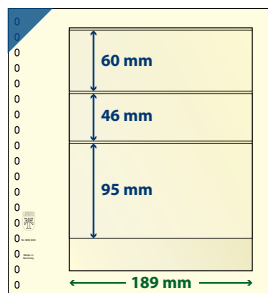

802302  
802302P (Pack of 10)  
Matching inserts for write-ups: A

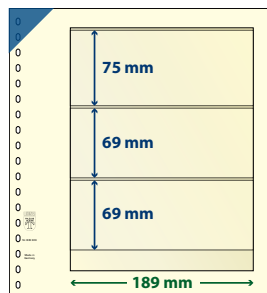

802303  
802303P (Pack of 10)  
Matching inserts for write-ups: A

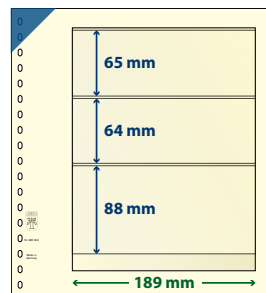

802304  
802304P (Pack of 10)  
Matching inserts for write-ups: A

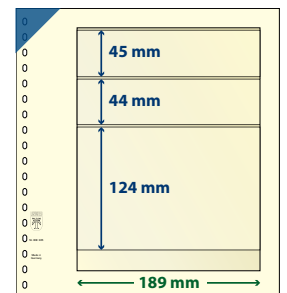

802305  
802305P (Pack of 10)  
Matching inserts for write-ups: A

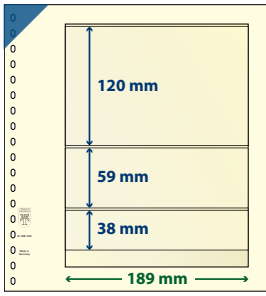

802306  
802306P (Pack of 10)  
Matching inserts for write-ups: A

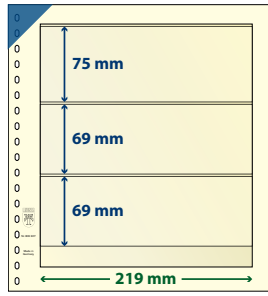

802307  
802307P (Pack of 10)  
Matching inserts for write-ups: B

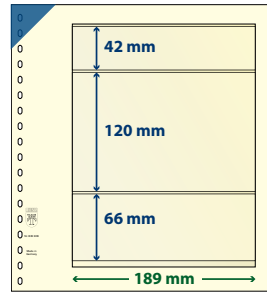

802308  
802308P (Pack of 10)  
Matching inserts for write-ups: A

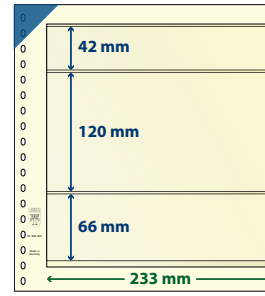

802309  
802309P (Pack of 10)  
Matching inserts for write-ups: C

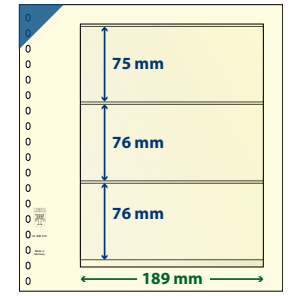

802310  
802310P (Pack of 10)  
Matching inserts for write-ups: A

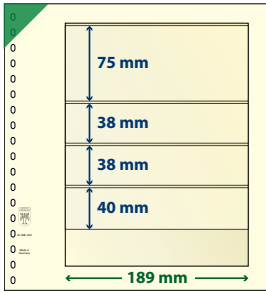

802403  
802403P (Pack of 10)  
Matching inserts for write-ups: A

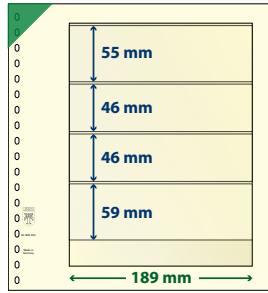

802404  
802404P (Pack of 10)  
Matching inserts for write-ups: A

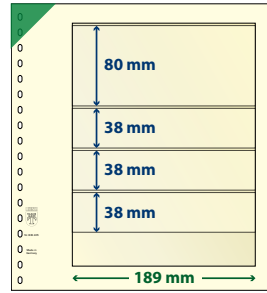

802405  
802405P (Pack of 10)  
Matching inserts for write-ups: A

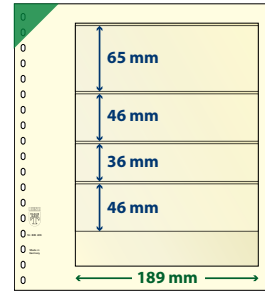

802406  
802406P (Pack of 10)  
Matching inserts for write-ups: A

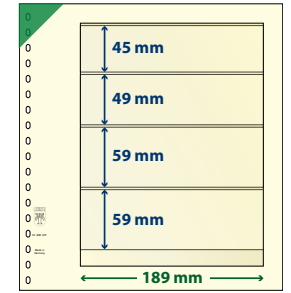

802407  
802407P (Pack of 10)  
Matching inserts for write-ups: A

### 5 POCKETS

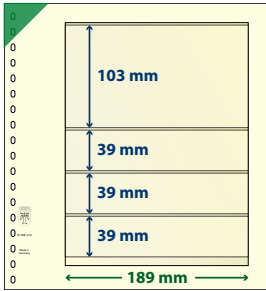

802413  
802413P (Pack of 10)  
Matching inserts for write-ups: A

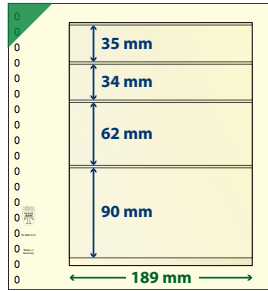

802414  
802414P (Pack of 10)  
Matching inserts for write-ups: A

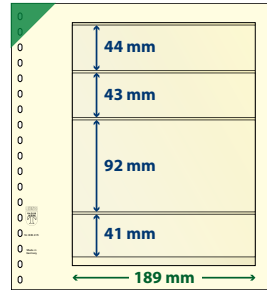

802415  
802415P (Pack of 10)  
Matching inserts for write-ups: A

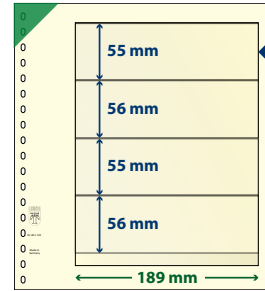

802420 short side open  
802420P (Pack of 10)  
Open at the short side  
Matching inserts for write-ups: A

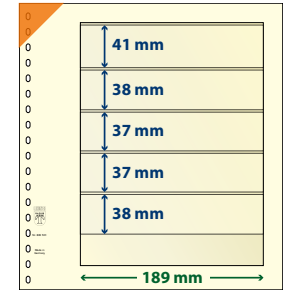

802501  
802501P (Pack of 10)  
Matching inserts for write-ups: A

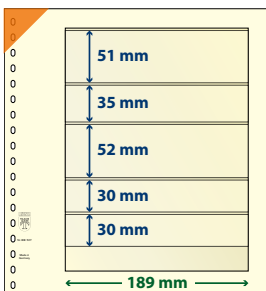

802507  
802507P (Pack of 10)  
Matching inserts for write-ups: A

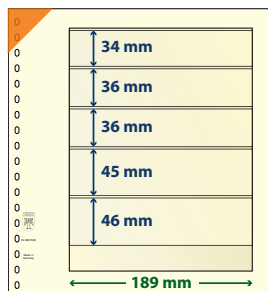

802508  
802508P (Pack of 10)  
Matching inserts for write-ups: A

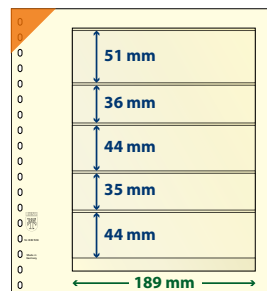

802509  
802509P (Pack of 10)  
Matching inserts for write-ups: A

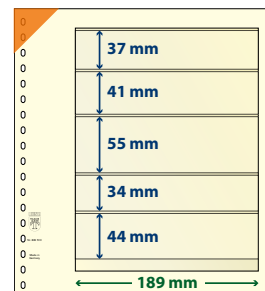

802510  
802510P (Pack of 10)  
Matching inserts for write-ups: A

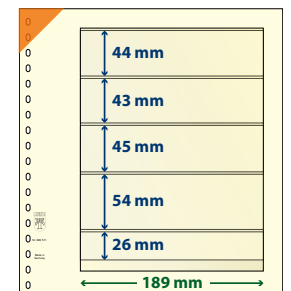

802511  
802511P (Pack of 10)  
Matching inserts for write-ups: A

### 7 POCKETS

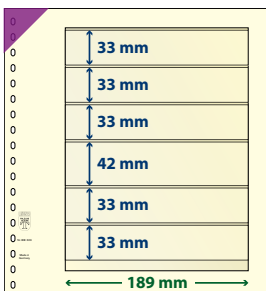

802603  
802603P (Pack of 10)  
Matching inserts for write-ups: A

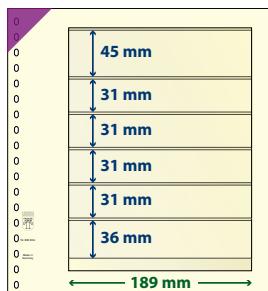

802604  
802604P (Pack of 10)  
Matching inserts for write-ups: A

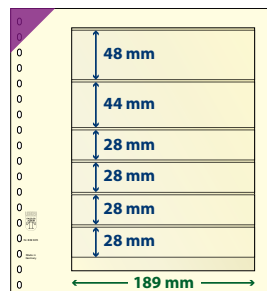

802605  
802605P (Pack of 10)  
Matching inserts for write-ups: A

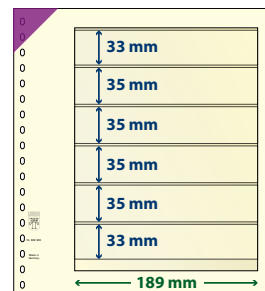

802606  
802606P (Pack of 10)  
Matching inserts for write-ups: A

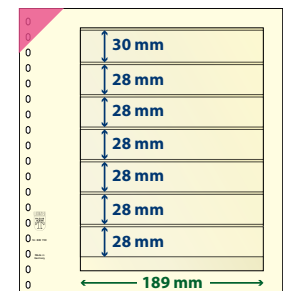

802700  
802700P (Pack of 10)  
Matching inserts for write-ups: A

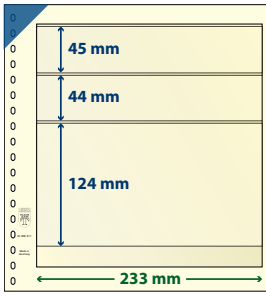

802311  
802311P (Pack of 10)  
Matching inserts for write-ups: C

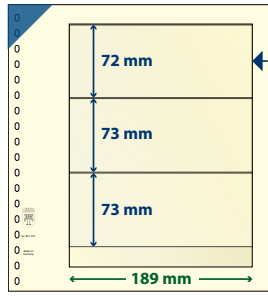

802320  
802320P (Pack of 10)  
Open at the short side  
Matching inserts for write-ups: A

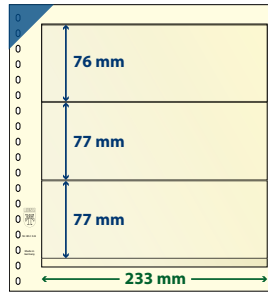

802322  
802322P (Pack of 10)  
Open at the short side  
Matching inserts for write-ups: C

4 POCKETS

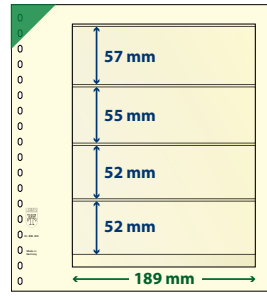

802400  
802400P (Pack of 10)  
Matching inserts for write-ups: A

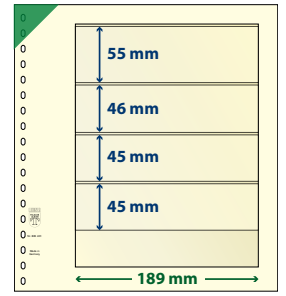

802401  
802401P (Pack of 10)  
Matching inserts for write-ups: A

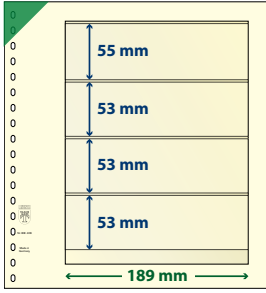

802408  
802408P (Pack of 10)  
Matching inserts for write-ups: A

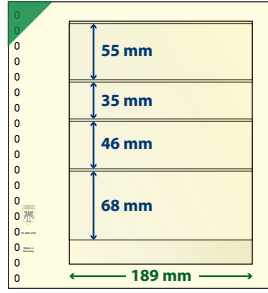

802409  
802409P (Pack of 10)  
Matching inserts for write-ups: A

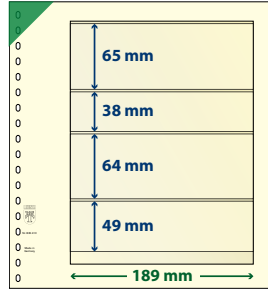

802410  
802410P (Pack of 10)  
Matching inserts for write-ups: A

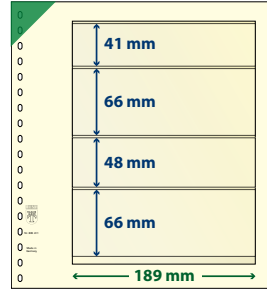

802411  
802411P (Pack of 10)  
Matching inserts for write-ups: A

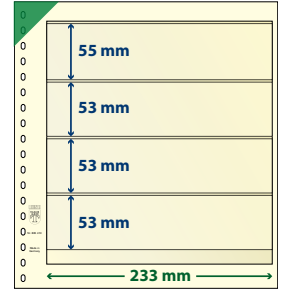

802412  
802412P (Pack of 10)  
Matching inserts for write-ups: C

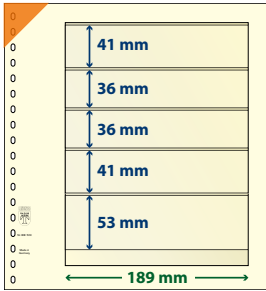

802502  
802502P (Pack of 10)  
Matching inserts for write-ups: A

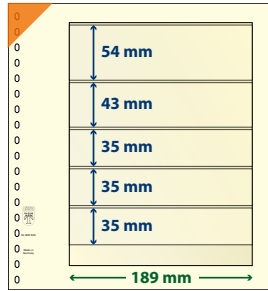

802503  
802503P (Pack of 10)  
Matching inserts for write-ups: A

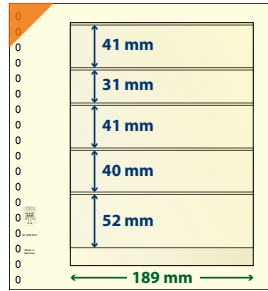

802504  
802504P (Pack of 10)  
Matching inserts for write-ups: A

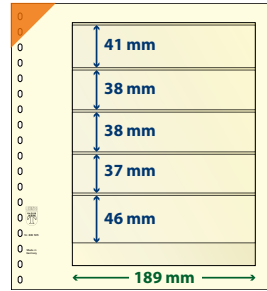

802505  
802505P (Pack of 10)  
Matching inserts for write-ups: A

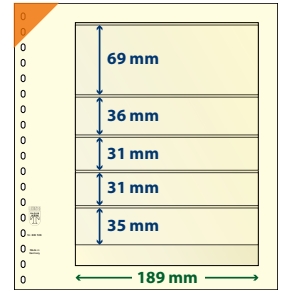

802506  
802506P (Pack of 10)  
Matching inserts for write-ups: A

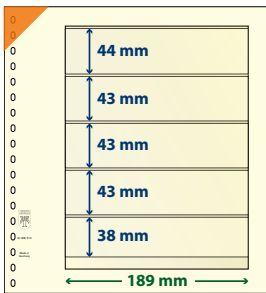

802512  
802512P (Pack of 10)  
Matching inserts for write-ups: A

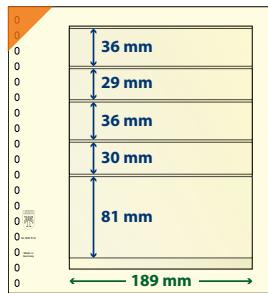

802513  
802513P (Pack of 10)  
Matching inserts for write-ups: A

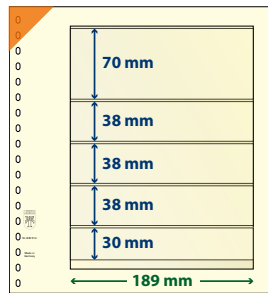

802514  
802514P (Pack of 10)  
Matching inserts for write-ups: A

6 POCKETS

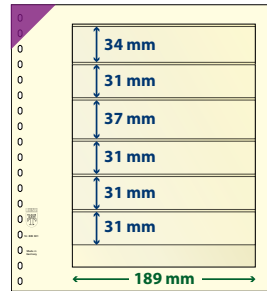

802601  
802601P (Pack of 10)  
Matching inserts for write-ups: A

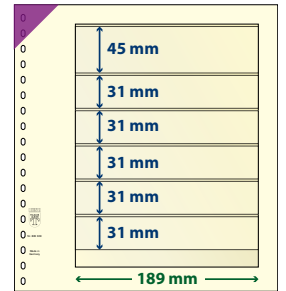

802602  
802602P (Pack of 10)  
Matching inserts for write-ups: A

8 POCKETS

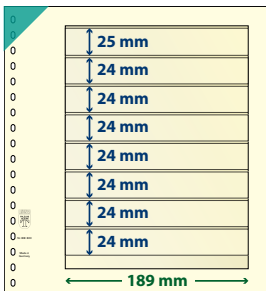

802800  
802800P (Pack of 10)  
Matching inserts for write-ups: A

PAGES WITH VERTICAL POCKETS

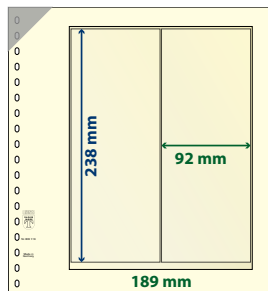

802119  
802119P (Pack of 10)  
Pages with vertical pockets  
Matching inserts for write-ups: A

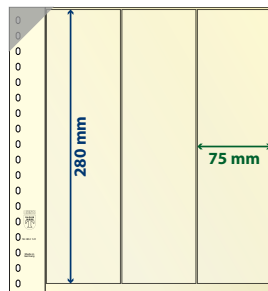

802121  
802121P (Pack of 10)  
Pages with vertical pockets  
Matching inserts for write-ups: D

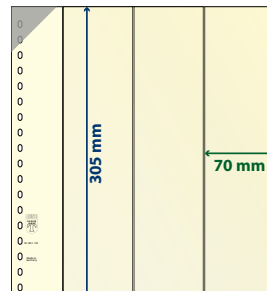

802122  
802122P (Pack of 10)  
Pages with vertical pockets  
Format: 272 x 305 mm

1x | 10x  
€ 6.50 | € 31.50

# dT-BLANK-PAGES

THE MOST POPULAR T-BLANK-PAGES ARE ALSO AVAILABLE IN THE DT-VERSION WITH FOIL SHEETS ON BOTH SIDES

## 1 POCKET

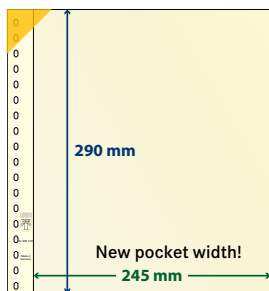

dt802106P (Pack of 5)  
Matching inserts for write-ups: E

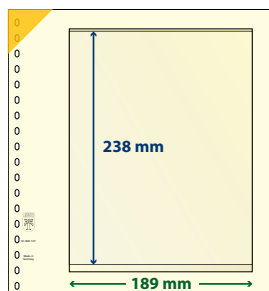

dt802107P (Pack of 5)  
Matching inserts for write-ups: A

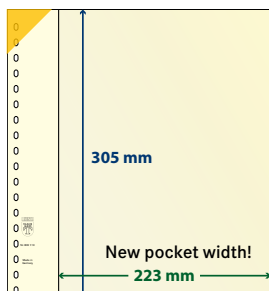

dt802112P (Pack of 5)  
Format: 272 x 305 mm

## 2 POCKETS

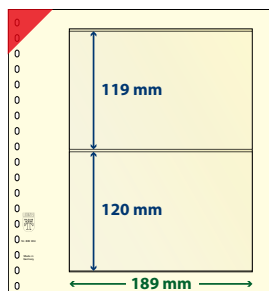

dt802204P (Pack of 5)  
Matching inserts for write-ups: A

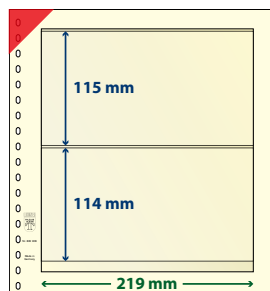

dt802208P (Pack of 5)  
Matching inserts for write-ups: B

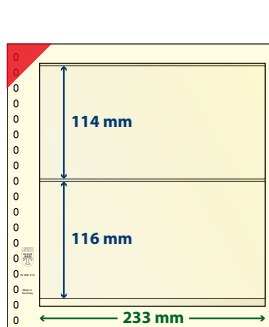

dt802212P (Pack of 5)  
Matching inserts for write-ups: C

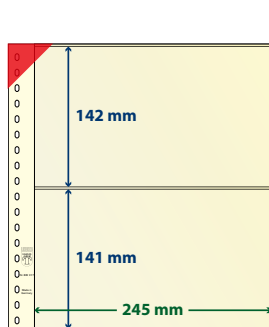

dt802217P (Pack of 5)  
Matching inserts for Write-Ups: E

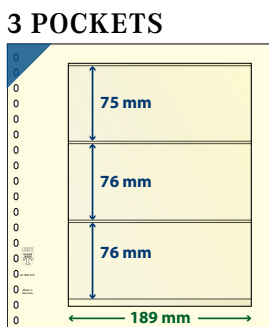

dt802310P (Pack of 5)  
Matching inserts for write-ups: A

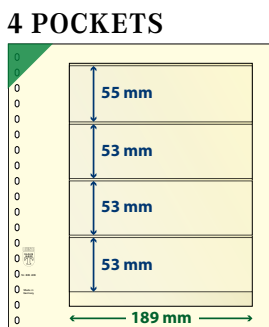

dt802408P (Pack of 5)  
Matching inserts for write-ups: A

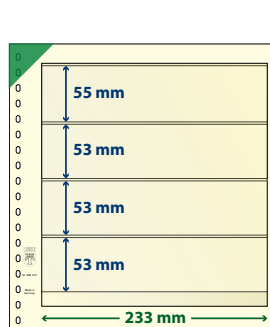

dt802412P (Pack of 5)  
Matching inserts for write-ups: C

## 5 POCKETS

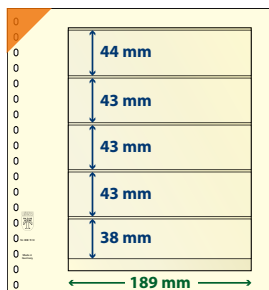

dt802512P (Pack of 5)  
Matching inserts for write-ups: A

## 6 POCKETS

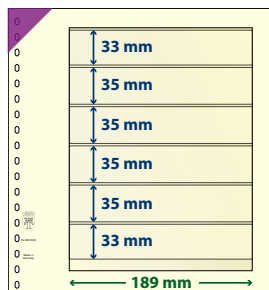

dt802606P (Pack of 5)  
Matching inserts for write-ups: A

## 7 POCKETS

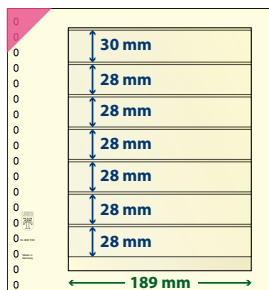

dt802700P (Pack of 5)  
Matching inserts for write-ups: A

## 8 POCKETS

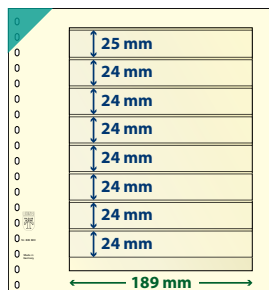

dt802800P (Pack of 5)  
Matching inserts for write-ups: A

Format: 272 x 296 mm  
Paper weight: 200 g / sqm

Made in Germany

PACK OF 5

€ 31.50

## EXHIBITION PROTECTORS

Made from a crystal clear, acid and softener free hard-PVC-foil.

### 18-ring perforation



Fits all LINDNER pages in the size of 272 x 296 mm (802-802do) Opens on the perforated side.	880	880P
Fits all A4 size pages 210 x 297 mm (805-805o) Opens on the perforated side.	8804	8804P
Fits all A4 size pages 210 x 297 mm (805-805o)	---	8805-18-1
	€ 3.50	€ 19.50

### 4-ring perforation (UNIVERSAL)



Fits all A4 size pages 210 x 297 mm (805-805o)	8805-1	8805*
* same as 8805-1 but made from a thinner softener-free PP-foil	€ 19.50	€ 33.00

## INSERTS FOR WRITE-UPS

The "write-up" sheet is placed between the hard-PVC-foil sleeve and the album page. They are available in black or white. The black sheets are designed for collectors who prefer to have a black background behind the stamps. The contrast enhances perforations, colour, and the beauty of the featured stamps. The white sheets can be used to add any text, pictures or illustrations to the sheet and can be exchanged at any time.

A	B	C	D	E
<b>Format:</b> 249 x 183 mm	<b>Format:</b> 249 x 215 mm	<b>Format:</b> 249 x 228 mm	<b>Format:</b> 296 x 231 mm	<b>Format:</b> 296 x 242 mm
○ 802001 ● 802002	○ 802013 ● 802014	○ 802015 ● 802016	○ 802017 ● 802018	○ 802011 ● 802012
Pack of 100 € 18.50	Pack of 100 € 18.50	Pack of 100 € 18.50	Pack of 100 € 18.50	Pack of 100 € 18.50



# BLANK-PAGES

LINDNER Blank-pages are offered in many different styles and colours. Collectors can create a customized collection since it is so easy to label, print, colour, glue or cut the durable cardboard pages. The pages are made of our special PERMAPHIL®-cardboard: It is acid-free, neutrally bonded and

natural and absolutely age-resistant. The Blank-pages in A4 Format can be used with PC, Laser, ink jet printer, as well as, old-fashioned typewriters to create descriptions and write-ups.

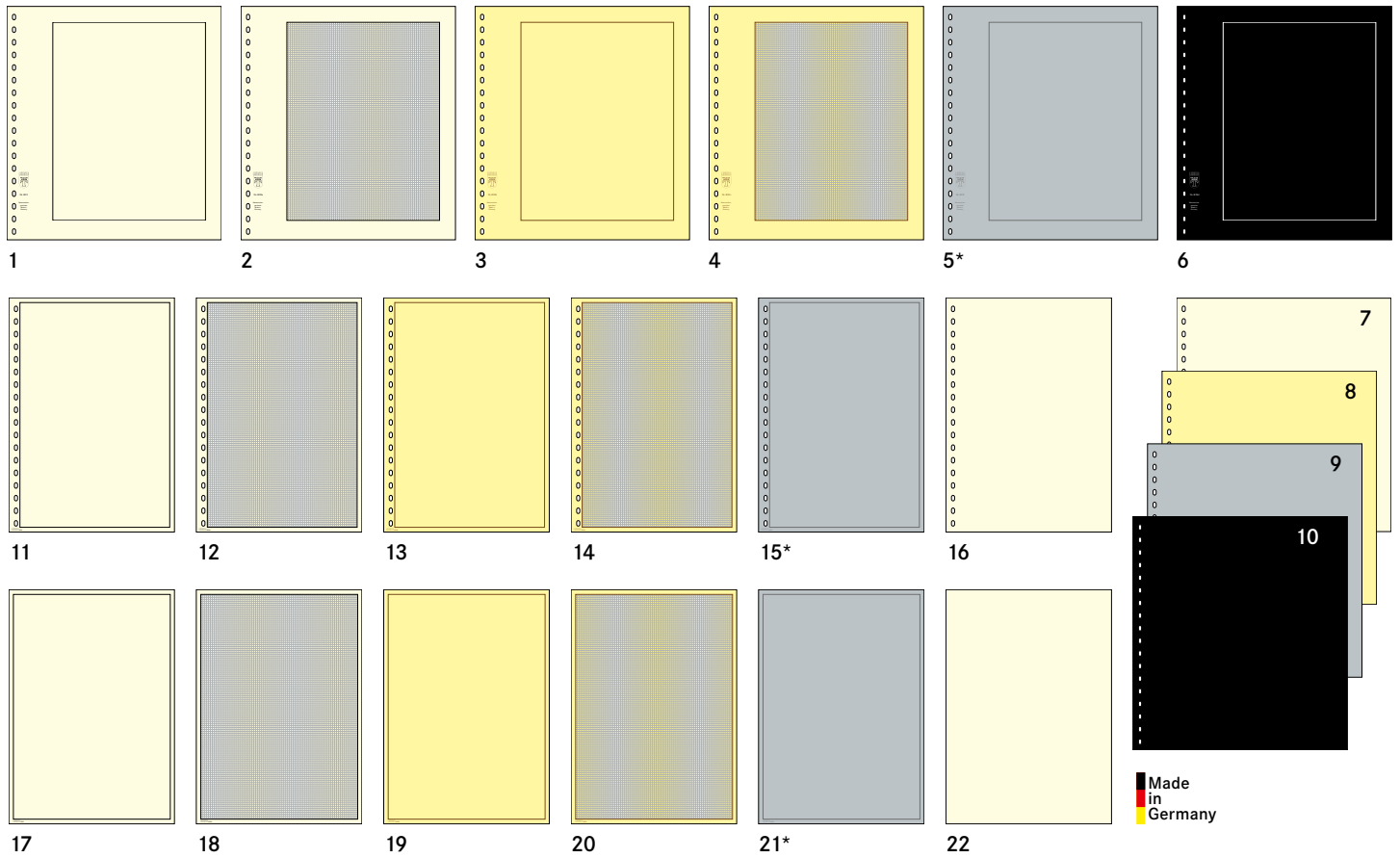

With 18-ring perforation Size: 272 x 296 mm; matching crystal clear pocket page 880.			Paper strength	
1	802	White page, Black border (193 x 251 mm)	200 g/qm	€ 12.50
2	802a	White page, Black border (193 x 251 mm), Grey border		
3	802b	Yellow page, Brown border (193 x 251 mm)	160 g/qm	
4	802c	Yellow page, Brown border (193 x 251 mm), Quadrille ruling	170 g/qm	
5	802i*	Silver-grey page, Grey border (193 x 251 mm)	200 g/qm	
6	802d	Black page, White border (193 x 251 mm)	200 g/qm	
7	802o	White page, plain	160 g/qm	
8	802bo	Yellow page, plain	170 g/qm	
9	802io*	Silver-grey page, plain	200 g/qm	
10	802do	Black page, plain		

With 18-ring perforation Size: DIN A4 (210 x 297 mm); matching crystal clear pocket page 8804.				
11	804	White page, Black border (190 x 285 mm)	170 g/qm	€ 12.50
12	804a	White page, Grey border, Black border (190 x 285 mm)		
13	804b	Yellow page, Brown border (190 x 285 mm)	160 g/qm	
14	804c	Yellow page, Brown border (190 x 285 mm), Quadrille ruling	170 g/qm	
15	804i*	Silver-grey page, Grey border (190 x 285 mm)		
16	804o	White page, plain		

Without holes Size: DIN A4 210 x 297 mm; matching crystal clear pocket pages 8805-18-1, 8805-1, 8805.				
17	805	White page, Black border (199 x 286 mm)	170 g/qm	€ 12.50
18	805a	White page, Grey border, Black border (199 x 286 mm)		
19	805b	Yellow page, Brown border (199 x 286 mm)	160 g/qm	
20	805c	Yellow page, Brown border (199 x 286 mm), Quadrille ruling	170 g/qm	
21	805i*	Silver-grey page, Grey border (199 x 286 mm)		
22	805o	White page, plain		

Exhibition protectors see page 64. Fitting ring binders are found on page 72-74.

# LINDNER T-FREESTYLE FOIL SHEETS

Design your own individual collection with all advantages of our LINDNER T-system.

Our popular LINDNER T-Blank page foil sheets, with self-adhesive strip on the left side!

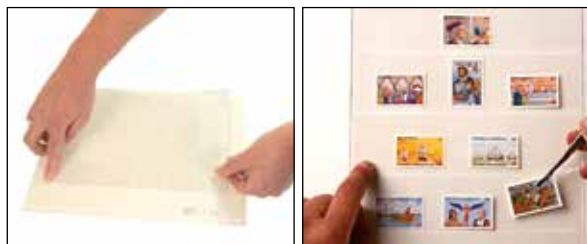
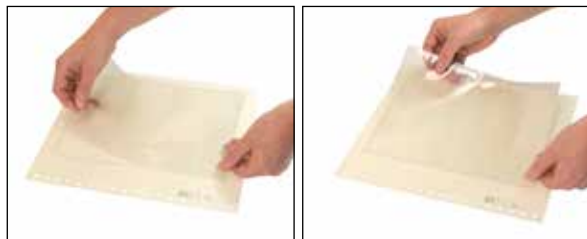
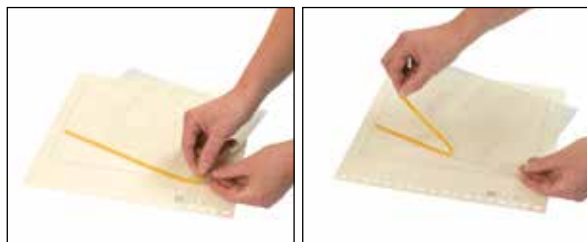
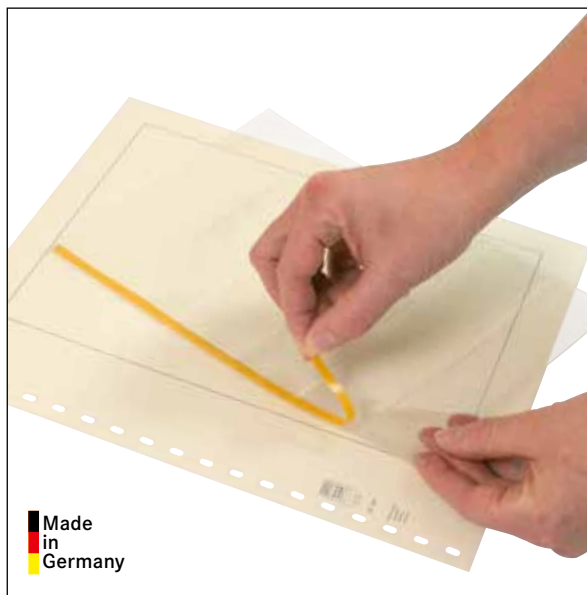

1. Determine the exact position for the foil on your sheet.
2. Remove the protective strip from the adhesive on the back of the foil.
3. Place the foil at the previously determined position and press it firmly to the album page.

**Format:** 250 x 193 mm

**Maximum width of content:** 189 mm

The practical freestyle-foil sleeves are now also in protective sleeve format available – see page 93.



**S802107H**  
(Pack of 5)

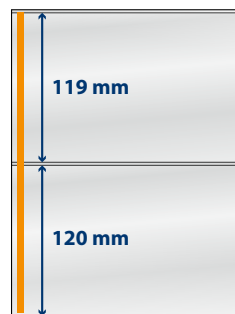

**S802204H**  
(Pack of 5)

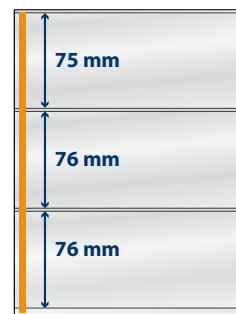

**S802310H**  
(Pack of 5)

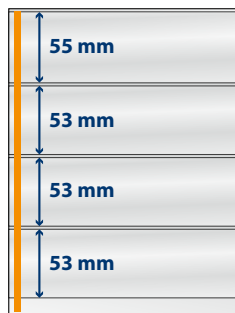

**S802408H**  
(Pack of 5)



**S802512H**  
(Pack of 5)

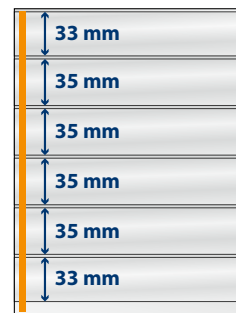

**S802606H**  
(Pack of 5)



**S802700H**  
(Pack of 5)



**S802800H**  
(Pack of 5)

The LINDNER-T foil sheets are acid- and softener-free.

PACK OF 5

€ 16.00

Made in Germany

### Protection on both sides of the stamp. Clear view of the stamp.

Stamps can be viewed by turning the page (they don't have to be removed from the protective sheet).

Secure fixture of the stamps by gentle clamping effect of the foil seams.

LINDNER T-freestyle can be integrated into each available collection-system. This offers the possibility to complete or expand an existing collection, regardless of which type of collection system is being used.

Choose the page format and position.

Layout the pages as you require, then affix the LINDNER T-freestyle foil sheet.

For an even more flexible collection-system, use the LINDNER inserts for write ups. Layout the labeling sheets as you require and then place them between the foil sheet and the album page. This offers the advantage of being able to remove the labeling sheet and re-use the album page.

Inserts for write-ups see page 64 and Blank-pages see page 65.

# ACCESSORIES FOR CUSTOM PAGE DESIGN

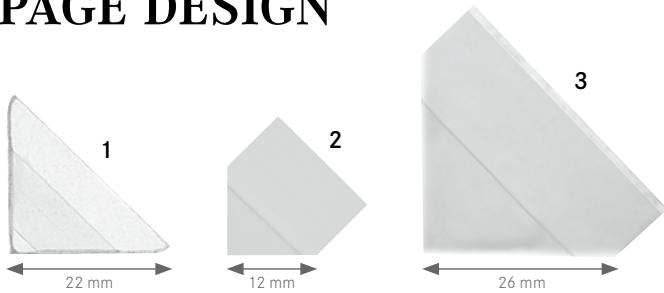

## SELF-ADHESIVE CORNER MOUNTS

These self-adhesive corner mounts are the perfect little helpers! Photos, envelopes, postcards and other collectibles can be securely positioned.

1	🛒 802019	Pack of 250	€ 11.50
2	🛒 802029	Pack of 600, backing made out of paper.	€ 17.50
3	🛒 802039	Pack of 100, transparent, extra large corner mounts to hold large photos, postal stationery and FDC's.	€ 19.50

## PRE-FOLDED STAMP HINGES

Stamp hinges are ready to use – prefolded with acid free gum.

- 🛒 7040 Pack of 1000 € 7.50
- 🛒 7041 50 packages of 1000 € 219.50



## INDICATOR DECALS

For indicating errors or varieties etc. in your collection.

Colour: red. Arrows, self-adhesive.

- 🛒 802020 Pack of 100 € 11.50



## ROTARY CUTTER

- Cutting length max. 330 mm (A4+)
- Cutter with stable metal table  
Table size (overall dimensions) 440 x 190 mm
- Helpful format lines on the base to align the material to be cut
- The transparent paper clip prevents slipping of the paper. The sturdy guide rail for the cutting head guarantees a clean and straight cut.
- Weight 1.0 kg
- Cuts up to 10 sheets at once.

**Format:** 440 x 190 x 70 mm  
**Material:** Metal

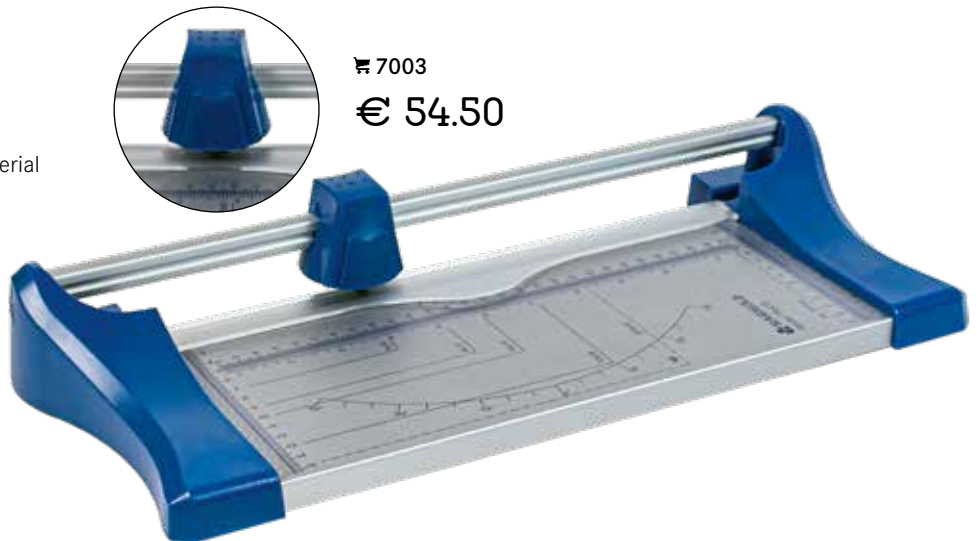

🛒 7003  
€ 54.50

## ADVANTAGE OFFER: COMPANION SET: RING BINDER REGULAR WITH SLIPCASE (1124) INCL. 20 OMNIA- PAGES OF YOUR CHOICE

### Scope of Delivery:

Ring binder and slipcase,  
20 Omnia-pages (2x packs of 10) of your choice.

Stockpages Omnia see page 70.

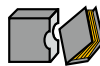

- 🛒 1124Omnia - G
  - 🛒 1124Omnia - S
  - 🛒 1124Omnia - B
  - 🛒 1124Omnia - H
  - 🛒 1124Omnia - W
- € 129.00



Made in Germany

# ASSORTMENT OF PROTECTIVE MOUNTS

The thin and extremely stable protective mount is made of softener-free PVC-foil. It consists out of one basic-foil with a gumming and one crystal clear cover-foil. For affixing the mounts you only have to moisten them at the bottom side.

Partial, there are still remainders of products that are no longer listed. We sell these products as long as stock lasts.

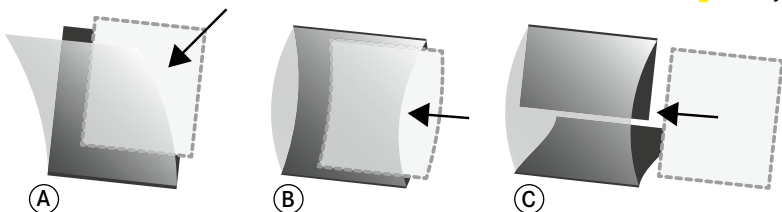

## CLAMPING POCKET:

Clamping pocket with a gummed basic-foil for inserting stamps from the top or the side. For stamps with exceptional formats, you can cut the pockets into the needed format.

## DOUBLE WELDED SEAM:

Closed at the bottom and the top, with a gummed basic-foil. For inserting the stamps from the side.

## KLEMMFIX:

Closed at the bottom and the top, with a horizontal cut in the gummed basic-foil. Guaranteed non-slip hold of the stamps.

## STRIPS

Stamp size Width x Height	🛒 black	🛒 crystal clear	Packaging unit
<b>SUPER LONG (SL) STRIPS (265 mm) ®</b> double welded = closed at the bottom and the top			
			<b>€ 10.50</b>
265 x 80 mm	HA12080	HA22080	10
265 x 85 mm	HA12085	HA22085	10
265 x 90 mm	HA12090	HA22090	10
265 x 95 mm	HA12095	HA22095	10
265 x 100 mm	HA12100	HA22100	10
265 x 105 mm	HA12105	HA22105	8
265 x 110 mm	HA12110	HA22110	8
265 x 115 mm	HA12115	HA22115	8
265 x 120 mm	HA12120	HA22120	8
265 x 125 mm	HA12125	HA22125	8
265 x 130 mm	HA12130	HA22130	7
265 x 135 mm	HA12135	HA22135	7
265 x 140 mm	HA12140	HA22140	7
265 x 145 mm	HA12145	HA22145	7
265 x 150 mm	HA12150	HA22150	7
265 x 155 mm	HA12155	HA22155	6
265 x 160 mm	HA12160	HA22160	6

## STRIPS

Stamp size Width x Height	🛒 black	🛒 crystal clear
<b>STRIPS A</b> 25 pieces, colour of packing: yellow		
<b>€ 8.50</b>		
210 x 21 mm	HA1021	HA2021
210 x 24 mm	HA1024	HA2024
210 x 25 mm	HA1025	HA2025
210 x 26 mm	HA1026	HA2026
210 x 27,5 mm	HA1027	HA2027
210 x 29 mm	HA1029	HA2029
210 x 30 mm	HA1030	HA2030
210 x 31 mm	HA1031	HA2031
210 x 32 mm	HA1032	HA2032
210 x 33 mm	HA1033	HA2033
210 x 34 mm	HA1034	HA2034
<b>STRIPS A</b> 25 pieces, colour of packing: green		
<b>€ 10.50</b>		
210 x 35 mm	HA1035	HA2035
210 x 36 mm	HA1036	HA2036
210 x 37 mm	HA1037	HA2037
210 x 39 mm	HA1039	HA2039
210 x 40 mm	HA1040	HA2040
210 x 41 mm	HA1041	HA2041
210 x 43 mm	HA1043	HA2043
210 x 44 mm	HA1044	HA2044
210 x 48 mm	HA1048	HA2048
210 x 49 mm	HA1049	HA2049
210 x 52 mm	HA1052	HA2052
210 x 53 mm	HA1053	HA2053
210 x 55 mm	HA1055	HA2055

Stamp size Width x Height	🛒 black	🛒 crystal clear
<b>STRIPS B</b> double welded = closed at the bottom and the top 10 pieces, colour of packing: white		
<b>€ 8.50</b>		
210 x 58 mm	HA1058	HA2058
210 x 60 mm	HA1060	HA2060
210 x 64 mm	HA1064	HA2064
210 x 66 mm	HA1066	HA2066
210 x 68 mm	HA1068	HA2068
210 x 70 mm	HA1070	HA2070
210 x 72 mm	HA1072	HA2072
210 x 75 mm	HA1075	HA2075
210 x 78 mm	HA1078	HA2078
210 x 82 mm	HA1082	HA2082
210 x 86 mm	HA1086	HA2086

Width x Height	🛒 black	🛒 crystal clear
<b>KLEMMFIX STRIPS FOR COIL STRIPS C</b> Klemmfix system = closed at the bottom and the top, with a horizontal cut in the basic-foil		
<b>€ 8.50</b>		
25 pieces 255 x 22 mm	HA1320	HA2320
20 pieces 385 x 22 mm	HA1321	HA2321
<b>KLEMMFIX STRIPS C</b> Klemmfix system = closed at the bottom and the top, with a horizontal cut in the basic-foil 22 pieces, colour of packing: beige		
<b>€ 8.50</b>		
210 x 21 mm	HA4021	HA3021
210 x 22 mm	HA4022	HA3022
210 x 24 mm	HA4024	HA3024
210 x 25 mm	HA4025	HA3025
210 x 26 mm	HA4026	HA3026
210 x 27 mm	HA4027	HA3027
210 x 29 mm	HA4029	HA3029
210 x 30 mm	HA4030	HA3030
210 x 31 mm	HA4031	HA3031
210 x 32 mm	HA4032	HA3032
210 x 33 mm	HA4033	HA3033
210 x 34 mm	HA4034	HA3034
<b>KLEMMFIX STRIPS C</b> Klemmfix system = closed at the bottom and the top, with a horizontal cut in the basic-foil 15 pieces, colour of packing: beige		
<b>€ 8.50</b>		
210 x 35 mm	HA4035	HA3035
210 x 36 mm	HA4036	HA3036
210 x 39 mm	HA4039	HA3039
210 x 40 mm	HA4040	HA3040
210 x 41 mm	HA4041	HA3041
210 x 42 mm	HA4042	HA3042
210 x 43 mm	HA4043	HA3043
210 x 44 mm	HA4044	HA3044
210 x 45 mm	HA4045	HA3045
210 x 48 mm	HA4048	HA3048
210 x 49 mm	HA4049	HA3049
210 x 52 mm	HA4052	HA3052
210 x 53 mm	HA4053	HA3053
210 x 55 mm	HA4055	HA3055

## BLOCK SIZES

Stamp size Width x Height	🛒 black	🛒 crystal clear	Packaging unit	Price
<b>BLOCK SIZES B</b> double welded = closed at the bottom and the top				
130 x 85 mm	HA1201	HA2201	10	€ 8.50
135 x 143 mm	HA1135143	-----	10	€ 10.50
148 x 105 mm (DIN A6)	HA1202	HA2202	10	€ 8.50
148 x 210 mm (DIN A5)	HA1206	HA2206	6	
160 x 120 mm	HA1203	HA2203	10	
210 x 170 mm	HA1204	HA2204	3	€ 16.00
245 x 185 mm	HA1245185	-----	6	
<b>A4 large blocks, with double weld</b>				
297 x 210 mm (DIN A4)	HA1318	HA2318	5	€ 16.00

Width x Height	Stamp size Width x Height	🛒 black	🛒 crystal clear	Packaging unit
<b>KLEMMFIX BLOCK SIZES C</b> for mint sheets of 10 pieces Klemmfix system = closed at the bottom and the top, with a horizontal cut in the basic-foil				
<b>€ 8.50</b>				
115 x 164 mm	46 x 27,5 mm	HA1237	HA2237	8
129 x 90 mm	21,5 x 30,5 mm	HA1239	HA2239	8
138 x 82 mm	23 x 27,5 mm	HA1231	HA2231	13
153 x 68 mm	21,5 x 26 mm	HA1230	HA2230	13
156 x 111 mm	43 x 26 mm	HA1234	HA2234	8
156 x 116 mm	43 x 26 mm	-----	HA2235	8
165 x 99 mm	27,5 x 33 mm	HA1232	HA2232	8
196 x 138 mm	33 x 55 mm	HA1236	HA2236	5
198 x 83 mm	33 x 27,5 mm	HA1233	HA2233	8
210 x 105 mm	35 x 35 mm	HA1238	HA2238	6

Stamp size Width x Height	🛒 black	🛒 crystal clear	Packaging unit
<b>KLEMMFIX BLOCK SIZES C</b> Klemmfix system = closed at the bottom and the top, with a horizontal cut in the basic-foil			
<b>€ 8.50</b>			
162 x 115 mm	HA1211	HA2211	10
165 x 95 mm	HA1210	HA2210	10
197 x 197 mm	HA1216	HA2216	4
230 x 162 mm	HA1217	HA2217	4
237 x 154 mm	HA1215	HA2215	4

## CUTS

Stamp size Width x Height	🛒 (A) black	🛒 (A) crystal clear	🛒 (C) black
<b>CUTS (A)</b> 50 pieces, colour of packing: blue			
			<b>€ 4.40</b>
19 x 22 mm	HA61922	HA71922	-----
20 x 24 mm	HA6013	HA7013	HA20024
20 x 26 mm	HA6023	HA7023	HA20026
21 x 24 mm	HA6014	HA7014	-----
<b>21,5 x 26 mm</b>	<b>HA6024</b>	<b>HA7024</b>	-----
21,5 x 30 mm	HA6043	HA7043	-----
22 x 26 mm	HA6021	HA7021	-----
22 x 31 mm	HA62231	HA72231	-----
23 x 26 mm	HA6022	HA7022	-----
<b>23 x 27,5 mm</b>	<b>HA6032</b>	<b>HA7032</b>	-----
24 x 20 mm	HA6004	HA7004	-----
24 x 21 mm	HA6007	HA7007	-----
24 x 29 mm	HA6037	HA7037	-----
24 x 40 mm	HA6056	HA7056	-----
25 x 30 mm	HA6040	HA7040	-----
25 x 36 mm	HA6085	HA7085	-----
26 x 20 mm	HA6005	HA7005	-----
<b>26 x 21,5 mm</b>	<b>HA6010</b>	<b>HA7010</b>	-----
26 x 31 mm	HA6047	HA7047	-----
26 x 36 mm	HA6051	HA7051	-----
26 x 40 mm	HA6057	HA7057	-----
26 x 41 mm	HA6061	HA7061	-----
<b>26 x 43 mm</b>	<b>HA6064</b>	<b>HA7064</b>	-----
<b>27,5 x 33 mm</b>	<b>HA6050</b>	<b>HA7050</b>	-----
28 x 34 mm	HA6049	HA7049	-----
28 x 39 mm	HA6052	HA7052	-----
29 x 24 mm	HA6015	HA7015	-----
29 x 36 mm	HA6058	HA7058	-----
30 x 36 mm	HA6059	HA7059	-----
30 x 39 mm	HA6053	HA7053	-----
31 x 24 mm	HA6016	HA7016	-----
31 x 26 mm	HA6025	HA7025	-----
31 x 32 mm	HA6031	HA7031	-----
<b>33 x 27,5 mm</b>	<b>HA6033</b>	<b>HA7033</b>	-----
34 x 28 mm	HA6036	HA7036	-----
36 x 25 mm	HA6084	HA7084	-----
36 x 26 mm	HA6026	HA7026	-----
36 x 29 mm	HA6038	HA7038	-----
36 x 30 mm	HA6041	HA7041	-----
39 x 23 mm	HA63923	HA73923	-----
39 x 28 mm	HA6035	HA7035	-----
39 x 30 mm	HA6042	HA7042	-----
40 x 24 mm	HA6020	HA7020	-----
40 x 26 mm	HA6027	HA7027	HA40026
41 x 24 mm	HA6017	HA7017	-----
41 x 26 mm	HA6028	HA7028	-----
<b>43 x 26 mm</b>	<b>HA6029</b>	<b>HA7029</b>	-----
44 x 26 mm	HA64426	HA74426	-----
<b>CUTS (A)</b> 50 pieces, colour of packing: red			
			<b>€ 5.50</b>
30 x 41 mm	HA6113	HA7113	HA30041
32 x 53 mm	-----	-----	HA32053
33 x 39 mm	HA63339	HA73339	-----
<b>33 x 55 mm</b>	<b>HA6124</b>	<b>HA7124</b>	-----
<b>35 x 35 mm</b>	<b>HA6109</b>	<b>HA7109</b>	-----
40 x 33 mm	HA6108	HA7108	-----
41 x 30 mm	HA6101	HA7101	-----
<b>41 x 41 mm</b>	<b>HA6116</b>	<b>HA7116</b>	-----
41 x 53 mm	HA6121	HA7121	HA41053
<b>46 x 27,5 mm</b>	<b>HA6100</b>	<b>HA7100</b>	-----
53 x 32 mm	-----	-----	HA53032
53 x 41 mm	HA6115	HA7115	HA53041
<b>55 x 33 mm</b>	<b>HA6105</b>	<b>HA7105</b>	-----

## MOUNTS KILOWARE: 1<sup>ST</sup> QUALITY

Mounts made of 100 % Polystyrol with black and crystal clear background are well-known to collectors all over the world due to their top quality. For affixing the mounts you only have to moisten them at the bottom side. Available in packs of 200 g, 500 g and 1000 g you also find mounts for blocks. All strips included in the packs have a length of 210 mm and can be cut into the desired width.

Special production from 1000 g.

Mixed strips	🛒 black	🛒 crystal clear	Price
50 g	S10050	W10050	€ 12.50
100 g	S10100	W10100	€ 18.00
200 g	S10200	W10200	€ 29.50
500 g	S10500	W10500	€ 64.50
1000 g	S11000	W11000	€ 107.50



## GUILLOTINE

### Guillotine cutting machine

- Cutting length max. 150 mm
- Transparent hold-down device and measuring scales in cm and inches on both sides
- Strong, ground knife with screwed stainless steel cutting surface
- Can be used creatively and is particularly easy to use
- Suitable for paper, foil and thin cardboard

Format: 140 x 195 x 30 mm



### Compact guillotine with sturdy solid metal table and non-slip rubber feet for firm standing

- Cutting length max. 320 mm
- Table size (overall dimensions) 420 x 175 mm
- Helpful format lines on the base make aligning the material to be cut easier
- Manual clamping for holding down the material being cut
- Weight 1,66 kg
- Cuts up to 8 sheets at once.

Format: 565 x 190 x 50 mm



# STOCKPAGES OMNIA

Stockpages Omnia with crystal clear strips on both sides offers a maximum of variants for collectors who like to collect a lot on one page. The different variety pages can be filled from both sides. The maximum width of the strips is 245 mm. The Stockpages Omnia (Format: 272 x 296 mm) are made of a hard-PVC-foil, free of acid and chemical softener. They are available in

black or white. They fit in all LINDNER ring binders with 18-ring perforation (Order no. 1104, 1102L, 1102Y, 1120, SRS and 1100).

Base film: black/white 300 my, Transparent strips: 100 my

● **Stockpages Omnia black**

○ **Stockpages Omnia white**



1 strip  
Pocket height  
293 mm

● **01** € 6.50  
○ **09** € 6.50

Pack of 10:

● **01P** € 36.50  
○ **09P** € 36.50



2 strips  
Pocket height  
140 mm

● **02** € 6.50  
○ **10** € 6.50

Pack of 10:

● **02P** € 36.50  
○ **10P** € 36.50



3 strips  
Pocket height  
91 mm

● **03** € 6.50  
○ **11** € 6.50

Pack of 10:

● **03P** € 36.50  
○ **11P** € 36.50



4 strips  
Pocket height  
67 mm

● **04** € 6.50  
○ **12** € 6.50

Pack of 10:

● **04P** € 36.50  
○ **12P** € 36.50



5 strips  
Pocket height  
52 mm

● **05** € 6.50  
○ **13** € 6.50

Pack of 10:

● **05P** € 36.50  
○ **13P** € 36.50



6 strips  
Pocket height  
43 mm

● **06** € 6.50  
○ **14** € 6.50

Pack of 10:

● **06P** € 36.50  
○ **14P** € 36.50



7 strips  
Pocket height  
34 mm

● **07** € 6.50  
○ **15** € 6.50

Pack of 10:

● **07P** € 36.50  
○ **15P** € 36.50



8 strips  
Pocket height  
30 mm

● **08** € 6.50  
○ **16** € 6.50

Pack of 10:

● **08P** € 36.50  
○ **16P** € 36.50



4 strips  
Pocket height  
3x 43 and 1x 141 mm

● **081** € 6.50  
○ **0161** € 6.50

Pack of 10:

● **081P** € 36.50  
○ **0161P** € 36.50



4 vertical and 6 horizontal  
pockets  
Pocket height  
95 x 143 mm  
Suited for  
10 old postcards

● **021** € 6.50

Pack of 10:

● **021P** € 36.50



Mint Sheet Page /  
Larger page format  
Suited for 2 Mint Sheets  
262 x 305 mm

The double-sided, black page  
holds 2 sheets up to the size  
of 262 x 305 mm.

● **020** € 6.50

Pack of 10:

● **020P** € 36.50



8 pockets  
Pocket height  
120 x 66 mm

Suited for approval cards

● **040** € 6.50  
○ **030** € 6.50

Pack of 10:

● **040P** € 36.50  
○ **030P** € 36.50



Approval Cards

Format: 115 x 66 mm

1 strip  
Pack of 100

● **031** € 23.50

2 strips  
Pack of 100

● **032** € 23.50

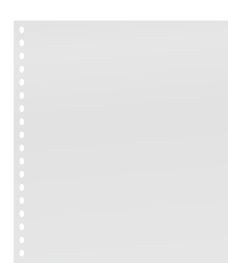

Protective interleaving

Suited for Omnia-, Blank-  
and dT-Blank-pages.  
Material: Plastothen, free  
of chemical softeners.

Pack of 20

₹ **800** € 14.00

Pages 100% free  
from chemical  
softeners.

Made  
in  
Germany

Save money with the Omnia-advantage offer, see page 67.

# CRYSTAL CLEAR POCKET PAGES

## SELECTION – OPTIONS – ALTERNATIVES!

It is important for LINDNER to offer a wide selection of pages which offer a large variety of different uses. It is a commitment that we take seriously! Large or small, horizontal or vertical, strips or booklets – LINDNER always provides a large selection and countless options. Our crystal clear pocket

pages are made of an acid and softener-free, crystal clear hard-PVC-foil. Pages fit in all 18-ring binders (Order no. 1104, 1102L, 1102Y, 1120, SRS) and in ECO (Order no. 1100).



1 large pocket <sup>1)</sup>  
240 x 290 mm  
crystal clear, with black inserts  
● 820 € 5.00  
Pack of 10:  
● 820P € 28.00



2 pockets <sup>1)</sup>  
240 x 140 mm  
crystal clear, with black inserts  
● 821 € 5.00  
Pack of 10:  
● 821P € 28.00



3 pockets <sup>1)</sup>  
240 x 90 mm  
crystal clear, with black inserts  
● 822 € 5.00  
Pack of 10:  
● 822P € 28.00



3 horizontal strips <sup>2)</sup>  
242 x 90 mm  
crystal clear, incl. black backing page  
● 823 € 6.50  
Pack of 10:  
● 823P € 36.50



4 horizontal strips <sup>2)</sup>  
242 x 65 mm  
crystal clear, incl. black backing page  
● 824 € 6.50  
Pack of 10:  
● 824P € 36.50



5 horizontal strips <sup>2)</sup>  
242 x 50 mm  
crystal clear, incl. black backing page  
● 825 € 6.50  
Pack of 10:  
● 825P € 36.50



10 pockets <sup>2)</sup>  
120 x 53 mm  
crystal clear, incl. black backing page  
● 725 € 6.50  
Pack of 10:  
● 725P € 36.50



8 horizontal strips <sup>2)</sup>  
242 x 30 mm  
crystal clear, incl. black backing page  
● 828 € 6.50  
Pack of 10:  
● 828P € 36.50

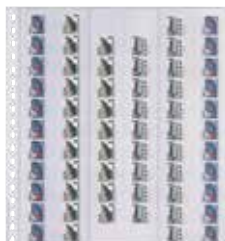

6 vertical strips <sup>2)</sup>  
36 x 296 mm  
crystal clear, incl. black backing page  
● 849 € 8.50  
Pack of 10:  
● 849P € 55.50

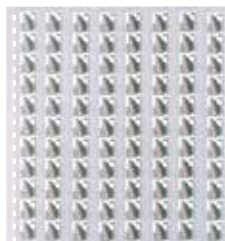

8 vertical strips <sup>1)</sup>  
28 x 296 mm  
crystal clear, incl. black backing page  
● 848 € 8.50  
Pack of 10:  
● 848P € 55.50

<sup>1)</sup> thin basic-foil  
<sup>2)</sup> thick basic-foil

Pages 100% free from chemical softeners.

Made in Germany

## CRYSTAL CLEAR POSTCARD-PAGES



2 vertical and 3 horizontal pockets <sup>2)</sup>  
95 x 143 mm  
Suited for 5 (10) old postcards  
crystal clear, incl. black backing page  
● 826 € 6.50  
Pack of 10:  
● 826P € 36.50



4 vertical pockets <sup>2)</sup>  
114 x 146 mm  
Suited for 4 (8) modern postcards  
crystal clear, incl. black backing page  
● 829 € 6.50  
Pack of 10:  
● 829P € 36.50



1 pocket <sup>1)</sup>  
240 x 290 mm  
Suited for Share certificate, banknote  
crystal clear, incl. black backing page  
● 853 € 5.00  
Pack of 10:  
● 853P € 28.00

crystal clear, incl. white backing page  
● 833 € 5.00  
Pack of 10:  
● 833P € 28.00



2 pockets <sup>1)</sup>  
240 x 140 mm  
Suited for Booklets, banknotes  
crystal clear, incl. black backing page  
● 850 € 5.00  
Pack of 10:  
● 850P € 28.00

crystal clear, incl. white backing page  
● 830 € 5.00  
Pack of 10:  
● 830P € 28.00



3 pockets <sup>1)</sup>  
240 x 90 mm  
Suited for Booklets, banknote protective covers 897LP  
crystal clear, incl. black backing page  
● 851 € 5.00  
Pack of 10:  
● 851P € 28.00

crystal clear, incl. white backing page  
● 831 € 5.00  
Pack of 10:  
● 831P € 28.00



4 pockets <sup>1)</sup>  
240 x 65 mm  
Suited for Booklets, banknotes  
crystal clear, incl. black backing page  
● 852 € 5.00  
Pack of 10:  
● 852P € 28.00

crystal clear, incl. white backing page  
● 832 € 5.00  
Pack of 10:  
● 832P € 28.00

# RING BINDER FOR LINDNER PAGE FORMATS

Tested and sold hundreds of thousands of times and preferred by many stamp collectors. Our LINDNER ring binders represent quality, appearance and functionality. All ring binders are superbly manufactured and guarantee

convenient handling when turning pages. Removing or adding pages is especially easy - simply press the tabs on the top and bottom to open the 18-ring mechanism. Page lifters ensure that the pages lie flat at all times.



## RING BINDER REGULAR

The deep, grainy leatherette material gives this ring binder an attractive appearance. The padded binder is equipped with: cover sheets, page lifters and an index window on the spine for identification purposes.

Slipcase for ring binder Regular (Order no. 1104), welded, in matching colour and special feature: cut out for easily removing of the ring binder.

**Format Ring binder:** 305 x 317 x 50 mm

**Format Ring binder incl. Slipcase:** 310 x 325 x 60 mm

**Mechanism:** 18-ring

🛒 1124 - G	🛒 1104 - G	🛒 814 - G
🛒 1124 - S	🛒 1104 - S	🛒 814 - S
🛒 1124 - B	🛒 1104 - B	🛒 814 - B
🛒 1124 - H	🛒 1104 - H	🛒 814 - H
🛒 1124 - W	🛒 1104 - W	🛒 814 - W
€ 77.00	€ 54.00	€ 36.50



**Flags**  
see page 89



Made in Germany

## RING BINDER "STANDARD"

The "Standard" ring binder has been a firm favourite for our customers for many years. The padded ring binder is made of a smooth synthetic material called "Yorn" and is equipped with cover sheets, page lifters and an index window on the spine for identification purposes. Slipcase covered with leatherette in matching colours.

**Format Ring binder:** 305 x 317 x 50 mm

**Mechanism:** 18-ring

🛒 1122 - G	🛒 1102Y - G	🛒 810BY - G
🛒 1122 - S	🛒 1102Y - S	🛒 810BY - S
🛒 1122 - B	🛒 1102Y - B	🛒 810BY - B
🛒 1122 - H	🛒 1102Y - H	🛒 810BY - H
🛒 1122 - W	🛒 1102Y - W	🛒 810BY - W
€ 79.00	€ 58.50	€ 29.00

Made in Germany



## RING BINDER: "EXCLUSIVE LEATHER"

This padded ring binder is handmade of finest genuine leather. The exceptional quality in material and workmanship is truly impressive. Cover sheets and page lifters included.

**Format Ring binder:** 305 x 317 x 50 mm  
**Mechanism:** 18-ring



## COMPANION SET: "EXCLUSIVE"

Handmade of the finest material: The outside of our ring binder is covered with a high-quality leatherette. The rounded corners and the gold embossing on the spine and front cover give each ring binder the most luxurious appearance. Cover sheets and page lifters included. Slipcase covered with leatherette in matching colours.

**Format Ring binder:** 305 x 317 x 50 mm  
**Mechanism:** 18-ring

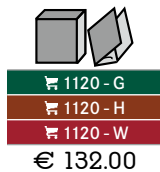

### Approximate Capacity of the LINDNER ring binder:

- 50 LINDNER T-Illustrated pages / T-Blank-pages
- 45 LINDNER dT-Illustrated pages / dT-Blank-pages
- 35 Omnia or crystal clear pages
- 60 LINDNER Blank-pages

## PAGE LIFTERS, SET OF 2

Prevents bending of the pages when closing the ring binder.

799  
€ 6.50



## SLIPCASE PULL-HANDLE

For simple removing of the ring binders from the slipcase. Simply place the pull-handle into the bottom of the slipcase.

798  
€ 6.50



## RING BINDER IN STAMP-DESIGN WITH 18-RING-MECHANISM, EMPTY

Padded LINDNER Ring binder made of synthetic-foil in stamp-design. Suitable for all pages in LINDNER page format with 18-ring hole punch.

**Format Ringbinder:** 305 x 317 x 50 mm

**Mechanism:** LINDNER 18-Ring



3702R  
€ 44.00

Made  
in  
Germany



**Capacity:**  
approx. 35-40 LINDNER Stockpages with  
18-ring hole punch.

## SLIPCASE RING BINDER ECO

The well proven LINDNER slipcase ring binder offers a lot of space for stockpages and for everything that can be stored in a ring binder. Thanks to the combination of a ring binder and a slipcase, your collection is always protected from all sides and stands safely on your shelf. The padded, grainy leatherette material offers a unique character. The slipcase ring binder ECO is available in 5 colours.

**Features:**

Filling level: 30 mm

Transparent cover sheets

2 cover sheets in corresponding colours

Index window on the spine for description and identification

**Format:** 315 x 320 x 65 mm

**Mechanism:** 4-ring, 80/80/80 mm (Standard)

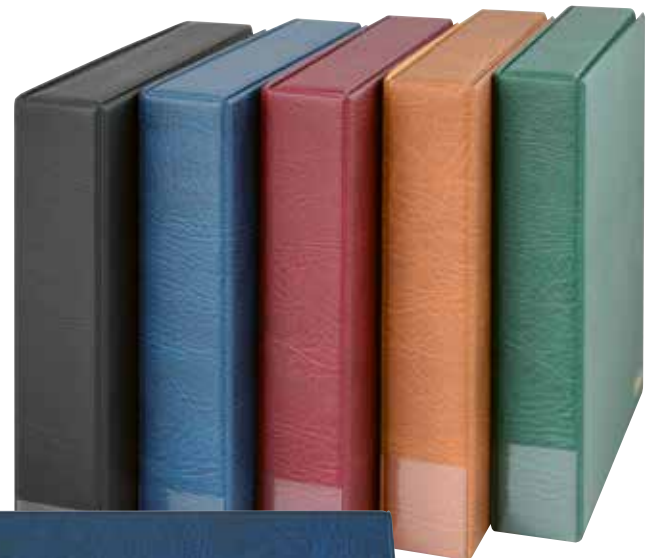

Made  
in  
Germany

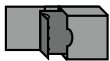

1100 - G

1100 - S

1100 - B

1100 - H

1100 - W

€ 76.50



**Capacity:**

approx. 80 LINDNER T-Illustrated pages / T-Blank-pages  
approx. 65 LINDNER dt-Illustrated pages / dt-Blank-pages  
approx. 60 Omnia pages or crystal clear pages  
approx. 90 LINDNER Blank-pages

# RING BINDER UNIVERSAL SRS

Sturdy ring binder with black cover made of padded synthetic-foil. The grained surface in a leather-effect gives this ring binder its individual character. The standard mechanism allows an universal use. Includes 2 black cover sheets.

- Easy page turning due to ring mechanism.
- Hassle-free removal or exchange of pages.
- High capacity.
- Add other page versions as you like.

**Format Ring binder:** 305 x 317 x 50 mm

**Mechanism:** 4-ring, 80/80/80 mm (Standard)

		
<b>SRS-814</b>	<b>SRS</b>	<b>814-S</b>
€ 67.00	€ 41.50	€ 36.50

Made in Germany



**Capacity:**  
approx. 40 Protective sleeves / Stockpages

This ring binder can store all pages in LINDNER page format with 18-ring hole punch.

## BANKNOTE ALBUM SRS

Ring binder with 20 crystal clear pages for banknotes, made of softener-free foil, including 20 white cardboard interleaves. 10 of the pages have 2 pockets (Order no. 830) for banknotes up to a size of 240 x 140 mm and 10 of the pages have 3 pockets (Order no. 831) for banknotes up to a size of 240 x 90 mm.

	
<b>SRSBN-814</b>	<b>SRSBN</b>
€ 90.00	€ 69.00

## POSTCARD ALBUM SRS

Ring binder with 20 crystal clear pages for postcards, made of softener-free foil (Order no. 829) as well as 20 black interleaves. The crystal clear pages have 4 vertical pockets (114 x 146 mm) for either 4 or 8 postcards if used on both sides.

	
<b>SRSPK-814</b>	<b>SRSPK</b>
€ 90.00	€ 69.00

## STOCKPAGE ALBUM SRS

Ring binder with 20 black stockpages for stamps, made of softener-free foil as well as 20 foil interleaves. The high-quality stockpages have 8 transparent strips per page (Order no. 08), can be filled on both sides and offer a neat solution for your collection.

	
<b>SRSB-814</b>	<b>SRSB</b>
€ 90.00	€ 69.00

# STOCKBOOKS



## STOCKBOOK STANDARD

Interleaving pages: double, glassine.  
Cover: leatherette, **unpadded**.  
Format: 230 x 305 mm

Pages	Glassine strips	🛒					Price	
		G	S	B	H	R		
16	regular	1160 -	G	S	B	H	R	€ 17.50
32	regular	1161 -	G	S	B	H	R	€ 27.00
64	regular	1163 -	G	S	B	H	R	€ 52.50
64	divided	1167 -	G	S	B	H	R	€ 57.50

Pages	Transparent strips	🛒					Price	
		G	S	B	H	R		
16	regular	5701 -			B		R	€ 18.50
32	regular	1168 -	G	S	B	H	R	€ 30.00
64	regular	1170 -	G	S	B	H	R	€ 52.50

## STOCKBOOK ELEGANT

Interleaving pages: double, glassine.  
Cover: leatherette, **padded**.  
Format: 230 x 305 mm

Pages	Glassine strips	🛒			Price	
		S	B	R		
64	regular	1175 -	S	B	R	€ 52.50

Pages	Transparent strips	🛒			Price	
		S	B	R		
64	regular	1179 -	S	B	R	€ 57.50



## SLIPCASE FOR ALL 64-PAGE STOCKBOOKS

Slipcase made of laminated cardboard in matching colour.  
Format: 240 x 320 mm

Slipcase, empty	116K -	G	S	B	H	R	€ 20.00
-----------------	--------	---	---	---	---	---	---------



## STAMP ALBUM WITH SCREW MECHANISM

Ring binder made of padded PVC-foil.  
Comes with 10 stockpages made of black cardboard, Linen joint.  
Format: 280 x 310 x 50 mm

Pages	Transparent strips		Price
10	regular	1190 - <b>G</b> <b>S</b> <b>B</b> <b>R</b>	€ 52.50

## STOCKPAGES

Crystal clear strips on both sides and clear cover page on the front.  
Pages with 6 hole punching. **10 pages per package.**  
Format: 265 x 290 mm

Transparent strips	Material		Price
6 regular	Card	1171F	€ 30.00

Suited for: Stamp album with screw mechanism.

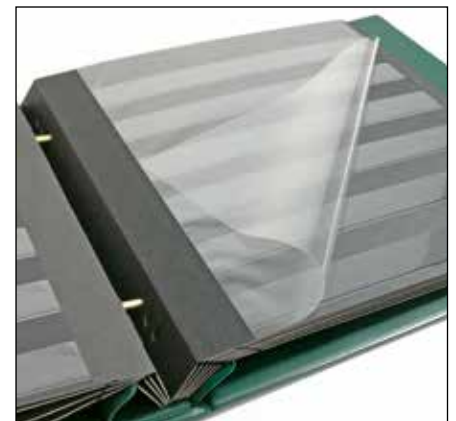

## AN INDISPENSABLE TOOL FOR EVERY STAMP COLLECTOR

**Perforation gauge**  
see page 90

**LINDNER Stampscop**  
see page 90



**Drying books**  
see page 89



**Stamp tongs**  
see page 89

**Magnifiers**  
see page 110-112



**Stamp remover**  
Stamp care, ERNI  
see page 88



# MULTI COLLECT - SYSTEM

## VERSATILE COLLECTING WITH OUR MULTI-TALENTED SYSTEM

Versatile collecting with our multi-purpose album system. This album rightly deserves its name – every collector can find a large assortment of pages with a wide variety of pocket sizes which provides different types of collections.

Whether you collect stamps, sheetlets, FDCs, ETBs, year books, booklets, postcards, banknotes, coins or phone cards: Our Multi collect-system has a place for everything! The typical 4-ring mechanism of the padded Multi collect-ring binder guarantees easy handling and impresses with a large capacity. A plastic window on the spine provides space for identification labels/description of contents.

We offer ring binders which differ in size, colour and storage capacity.

Fitting ring binders are found on page 42-43.



### BLANK PAGES

With 4-ring perforation  
Size PUBLICA M: 210 x 255 mm  
Material: 200 g/qm

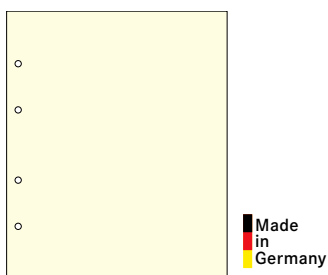

Blank pages  
210 x 255 mm

Pack of 10  
€ 803o € 12.50



1 pocket  
190 x 253 mm

Pack of 10  
● MU1311 € 12.50  
○ MU1321 € 11.50

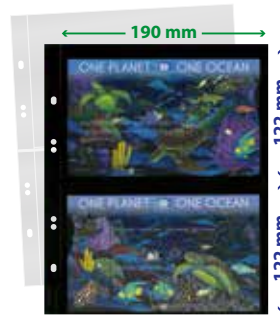

2 strips  
190 x 122 mm

Pack of 10  
● MU1312 € 12.50  
○ MU1322 € 11.50

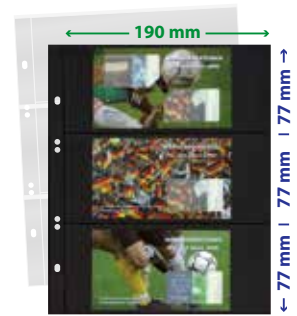

3 strips  
190 x 77 mm

Pack of 10  
● MU1313 € 12.50  
○ MU1323 € 11.50

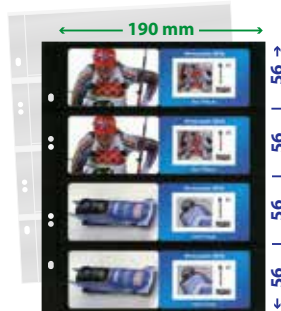

4 strips  
190 x 56 mm

Pack of 10  
● MU1314 € 12.50  
○ MU1324 € 11.50



5 strips  
190 x 43 mm

Pack of 10  
● MU1315 € 12.50  
○ MU1325 € 11.50

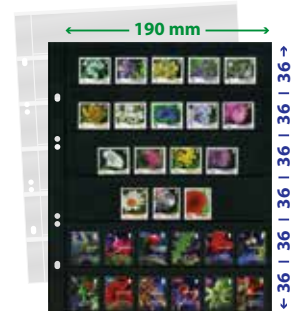

6 strips  
190 x 36 mm

Pack of 10  
● MU1316 € 12.50  
○ MU1326 € 11.50



2 vertical strips  
91 x 253 mm

Pack of 10  
● MU1317 € 12.50



1 pocket  
151 x 235 mm

Pack of 10  
● MU1330 € 12.50  
○ MU1340 € 11.50

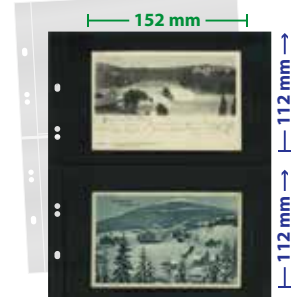

2 strips  
152 x 112 mm

Pack of 10  
● MU1331 € 12.50  
○ MU1341 € 11.50

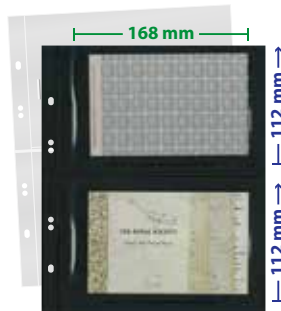

2 strips  
168 x 112 mm

Pack of 10  
● MU1332 € 12.50  
○ MU1342 € 11.50

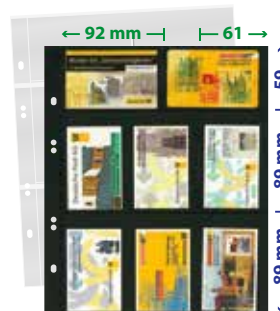

8 pockets  
92 x 59 mm (2x)  
61 x 89 mm (6x)

Pack of 10  
● MU1353 € 12.50  
○ 1363\* 2) € 11.50

\*Delivery only while stocks last. 2) Suited for Ring binder 1300 and 1400

Prices do not include contents / display material. All prices and specifications are subject to change without prior notice.



2 pockets  
175 x 123 mm  
2 sets Euro-coins Germany proof

Pack of 10  
○ MU1363 € 11.50



8 pockets  
93 x 56 mm  
Coincards, Telephone cards

Pack of 10  
○ MU1364 € 11.50



1 pocket  
180 x 207 mm  
current coin sets in blister

Pack of 10  
○ MU1392 € 11.50

## MULTI COLLECT-PAGES

The **one-sided**, crystal clear Multi collect-pages are made of softener and acid-free hard-PVC-foil. You can view the front and back of the items that are placed in these pages.

The **double-sided**, black Multi collect-pages are made of archival safe hard-PVC, that is free of acids and chemical softeners to ensure long term preservation and presentation.

Format: 210 x 255 mm



1 pocket  
185 x 250 mm  
one pocket with black insert

Pack of 10  
○ MU1405 € 12.50



2 pockets  
185 x 120 mm  
two pockets with black inserts

Pack of 10  
○ MU1404 € 12.50



3 pockets  
185 x 80 mm  
three pockets with black inserts

Pack of 10  
○ MU3103 € 12.50

## MULTI COLLECT-PAGES FOR BANKNOTES

The Multi collect-pages made of crystal-clear, softener and acid-free hard-PVC-foil with black foil insert strips can be filled twice. The foil insert strips are removable. This offers the possibility to fill the pockets with just one receipt and the front and back of the contents can be viewed.

Format: 210 x 255 mm



12 pockets Ø 50 mm

Pack of 5  
Interleaving black  
● MU12<sup>3)</sup> € 12.50  
Interleaving red  
● MU12R<sup>3)</sup> € 12.50



15 pockets Ø 42 mm

Pack of 5  
Interleaving black  
● MU15 € 12.50  
Interleaving red  
● MU15R € 12.50



24 pockets Ø 34 mm

Pack of 5  
Interleaving black  
● MU24 € 12.50  
Interleaving red  
● MU24R € 12.50

## MULTI COLLECT-COIN PAGES

Our **crystal clear Multi collect-coin pages** provide neat and safe storage of your coin collection. Simply remove the plastic strip from the page and insert the coins in the individual compartments. Once it is filled, insert the strip back into the page. The pages are easily removed, added or changed.

Format: 202 x 252 mm

<sup>3)</sup> Made in EU



35 pockets Ø 27 mm

Pack of 5  
Interleaving black  
● MU35 € 12.50  
Interleaving red  
● MU35R € 12.50

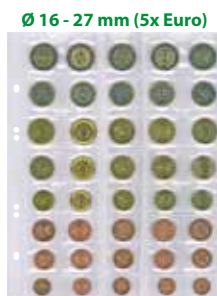

5x €-coin set

Pack of 5  
Interleaving black  
● MU40 € 12.50  
Interleaving red  
● MU40R € 12.50



54 pockets Ø 20 mm

Pack of 5  
Interleaving black  
● MU54 € 12.50  
Interleaving red  
● MU54R € 12.50

## INTERLEAVING PAGES

(Format: 210 x 255 mm)

Interleaves are recommended for interleaving purposes

Pack of 20, crystal clear  
○ MU1385 € 8.50

Interleaving black  
Pack of 5  
● MUZ € 5.00

Pack of 10  
● MU1386 € 8.50

Interleaving red  
Pack of 5  
● MUZR € 5.00

# MULTI COLLECT - RING BINDER REGULAR CLASSIC

Ring binder made of padded synthetic-foil. The grained surface in leather-effect gives the ring binder its individual character. The typical 4-ring mechanism of the Multi collect-ring binder guarantees a simple handling and the ring binder impresses with its large capacity. The generous spine window offers space for content listing.

Matching pages see page 78-79.

**Format Ring binder:** 245 x 270 x 80 mm

**Format Ring binder incl. Slipcase:** 250 x 280 x 85 mm

**Mechanism:** 4-ring, 40/80/40 mm



See our Multi Collect complete album for postcards on page 85.

Made in Germany

1302 - G	1300 - G	1301 - G
1302 - S	1300 - S	1301 - S
1302 - B	1300 - B	1301 - B
1302 - H	1300 - H	1301 - H
1302 - W	1300 - W	1301 - W
€ 51.00	€ 34.50	€ 26.00



**Capacity:**  
 approx. 20 Multi collect-coin pages  
 approx. 60 Multi collect-stockpages – black  
 approx. 80 Multi collect-stockpages – crystal clear

# RING BINDER RONDO REGULAR COMPACT

Ring binder made of padded synthetic-foil. The rounded spine and grained surface gives the ring binder its classical look. The spine window offers space for content listing.

Matching pages see page 78-79.

**Format:** 235 x 270 x 40 mm

**Format Ring binder incl. Slipcase:** 245 x 280 x 45 mm

**Mechanism:** 4-ring, 40/80/40 mm



Made in Germany



1402 - G	1400 - G	1401 - G
1402 - S	1400 - S	1401 - S
1402 - B	1400 - B	1401 - B
1402 - H	1400 - H	1401 - H
1402 - W	1400 - W	1401 - W
€ 47.50	€ 31.00	€ 24.50



See our FDC complete album "REGULAR" on page 83.

**Capacity:**  
 approx. 35 Multi collect-stockpages – black  
 approx. 50 Multi collect-stockpages – crystal clear

# RING BINDER PUBLICA M COLOR



The large capacity enhances the modern and fresh appearance of these high-quality, padded ring binders. The robust and sturdy material guarantee an extensive durability of this ring binder. The standard mechanism allows it to be used universally. A pocket on the inside of the binder offers room for content labelling. Matching pages see page 78-79.

**Format Ring binder:** 245 x 270 x 60 mm  
**Format Ring binder incl. Slipcase:** 250 x 280 x 75 mm  
**Mechanism:** 4-ring, 45/65/45 mm



Made in Germany



-  S3542 - 1
  -  S3542 - 9
  -  S3542 - 5
  -  S3542 - 4
  -  S3542 - 13
- € 41.50





**Capacity:**  
 approx. 15 Multi collect-coin pages  
 approx. 50 Multi collect-stockpages – black  
 approx. 70 Multi collect-stockpages – crystal clear



Made in Germany



Please note the PUBLICA-M album for coins (Order no. 3532M) on page 43.

			
S3532 - G	S3530 - G	S3531 - G	S3532BN - G
S3532 - S	S3530 - S	S3531 - S	S3532BN - S
S3532 - B	S3530 - B	S3531 - B	S3532BN - B
S3532 - H	S3530 - H	S3531 - H	S3532BN - H
S3532 - W	S3530 - W	S3531 - W	S3532BN - W
€ 46.00	€ 33.00	€ 21.00	€ 56.50

Prices do not include contents / display material. All prices and specifications are subject to change without prior notice.

# RING BINDER PUBLICA M

## A SPACE-SAVING, SAFE AND ATTRACTIVE RING BINDER FOR COINS AND BANKNOTES

The high-quality ring binder from the PUBLICA series offers a uniform, classical and timeless design. The sturdy construction and the quality materials selected for this ring binder guarantee many years of use. The padded leatherette cover has a 4-ring mechanism and is also available with a matching slipcase. A large, clear index window on the spine allows you to insert a description for easy identification of the contents. Matching pages see page 78-79.

The sturdy slipcase, that is optionally available, protects the album and its contents. It stands safely on the shelf or cupboard.

**Format Ring binder:** 245 x 270 x 60 mm  
**Format Ring binder incl. Slipcase:** 250 x 280 x 75 mm  
**Mechanism:** 4-ring, 45/65/45 mm

## PUBLICA M BANKNOTE ALBUM FOR UP TO 80 BANKNOTES/POSTCARDS

PUBLICA M ring binder comes with 20 crystal clear Multi collect-pages Order no. MU1404 to hold banknotes, postcards or other collectibles. The page can hold either 2 or 4 items, depending upon your preference. The pockets have black inserts which can be easily removed making both sides of the collectible visible.

# FIRMO UNIVERSAL ALBUMS

The FIRMO Universal albums made of a high-quality leatherette cover offers plenty of space for banknotes, FDC's, letters, photos, postcards etc. The crystal clear synthetic sleeves with black paper inserts are made of PVC-foil that can be used from both sides. The pages open at the inner side so that the documents are protected from dirt and falling out. The albums are carefully produced and are characterised by their plain elegance.

## FIRMO XL

With 56 crystal clear synthetic sleeves that can be used from both sides. The black paper inserts can be used as a divider.

For 224 items up to the size of 245 x 132 mm.

Format: 285 x 305 x 75 mm

🏷️ 812XL € 39.50



- 812XL-R
- 812XL-B
- 812XL-S

## FIRMO L

With 54 crystal clear synthetic sleeves that can be used from both sides. The black paper inserts can be used as a divider.

For 108 items up to the size of 245 x 132 mm.

Format: 285 x 155 x 75 mm

🏷️ 812L € 21.50



- 812L-R
- 812L-B
- 812L-S

## FIRMO

With 54 crystal clear synthetic sleeves that can be used from both sides. The black paper inserts can be used as a divider.

For 108 items up to the size of 190 x 130 mm.

Format: 230 x 155 x 75 mm

🏷️ 812 € 18.50



- 812-R
- 812-B
- 812-S

## FDC Album "small"

Padded vinyl binder to hold 100 documents up to size 190 x 125 mm thin continental type.

External measurements: 240 x 145 x 55 mm



Made in Germany

## FDC Albums "small" in long format

Padded vinyl binder to hold 100 documents up to size 240 x 125 mm thin continental type.

External measurements: 285 x 145 x 55 mm

1			2		
	🏷️ 816 - G	🏷️ 816K - G		🏷️ 817 - G	🏷️ 817K - G
	🏷️ 816 - S	🏷️ 816K - S		🏷️ 817 - S	🏷️ 817K - S
	🏷️ 816 - B	🏷️ 816K - B		🏷️ 817 - B	🏷️ 817K - B
	🏷️ 816 - R	🏷️ 816K - R		🏷️ 817 - R	🏷️ 817K - R
	€ 23.50	€ 19.00		€ 33.50	€ 22.50

### FDC ALBUM RONDO REGULAR



Ring binder made of padded synthetic-foil. The rounded spine and grained surface gives the ring binder its classical look. The spine window offers space for content listing.

Comes with 10 transparent pages with two pockets (Order no. MU1404).

**Format Ring binder:** 235 x 270 x 40 mm

**Mechanism:** 4-ring, 40/80/40 mm

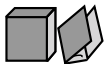
**Capacity:** approx. 35 pages

			
1403 - G	1402 - G	1400 - G	1401 - G
1403 - S	1402 - S	1400 - S	1401 - S
1403 - B	1402 - B	1400 - B	1401 - B
1403 - H	1402 - H	1400 - H	1401 - H
1403 - W	1402 - W	1400 - W	1401 - W
€ 37.00	€ 47.50	€ 31.00	€ 24.50

**Additional pages:** Pack of 10 € 12.50

☒ **MU1404** two pockets including two black inserts to hold items up to size 185 x 120 mm.

☒ **MU1405** one pocket including one black insert to hold items up to size 185 x 250 mm.



Supplement pages and a lot of suitable page variations for this ring binder you can find on page 78-79.







### ETB-ALBUM CLASSIC

Ring binder in high-quality, made of padded synthetic-foil with spine window for content labelling. Comes with 20 transparent pages size DIN A5 (Order no. 819) made of softener and acid free, transparent hard-PVC-foil.

**Format Ring binder:** 200 x 235 x 40 mm

**Mechanism:** 13-ring

**Capacity:** approx. 40 transparent pages

			
1103E - G	1130 - G	1103Y - G	810CY - G
1103E - S	1130 - S	1103Y - S	810CY - S
1103E - B	1130 - B	1103Y - B	810CY - B
1103E - W	1130 - W	1103Y - W	810CY - W
€ 47.50	€ 56.00	€ 29.50	€ 22.00

**Additional pages:** Pack of 10 € 12.50

☒ **819** One pocket: DIN A5 / 148 x 210 mm (Format: 174 x 216 mm).

### ETB-ALBUM LOTOS

First Day Sheet Album with 50 crystal clear pages which are free of any chemical softeners. Padded 4-ring binder which has gold embossed logo on front cover and spine, plus gold stripes on the spine.

**Format Ring binder:** 194 x 228 x 50 mm

**Mechanism:** 4-ring, 45/65/45 mm

**Capacity:** approx. 80 pages

5600 - G
5600 - S
5600 - H
5600 - W
5600 - B
€ 45.50

**Additional pages:** Pack of 50 € 24.00

☒ **5601** One pocket: DIN A5 / 148 x 210 mm (Format: 168 x 218 mm).

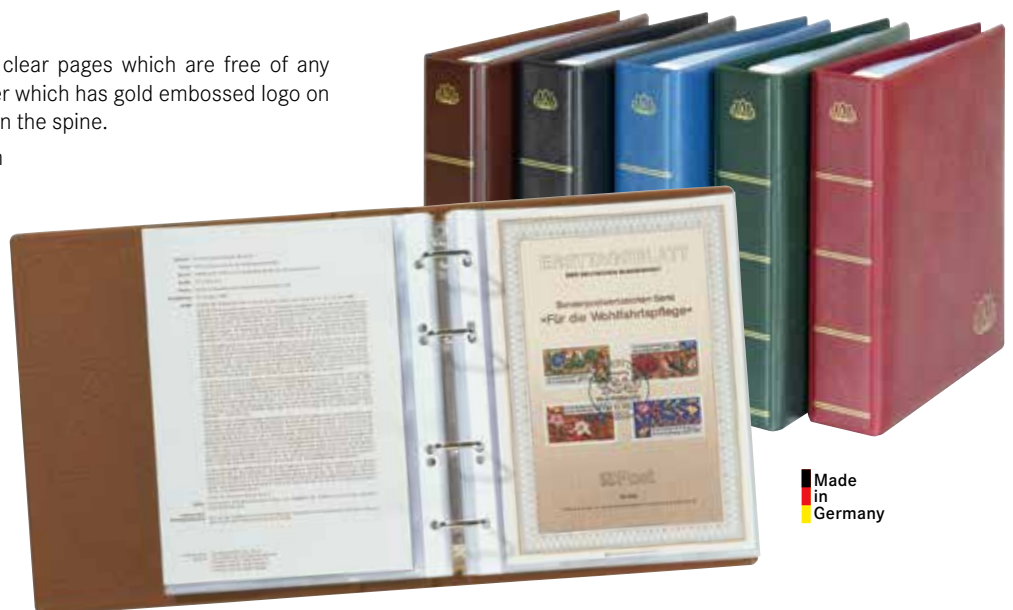

For storing First Day Sheets from Germany and West Berlin in our ring binders Order no. 1104, 1102L, 1102Y, 1104 and SRS we suggest using the LINDNER T-Blank-page Order no. 802104.

# POSTCARD ALBUMS XL



## RING BINDER PUBLICA XL

Ring binder in black, made of padded synthetic-foil for a space-saving, secure and representative storage of collectibles. The generous spine window offers plenty of space for content labelling. Fits our postcard pages XL.

**Format Ring binder:** 390 x 345 x 60 mm  
**Mechanism:** 4-ring, 80/80/80 mm (Standard)

3560  
 € 52.00

## RING BINDER STANDARD XL

The ring binder "Standard" has been a long time staple in our product line! The album is made of a padded, smooth vinyl with an index window on the spine.

**Format Ring binder:** 390 x 345 x 60 mm  
**Format Ring binder incl. Slipcase:** 400 x 360 x 70 mm  
**Mechanism:** 4-ring, 80/80/80 mm (Standard)

### Capacity:

approx. 50 Postcard pages XL – black  
 approx. 50 Postcard pages XL – grey  
 approx. 70 Postcard pages XL – crystal clear

## POSTCARD PAGES XL

The transparent page variations can be filled on one side. This way the content can be viewed from both its back and front side. The black and grey page variations can be filled on both sides and offer a maximum of space.

**Format:** 350 x 335 mm.

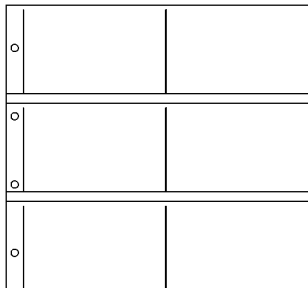

horizontal,  
for 2x 6 postcards  
up to 165 x 105 mm.

Pieces	Pack of 10
● 3050	● 3050P
○ 3060	○ 3060P
€ 7.50	€ 34.50

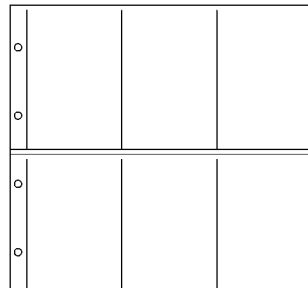

vertical,  
for 2x 6 postcards  
up to 108 x 160 mm.

Pieces	Pack of 10
● 3051	● 3051P
● 3011*	● 3011P*
○ 3061	○ 3061P
€ 7.50	€ 34.50

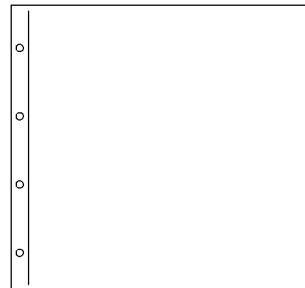

without dividers,  
inside dimension:  
330 x 330 mm.

Pieces	Pack of 10
● 3052	● 3052P
● 3013*	● 3013P*
○ 3062	○ 3062P
€ 7.50	€ 34.50

**Made in Germany**

Black Interleaving for crystal clear pages.

Pack of 10  
 3560Z  
 € 10.00

● black  
 ● grey  
 ○ crystal clear

For storing postcards in 18-ring binders we suggest using the transparent pages Order no. 826 and 829 as well as the Omnia page Order no. 021 (see page 70 and 71). Protective sleeves for postcards (see page 92).

\*Delivery only while stocks last.

Prices do not include contents / display material. All prices and specifications are subject to change without prior notice.

### MULTI COLLECT-POSTCARD ALBUM



Multi collect-ring binder (Order no. 1300) incl. 30 double-sided, black postcard pages (Order no. MU1312).

- Large capacity (up to 60-70 pages for postcards)
- Wide spine with index window
- Multifunctional and versatile – other page options for coins, stamps, banknotes, etc. are available!

**Format Ring binder:** 245 x 270 x 80 mm

**Mechanism:** 4-ring, 40/80/40 mm

**Capacity:** approx. 40 Postcard pages (Order no. MU1312)

	
🛒 1300PK - G	🛒 1301 - G
🛒 1300PK - S	🛒 1301 - S
🛒 1300PK - B	🛒 1301 - B
🛒 1300PK - H	🛒 1301 - H
🛒 1300PK - W	🛒 1301 - W
€ 60.50	€ 26.00

Details as well as other possibilities for using our versatile Multi collect-system are found on page 78-79.



Additional pages: Pack of 10 € 12.50  
 🛒 MU1312 Multi collect Postcard pages



### POSTCARD ALBUM CLASSIC

This high-quality album is made of an elegant padded, leatherette material plus a clear index window on the spine. This album comes with 20 crystal clear, 2-pocket pages, (Order no. 811) to hold items size 155 x 110 mm.

**Format Ring binder:** 200 x 235 x 40 mm

**Mechanism:** 13-ring

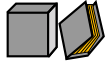
**Capacity:** approx. 35 Postcard pages (Order no. 811)

			
🛒 1103K - G	🛒 1131 - G	🛒 1103Y - G	🛒 810CY - G
🛒 1103K - S	🛒 1131 - S	🛒 1103Y - S	🛒 810CY - S
🛒 1103K - B	🛒 1131 - B	🛒 1103Y - B	🛒 810CY - B
🛒 1103K - W	🛒 1131 - W	🛒 1103Y - W	🛒 810CY - W
€ 47.50	€ 56.00	€ 29.50	€ 22.00



Additional pages: Pack of 10 € 12.50  
 🛒 811 2 pockets: 155 x 110 mm (Format: 174 x 224 mm).

### POSTCARD ALBUM LOTOS

Postcard album incl. 50 transparent pages with 2 pockets (150 x 107 mm) made of softener and acid-free foil. Padded ring binder with embossed gold logo on the cover and spine, as well as gold stripes on the spine.

**Format Ring binder:** 194 x 228 x 50 mm

**Mechanism:** 4-ring, 45/65/45 mm

**Capacity:** approx. 50 Postcard pages (Order no. 5801)

🛒 5800 - G
🛒 5800 - S
🛒 5800 - B
🛒 5800 - H
🛒 5800 - W
€ 45.50



Additional pages:  
 Pack of 50 € 24.00  
 🛒 5801  
 2 pockets: 150 x 107 mm  
 (Format: 170 x 221 mm).

For storing postcards in 18-ring binders we suggest using the transparent pages Order no. 826 and 829 as well as the Omnia page Order no. 021 (see page 70 and 71). Protective sleeves for postcards (see page 92).

# UNIPLATE

Versatility and an attractive price are the key arguments in favour of UNIPLATE. Originally developed for the US market many years ago and successfully launched there, this system now also delights collectors in Europe. Collectors benefit from a wide range of high-quality, well-finished plastic sheets with a variety of pocket and strip formats, offering numerous possible uses. Whether stamps, miniature sheets, FDCs, ETBs, stamp booklets, postcards or banknotes – almost everything finds a safe and secure place in the UNIPLATE system.

## 1 UNIPLATE RING BINDER "STANDARD"



Ring binder, made of a blue vinyl material with a smooth, unpadded surface.

## 2 UNIPLATE RING BINDER "LUXUS"

Luxus Ring binder in winered, made of an attractive, padded leatherette material.

**Format Ring binder:** 270 x 295 x 65 mm

**Mechanism:** 3-ring, 110/110 mm

		
🛒 1712	🛒 1710	🛒 1711
€ 56.50	€ 34.50	€ 26.00
🛒 1700		
€ 29.00		

## UNIPLATE STOCKPAGES

UNIPLATE sheets are made from chemical softener-free and acid-free synthetic-foil with welded insertion strips. The sheets fit the UNIPLATE Standard ring binders (item no. 1700) and Luxury ring binders (item no. 1710).

Overall sheet size: 215 x 280 mm

The black UNIPLATE sheet variants can be loaded on both sides. The crystal-clear UNIPLATE sheet variants are designed for single-sided loading, allowing both the front and reverse of the contents to be viewed clearly.



Made in Germany

**Capacity:**  
 approx. 70 UNIPLATE Pages – black  
 approx. 80 UNIPLATE Pages – crystal clear

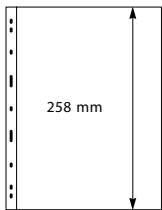

1 strip  
258 x 197 mm  
Pack of 5:  
● 071 € 8.50  
○ 091 € 8.00

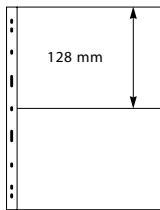

2 strips  
128 x 197 mm  
Pack of 5:  
● 072 € 8.50  
○ 092 € 8.00

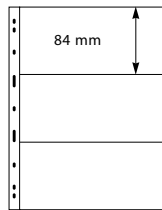

3 strips  
84 mm x 197 mm  
Pack of 5:  
● 073 € 8.50  
○ 093 € 8.00

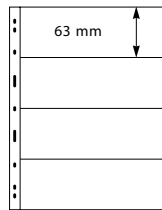

4 strips  
63 x 197 mm  
Pack of 5:  
● 074 € 8.50  
○ 094 € 8.00

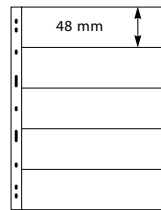

5 strips  
48 x 197 mm  
Pack of 5:  
● 075 € 8.50

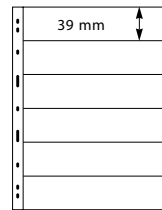

6 strips  
39 x 197 mm  
Pack of 5:  
● 076 € 8.50

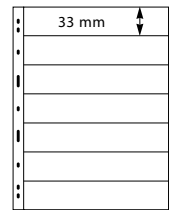

7 strips  
33 x 197 mm  
Pack of 5:  
● 077 € 8.50

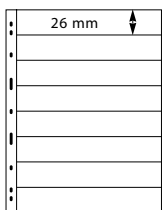

8 strips  
26 x 197 mm  
Pack of 5:  
● 078 € 8.50

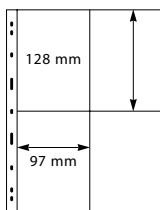

4 pockets  
128 x 97 mm  
Pack of 5:  
● 079 € 8.50  
○ 099 € 8.00

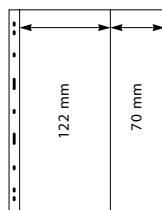

2 strips  
276 x 122 and 70 mm  
Pack of 5:  
● 062 € 8.50  
○ 082 € 8.00

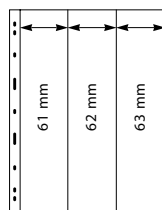

3 strips  
276 x 61, 62 and 63 mm  
Pack of 5:  
● 063 € 8.50  
○ 083 € 8.00

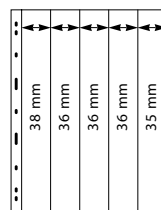

5 strips  
276 x 38, 36 and 35 mm  
Pack of 5:  
● 065 € 8.50  
○ 085 € 8.00

Pages 100% free from chemical softeners

- black (Pages are double-sided.)
- crystal clear

🛒 1786 Black cardboard interleaving pages for crystal clear stockpages, pack of 5. € 5.50

# APPROVAL CARDS

## PLASTIC APPROVAL CARDS MADE OF CARDBOARD WITH TRANSPARENT PROTECTIVE FLAP

Format: 158 x 113 mm, made of one-sided black cardboard (300 g/m<sup>2</sup>) with softener-free crystal clear foil strips and cover sheet. Strips open on the side.



With 3 strips, height: 18 mm  
Pack of 100.

☛ S869-3-P100 € 17.90



With 4 strips, height: 15 mm  
Pack of 100.

☛ S869-4-P100 € 17.90



Format: 210 x 148 mm, made of one-sided black cardboard (300 g/m<sup>2</sup>) with softener-free crystal clear foil strips and cover sheet. Strips open on the side.



With 5 strips, height: 14 mm  
Pack of 100.

☛ S871-5-P100 € 27.90



Fitting cases  
on page 19.

## PLASTIC APPROVAL CARDS »EXTRA« MADE OF HARD-PVC

Format: 145 x 83 mm, made of hard-PVC which is 100 % free of any chemical softeners. Strips open on the side.



With one strip, height: 80 mm  
Pack of 100.

☛ 751 € 25.00

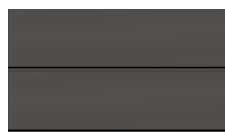

With two strips, height: 38 mm  
Pack of 100.

☛ 752 € 25.00



### Matching protective sleeves Pack of 100

Protective sleeves, free of chemical softeners

149 x 86 mm (Inner measurements) ☛ 758 € 22.50

## APPROVAL CARDS MADE OF HARD-PVC

Format: 210 x 143 mm, made of black hard-PVC-material (400 my) with welded, crystal clear strips (100 my), free of chemical softeners. Strips closed on the side.



1 strip, height: 137 mm  
Pack of 10.

☛ 771 € 15.50

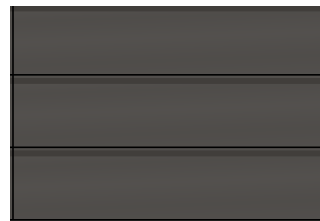

3 strips, height: 43 mm  
Pack of 10.

☛ 773 € 15.50

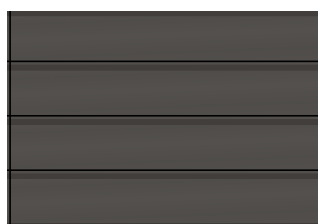

4 strips, height: 30 mm  
Pack of 10.

☛ 774 € 15.50



5 strips, height: 24 mm  
Pack of 10.

☛ 775 € 15.50



6 strips, height: 19 mm  
Pack of 10.

☛ 776 € 15.50



Set of 6 index cards,  
white  
☛ K-KR € 2.90



## APPROVAL CARD BOX

### EMPTY

The practical approval card Box from LINDNER is made from a sturdy, black plastic and offers space for approximately 60 cards (Order no. 771-776). Appropriate for single stamps, sets, small blocks, postal cards, etc. Index cards help to keep everything organised.

Format: 220 x 165 x 65 mm

Suited for: Approval Cards A5

☛ 870 Stamp Box File, empty € 39.50

# ERNI – STAMP CARE PRODUCTS

FOR PROFESSIONAL TREATMENTS OF STAMPS



It's all about retaining the value and perfection! ERNI products help the collector improve the value and condition of used stamps! The complete set provides all-round care for all kinds of different "problems".

**Mildew Stain Remover ERNI A**  
Content: 200 ml  
€ 8070  
€ 21.00

**Mildew Stain Remover ERNI B**  
Content: 200 ml  
€ 8071  
€ 21.00

**ERNI Stamp Remover for self-adhesive Stamps**  
Removes self-adhesive stamps from covers, postcards etc.  
Content: 200 ml  
€ 8080  
€ 24.00

**ERNI Stamp Gum Remover**  
Content: 200 ml  
€ 8072  
€ 24.00

**ERNI "Schon" Hinge Mark Remover**  
Content: 200 ml  
€ 8073  
€ 24.00

**LINDNER Stamp Remover**  
...removes stamps without water! Gum and existing numbers on the back of coil stamps will be retained if the product is applied from the back of the paper. Used properly, the stamp remover is absolutely safe.  
Content: 100 ml  
€ 8060  
€ 16.50

ERNI A and ERNI B must be used together.



Trays, Pack of 2.  
Format: 94 x 68 x 29 mm  
€ 8076 € 5.00

Identification according to Regulation (EC) No. 1272/2008 Statements:

**ERNI A (€ 8070)**  
**Caution**

H315 Causes skin irritation.  
H319 Causes serious eye irritation.  
H411 Toxic to aquatic life with long lasting effects.



**ERNI B (€ 8071)**  
**Caution**

H290 Can be corrosive to metals.  
H315 Causes skin irritation.  
H319 Causes serious eye irritation.  
H317 Can cause allergic reactions to your skin.  
H351 Suspected of causing cancer.  
H373 May cause damage to organs through prolonged or repeated exposure.



**LINDNER Stamp Remover (€ 8060)**  
**Danger**

H318 Causes serious eye damage.



## FLAG-STICKERS

These flag-stickers can be used for proper identification of a collection. They are self-adhesive and can be attached to the binder, or placed inside the plastic window on the spine of the LINDNER ring binders.

Pack of 6 € 6.50



Made in Germany

Deutsches Reich	€ 628
Germany	€ 630
West Berlin	€ 632
East Germany GDR	€ 634
Aland	€ 666
Andorra	€ 665
Bulgaria	€ 639
Belgium	€ 635
Denmark	€ 641
Estonia	€ 645
Europe	€ 655
Faroe Islands	€ 642
Finland	€ 667
France	€ 636
Gibraltar	€ 651
Greece	€ 652
Greenland	€ 643
Great Britain	€ 660

Guernsey	€ 661
Ireland	€ 664
Iceland	€ 668
Italy	€ 647
Jersey	€ 662
Latvia	€ 653
Lithuania	€ 659
Liechtenstein	€ 640
Luxembourg	€ 654
Malta	€ 672
Isle of Man	€ 663
Monaco	€ 650
Netherlands	€ 637
Norway	€ 669
Austria	€ 644
Poland	€ 673
Portugal	€ 671
Romania	€ 674

Russia	€ 682
San Marino	€ 649
Sweden	€ 670
Switzerland	€ 646
Slovakia	€ 676
Slovenia	€ 677
Soviet Union	€ 681
Spain	€ 638
Czech Republic	€ 678
Ukraine	€ 683
Hungary	€ 679
Vatican	€ 648
United Nations	€ 656
Belarus	€ 684
Canada	€ 658
Israel	€ 675
USA	€ 657
Cyprus	€ 680

## PRICE LABELS

(Pack of 1000)



Format: 23 x 27 mm  
 € 802024  
 € 14.00



Format: 25 x 30 mm  
 € 802022  
 € 14.00



Format: 31 x 36 mm  
 € 802023  
 € 16.00

Made in Germany

## DRYING BOOKS

LINDNER drying books are the ideal tool for drying stamps that were removed from paper.

1 Drying Book, heavy laminated cover, spiral binding and 10 blotting sheets with safety interleaving for all gum types. Size: DIN A4  
 € 845 € 23.50

2 Drying Book, plain, 10 pages. Size: DIN A4  
 € 846 € 14.50

3 Drying Book, plain, 10 pages. Size: DIN A5  
 € 847 € 13.00



Made in Germany

## MINT SHEET ALBUMS

The albums are equipped with softener-free foil pockets and glassine interleaves. 100 sheets find place in each of the three albums. The albums are designed for different sheet sizes.

Format: 280 x 325 mm (Holds mint sheets up to size 245 x 315 mm)  
 € 860 € 62.50  
 Slipcase  
 € 860K € 33.50

Format: 280 x 385 mm (Holds mint sheets up to size 240 x 360 mm)  
 € 861 € 68.00  
 Slipcase  
 € 861K € 33.50

Format: 325 x 325 mm (Holds mint sheets up to size 290 x 315 mm)  
 € 862 € 68.00  
 Slipcase  
 € 862K € 33.50

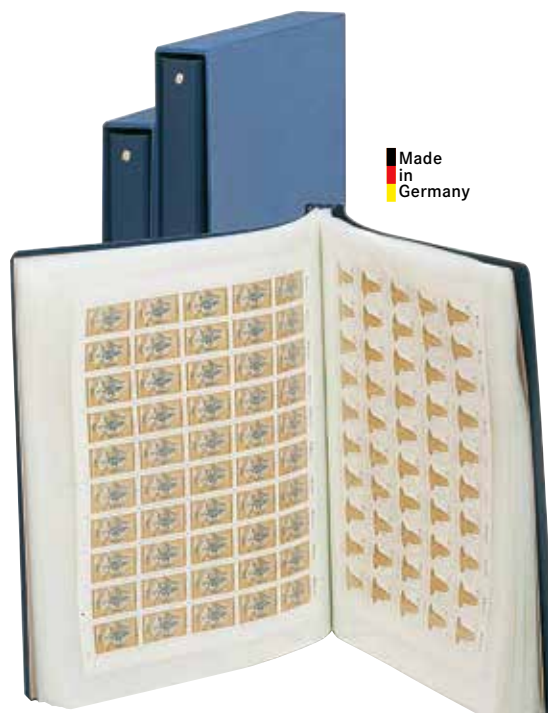

Made in Germany

# STAMP TONGS

## "AN INDISPENSABLE TOOL"

Stamps are very delicate. Never touch stamps with your fingers! To avoid damage of any kind, it is of utmost importance to handle stamps only with good quality stamp tongs. They are an essential tool for every collector.

### STAMP TONGS NICKEL-PLATED

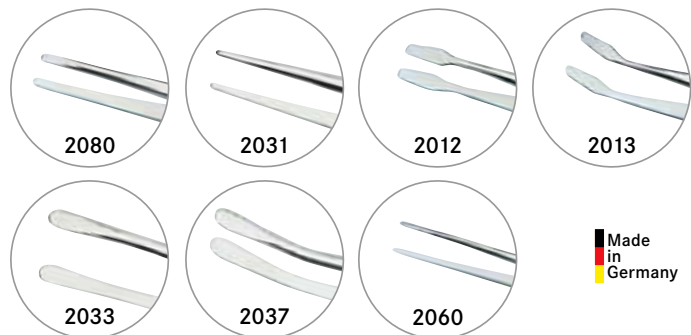

Stamp Tongs 120 mm, Nickel-plated

🛒 2080	long round tip, in a plastic sleeve	€ 9.50
🛒 2031	straight, with pointed tip	€ 9.50
🛒 2012	spade ends - straight, in a plastic sleeve	€ 9.50
🛒 2013	spade ends - bent, in a plastic sleeve	€ 9.50
🛒 2033	straight, with wide, round tip	€ 9.50
🛒 2037	bent, with wide, round tip	€ 9.50



Stamp Tongs 150 mm, Nickel-plated

🛒 2060	with pointed tip, in a plastic sleeve	€ 14.90
--------	---------------------------------------	---------

### STAMP TONGS STAINLESS STEEL

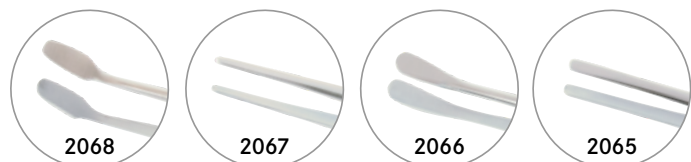

Stamp Tongs, stainless steel (in a plastic sleeve)

🛒 2068	150 mm, bent, with spade ends	€ 21.00
🛒 2067	150 mm, straight, with pointed tip	€ 21.00
🛒 2066	115 mm, bent, with spade ends	€ 21.00
🛒 2065	115 mm, straight, with pointed tip	€ 21.00

# PHILA-COMBI-BOX, PERFORATION GAUGE

Precision perforation gauge from LINDNER for accurate readings! The perforation of the stamp is placed against the raised teeth of the gauge - it's fast, easy and precise! Especially practical: The lid of the box can be used as a tray to detect watermarks by using chemically safe watermark fluid.

Format: 115 x 55 mm

🛒 2099 € 23.50



# LINDNER STAMPSCOP

The LINDNER Stampscop reveals watermarks, damage, repair and thin spots on stamps. The device works with the same principles as the Letter-scope, depending upon how the Stampscope is held up against the light. Instructions are enclosed!

🛒 9111 € 99.50



# ENVELOPES AND SLEEVES MADE OF GLASSINE

For ideal and safe protection of stamps, blocks, sheetlets, envelopes, FDC's, postcards, telephone cards, banknotes, photos and negatives. Glassine envelopes are made out of pure pine wood cellulose which is 100% recyclable. The glassine is transparent, anti-static, chlorine and acid free and does not contain chemical softeners.

Made in Germany



All measurements are internal measurements in mm.  
Pack of 500

Special production on request.

- food safe
- tasteless and odorless
- breathable
- recyclable and compostable
- suitable for archives, because it is ph-neutral
- Paper thickness: 40g/m<sup>2</sup>

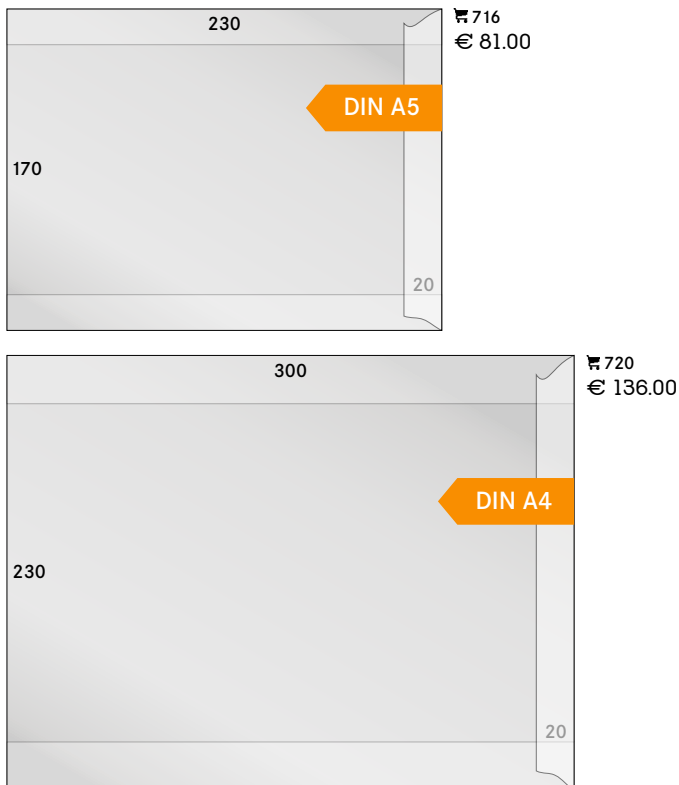
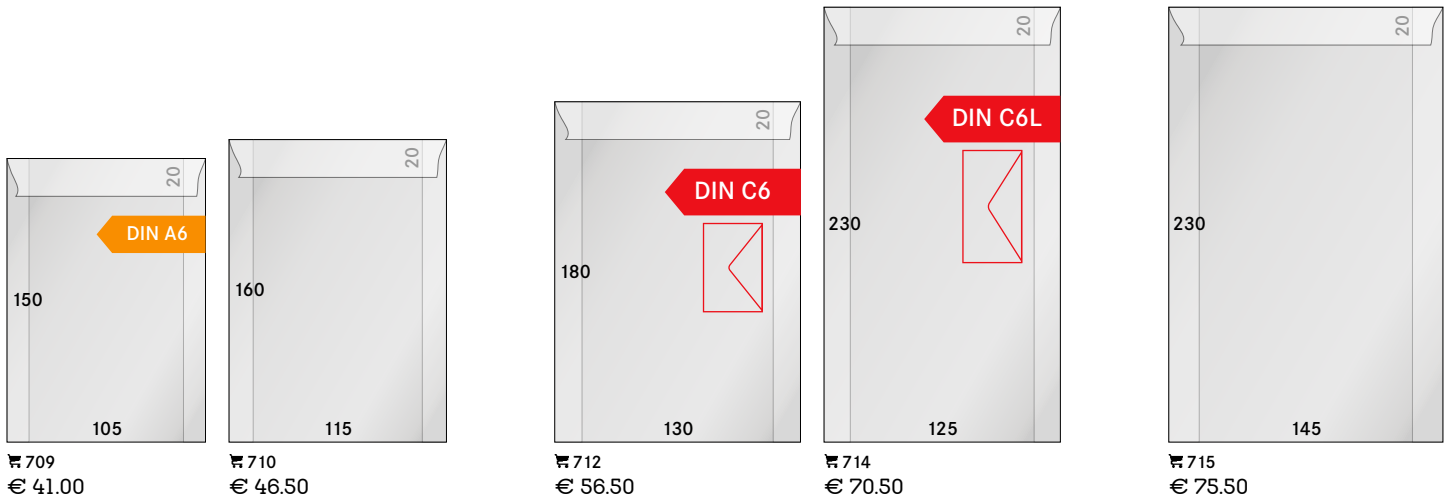

## PERGAMIN SLEEVES

Pack of 100

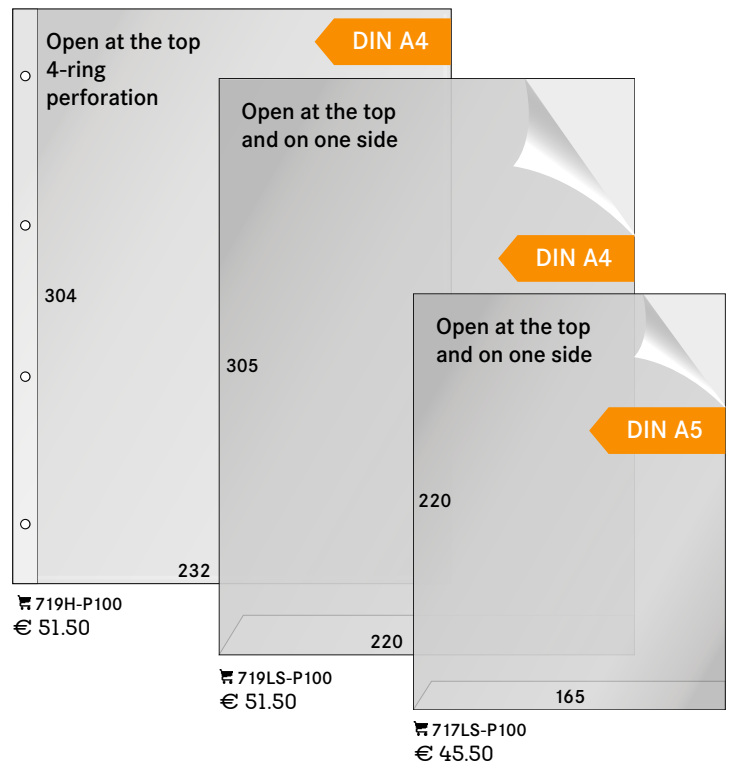

# PROTECTIVE SLEEVES

## FOR POSTCARDS, POSTAL HISTORY, BANKNOTES, PHOTOS, TELEPHONE AND BASEBALL CARDS ETC.

All protective sleeves are made from a crystal clear, acid and chemical softener-free synthetic-foil. Film thickness: 0.1 mm. All measurements are internal measurements in mm. The red line identifies the open side.

Special production on request.

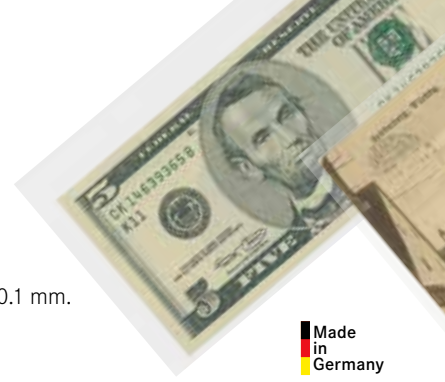

Made in Germany



e.g. for Telephone cards  
Pack of 50 € 13.00

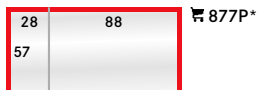

e.g. for Telephone cards with price labels  
Pack of 50 € 13.00



e.g. for Telephone cards  
Pack of 50 € 13.00



e.g. for Protective sleeve for K7E  
Pack of 50 € 13.00

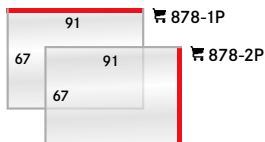

e.g. for Trading cards/  
Baseball cards  
Pack of 50 € 13.00

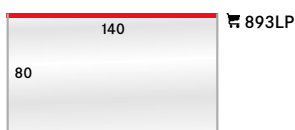

e.g. for Banknotes  
Pack of 50 € 13.00

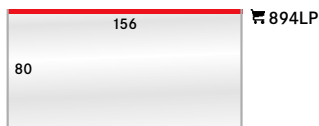

e.g. for Banknotes  
Pack of 50 € 13.00

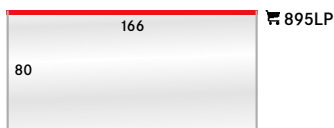

e.g. for Banknotes US-Dollar  
Pack of 50 € 13.00

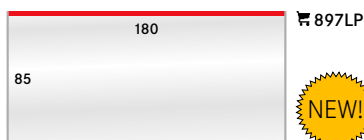

e.g. for banknotes, suitable for banknote sheet 831/851 (p.71) Pack of 50 € 15.50

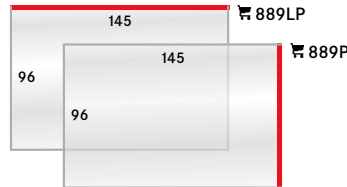

e.g. for old Postcards  
Pack of 50 € 13.00

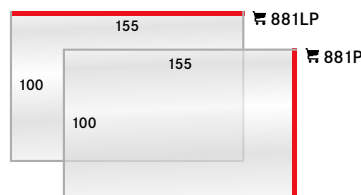

e.g. for modern Postcards  
Pack of 50 € 13.00

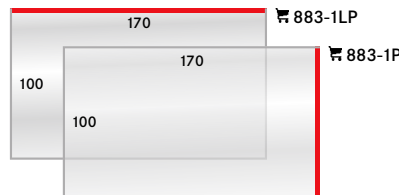

e.g. for FDC, Envelopes US size 6  
Pack of 50 € 14.50

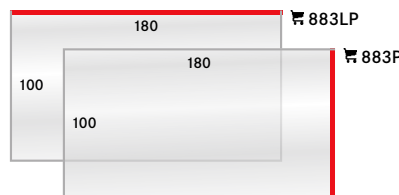

e.g. for FDC  
Pack of 50 € 15.50

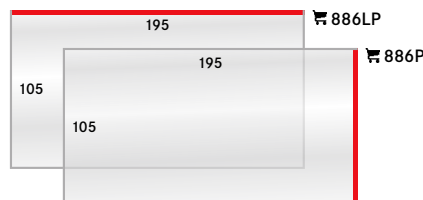

e.g. for European Envelopes long  
Pack of 50 € 15.50

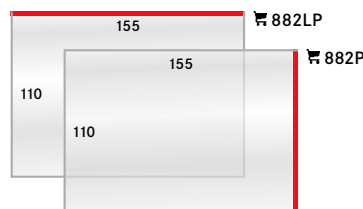

e.g. for modern Postcards,  
small approval cards  
Pack of 50 € 14.50

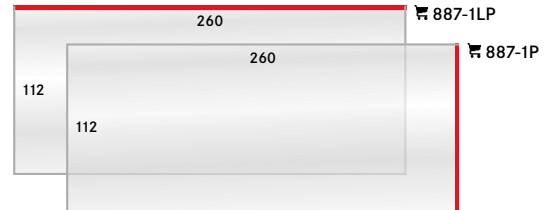

e.g. for Letters in long format, US-Letters no. 10  
Pack of 50 € 20.50

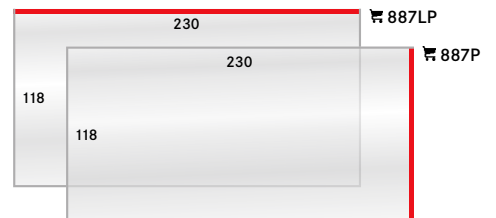

e.g. for Letters DIN C6 long  
Pack of 50 € 20.50

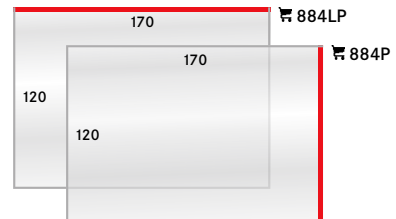

e.g. for European envelopes, DIN C6  
Pack of 50 € 15.50

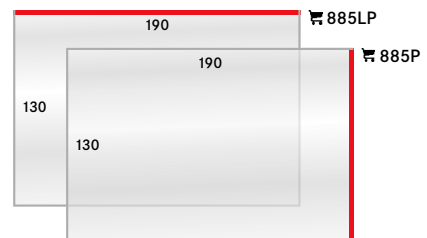

e.g. for larger envelopes  
Pack of 50 € 15.50

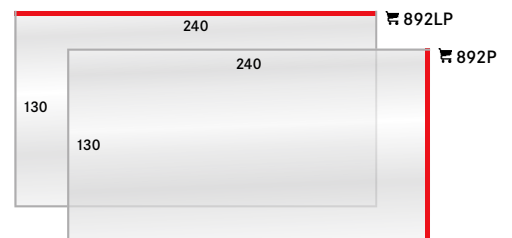

e.g. for Envelopes DIN C4, miniature sheets  
Pack of 50 € 20.50

\*Delivery only while stocks last.

Prices do not include contents / display material. All prices and specifications are subject to change without prior notice.



# FREESTYLE PROTECTIVE SLEEVES

**FOIL SHEETS OF OUR RENOWNED PROTECTIVE COVERS WITH SELF-ADHESIVE STRIP ON THE LEFT SIDE. FOR BANKNOTES, POSTCARDS, LETTERS ETC...**

Using the self-adhesive strip, the covers can be mounted individually on each album page. In this way, the protective covers can be integrated into any conventional collection system.

All protective sleeves are made from a crystal clear, acid and chemical softener-free synthetic-foil. Film thickness: 0.1 mm. **All measurements are internal measurements in mm. The red line identifies the open side.**

Special production on request.

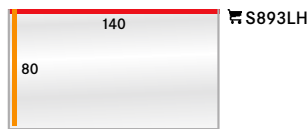

e.g. for Banknotes  
Pack of 25 € 13.00

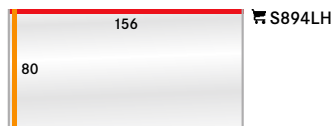

e.g. for Banknotes  
Pack of 25 € 13.00

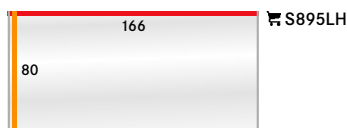

e.g. for Banknotes US-Dollar  
Pack of 25 € 13.00

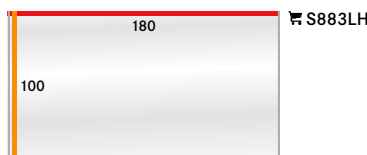

e.g. for FDC  
Pack of 25 € 15.50

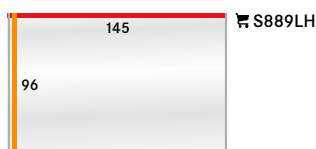

e.g. for old Postcards  
Pack of 25 € 13.00

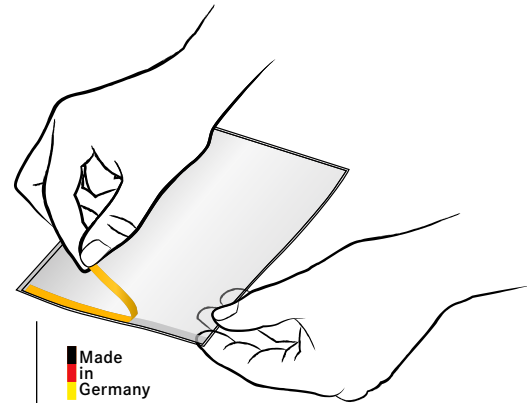

Made in Germany

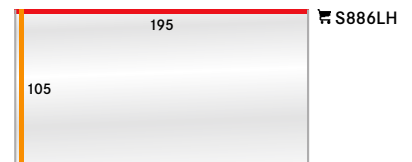

e.g. for European Envelopes long  
Pack of 25 € 15.50



e.g. for modern Postcards, small approval cards  
Pack of 25 € 14.50

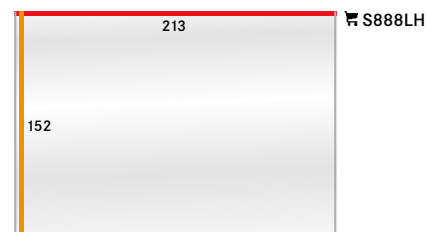

e.g. for DIN A5, ETB's  
Pack of 25 € 20.50

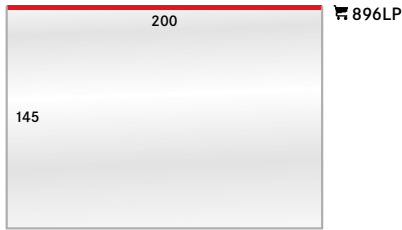

e.g. for DIN A5, ETB's  
Pack of 50 € 20.50

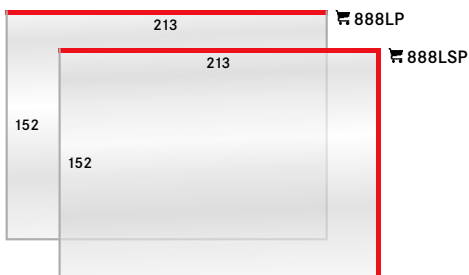

e.g. for DIN A5, ETB's  
Pack of 50 € 20.50

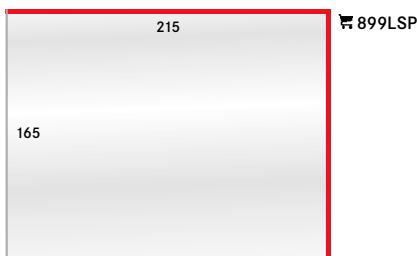

e.g. for DIN A5, ETB's  
Pack of 50 € 20.50

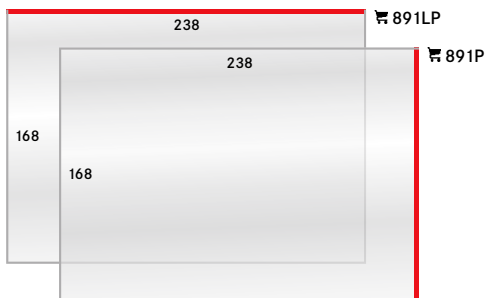

e.g. for DIN A5, ETB's  
Pack of 50 € 20.50

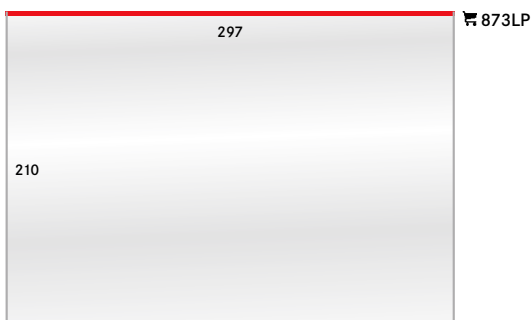

e.g. for DIN A4  
Pack of 50 € 44.50

# POLY BAGS WITH PRESS-LOCK

with approx. 20 mm flap. Material: LPDE film. Packaging unit: Pack of 100.

All measurements are internal measurements in mm.

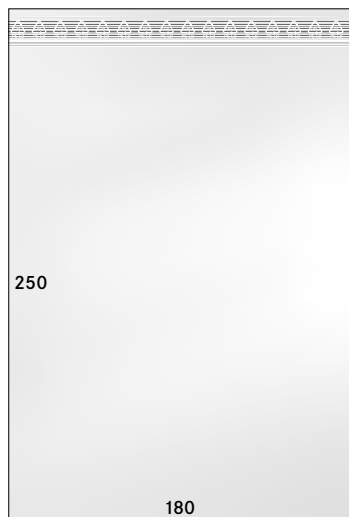

787  
€ 25.00

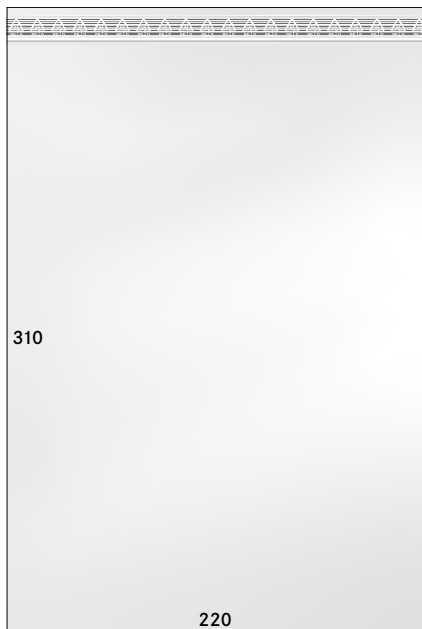

788  
€ 32.00

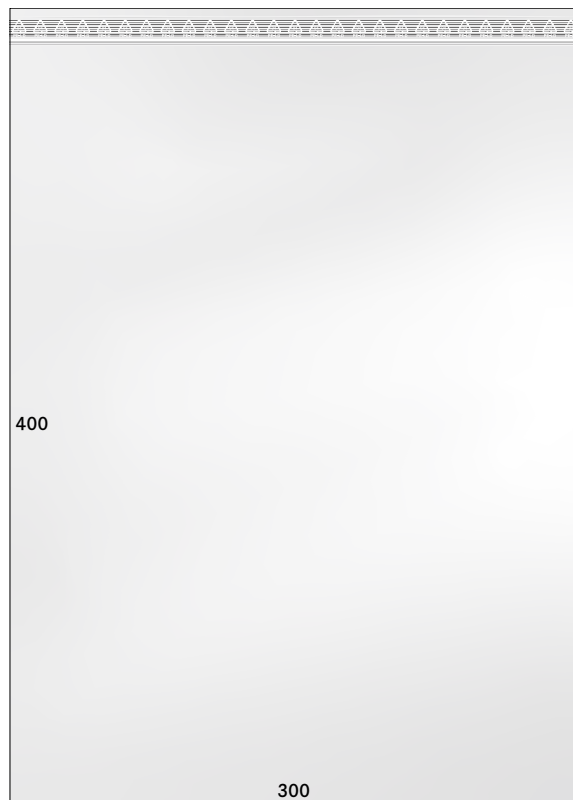

789  
€ 42.50

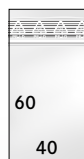

780  
€ 3.50

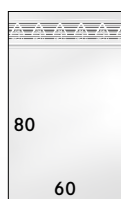

781  
€ 4.00

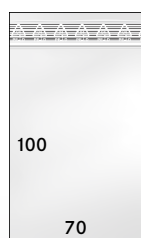

782  
€ 4.50

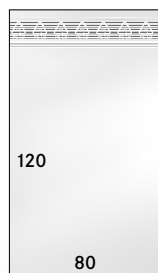

783  
€ 6.00

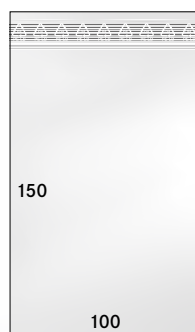

784  
€ 7.50

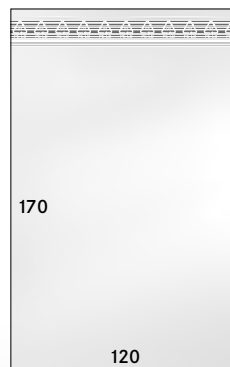

785  
€ 9.00

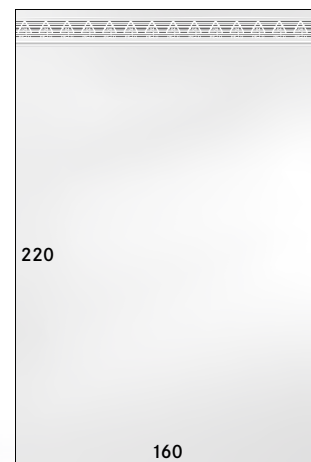

786  
€ 20.50

780	40 x 60 mm	€ 3.50
781	60 x 80 mm	€ 4.00
782	70 x 100 mm	€ 4.50
783	80 x 120 mm	€ 6.00
784	100 x 150 mm	€ 7.50
785	120 x 170 mm	€ 9.00
786	160 x 220 mm	€ 20.50
787	180 x 250 mm	€ 25.00
788	220 x 310 mm	€ 32.00
789	300 x 400 mm	€ 42.50



# RING BINDER SERIES PUBLICA

## THE RIGHT FORMAT FOR EVERY COLLECTION

The high-quality ring binders from our PUBLICA series have a uniform, classical and timeless look. Time tested, durable materials guarantee many years of use. The padded, grained leatherette gives the ring binder its unique character. Each size – PUBLICA is designed for a different style and size of page to fit a variety of collections. Whether you collect coins, stamps, banknotes, FDC's or postcards – the PUBLICA series offers a storage solution for you. All binders come in black, with the LS & M series also available in other colours. The wide spine offers lots of room and a synthetic window provides space for identification labels/description of the contents.



**XL**

**LS**

**M**

**S**



**karat**

Made in Germany

## RING BINDER PUBLICA S

Black, ring binder made of padded synthetic foil for space-saving, secure and attractive storing. A synthetic window on the spine provides space for labels. This binder is suitable for our karat-coin pages.

**Format:** 225 x 240 x 60 mm

**Mechanism:** 4-ring, 45/65/45 mm

**Capacity:** about 25 karat-coin pages depending on the size of the coins



₹ 3520  
€ 26.50

Suitable for our karat-coin pages see page 32.

## RING BINDER PUBLICA M

### A SPACE-SAVING, SAFE AND ATTRACTIVE RING BINDER FOR COINS AND BANKNOTES

The high-quality ring binder from the PUBLICA series offers a uniform, classical and timeless design. The sturdy construction and the quality materials selected for this ring binder guarantee many years of use. The padded leatherette cover has a 4-ring mechanism and is also available with a matching slipcase. A large, clear index window on the spine allows you to insert a description for easy identification of the contents. Matching pages see page 78-79.

**Format Ring binder:** 245 x 270 x 60 mm

**Format Ring binder incl. Slipcase:** 250 x 280 x 75 mm

**Mechanism:** 4-ring, 45/65/45 mm

**Capacity:**

approx. 15 Multi collect-coin pages

approx. 50 Multi collect-stockpages – black

approx. 70 Multi collect-stockpages – crystal clear

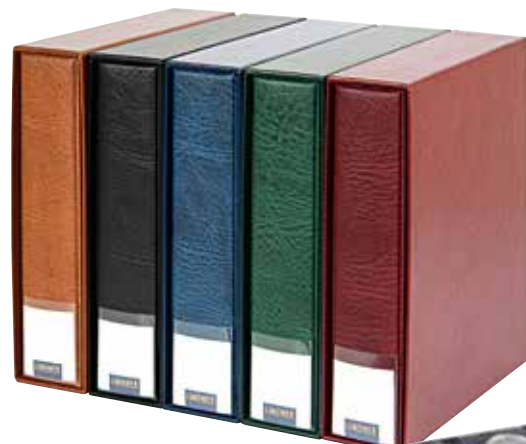

Made in Germany



₹ 3532 - G	₹ 3530 - G	₹ 3531 - G
₹ 3532 - S	₹ 3530 - S	₹ 3531 - S
₹ 3532 - B	₹ 3530 - B	₹ 3531 - B
₹ 3532 - H	₹ 3530 - H	₹ 3531 - H
₹ 3532 - W	₹ 3530 - W	₹ 3531 - W
€ 46.00	€ 33.00	€ 21.00

## PUBLICA M

# COLOR



The large capacity enhances the modern and fresh appearance of these high-quality, padded ring binders. The robust and sturdy material guarantee an extensive durability of this ring binder. The standard mechanism allows it to be used universally. A pocket on the inside of the binder offers room for content labeling. Matching pages see page 78-79.

**Format Ring binder:** 245 x 270 x 60 mm

**Format Ring binder incl. Slipcase:**  
250 x 280 x 75 mm

**Mechanism:** 4-ring, 45/65/45 mm



☒ S3542 - 1

☒ S3542 - 9

☒ S3542 - 5

☒ S3542 - 4

☒ S3542 - 13

€ 41.50



Made  
in  
Germany

## "READY-TO-USE" ALBUMS

### BANKNOTE ALBUM



☒ S3542BN - 1

☒ S3542BN - 9

☒ S3542BN - 5

☒ S3542BN - 4

☒ S3542BN - 13

€ 49.50

The album comes with 10 double-sided Multi collect-stock pages in 2 sizes (Order no. MU1404 and MU3103).

### STOCKPAGE ALBUM

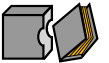

☒ S3542B - 1

☒ S3542B - 9

☒ S3542B - 5

☒ S3542B - 4

☒ S3542B - 13

€ 49.50

The album comes with 10 double-sided Multi collect-stock pages for stamps in 2 sizes (Order no. MU1315 and MU1316).

### PHOTO ALBUM / POSTCARD ALBUM



☒ S3542PK - 1

☒ S3542PK - 9

☒ S3542PK - 5

☒ S3542PK - 4

☒ S3542PK - 13

€ 49.50

The album comes with 10 double-sided Multi collect-stock pages (Order no. MU1404).

### COIN ALBUM



☒ S3542M - 1

☒ S3542M - 9

☒ S3542M - 5

☒ S3542M - 4

☒ S3542M - 13

€ 49.50

The album comes with 10 Multi collect-coin pages in 5 sizes (Order no. MU15, MU24, MU35, MU54 and MU40).

#### EVERY ALBUM CAN BE FILLED UP WITH FURTHER PAGES!

The LINDNER Multi collect-system offers a wide selection of high-quality stockpages with many different variations of pockets and almost endless possibilities. See on page 78-79.

# PUBLICA LS

**Format:** 290 x 315 x 60 mm

**Format Ring binder incl. Slipcase:**  
295 x 325 x 70 mm

Ring binder made of padded synthetic-foil with standard mechanism.

For space-saving, safety and representative storing. The large index-window on the spine offers space for content labeling.

Suitable for our stockpages and other pages in DIN A4 format with standard hole punch.

**Mechanism:** 4-ring, 80/80/80 mm (Standard)

Made in Germany

**Capacity:**  
approx. 50 stockpages – black  
approx. 70 stockpages – crystal clear  
approx. 5 Champagne lid pages

3533 - G	3503 - G	3504 - G
3533 - S	3503 - S	3504 - S
3533 - B	3503 - B	3504 - B
3533 - H	3503 - H	3504 - H
3533 - W	3503 - W	3504 - W
€ 57.00	€ 41.00	€ 26.50

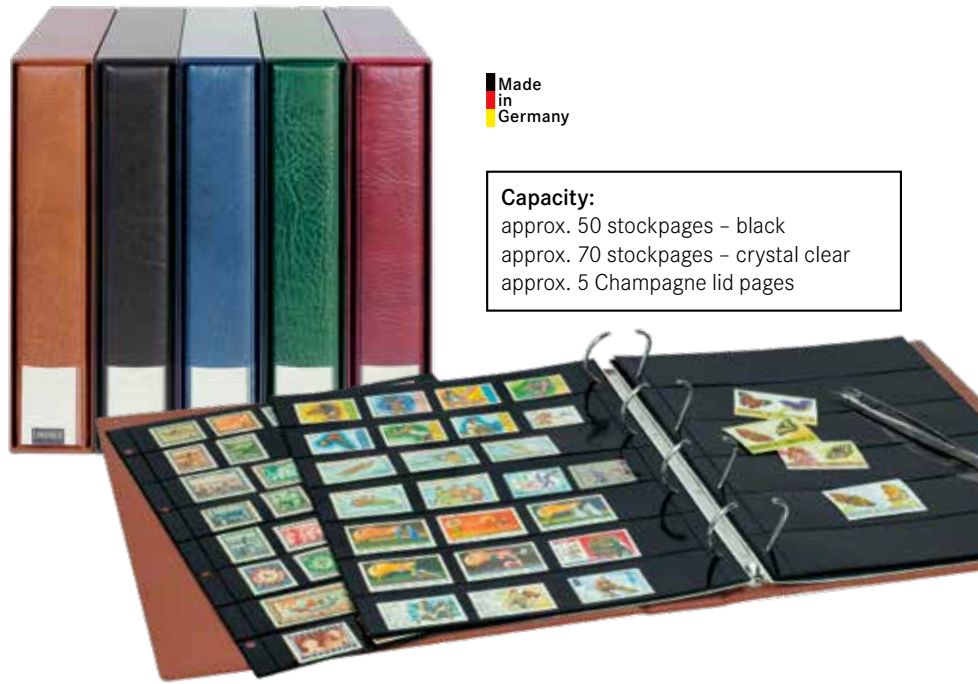

## STOCKPAGES FOR PUBLICA LS

Made in Germany

 Pack of 10 ● 4101 € 21.00 ○ 8811 € 20.00	 Pack of 10 ● 4102 € 21.00 ○ 8812 € 20.00	 Pack of 10 ● 4103 € 21.00 ○ 8813 € 20.00	 Pack of 10 ● 4146 € 21.00 ○ 8844 € 20.00	 Pack of 10 ● 4106 € 21.00
 Pack of 10 ● 4107 € 21.00	 Pack of 10 ● 4108 € 21.00	 Pack of 10 ○ 4066 € 20.00	 Pack of 10 ○ 8849 € 20.00	 Pack of 10 ○ 8846 € 20.00



**Champagne lid pages**  
The lids are inserted from the back into the page. The front of the capsule is always protected.  
Material: crystal-clear plastic  
Format: 240 x 305 mm

● **Black stockpages**  
Black stockpages with crystal clear strips or pockets on both sides.  
Material: Acid and softener-free hard-PVC-foil.  
Format: 240 x 305 mm

○ **Crystal clear stockpages**  
Interleaving black. One-sided crystal clear stockpages. Items can be viewed from front and back.  
Material: Acid and softener-free hard-PVC-foil.  
Format: 240 x 305 mm

○ **Crystal clear stockpages**  
Material: softener-free PP-foil.  
Format: 240 x 305 mm

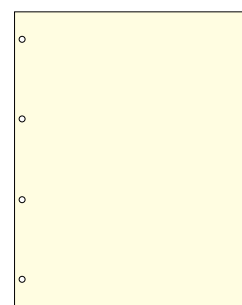

**Blank pages**  
With 4-ring perforation, Size PUBLICA L: 235 x 298 mm.  
Material: 200 g/qm

Made in Germany

Pack of 5  
○ 3502 € 29.00

Pack of 10  
● 8060 € 12.50

# STORAGE AND DISPLAY OF TRADING CARDS AND COLLECTIBLE CARDS

## ALBUM FOR UP TO 450 TRADING CARDS AND COLLECTIBLE CARDS

**Padded PUBLICA LS ring binder in trading card design.**

With 25 crystal-clear plastic insert sheets for 9 trading cards each in 2.5 x 3.5 inch format (max. 65 x 90 mm). When double-loaded, each insert sheet can hold 18 trading cards. This means that up to 450 trading cards can be stored. Thanks to its large capacity, at least 25 additional insert sheets can be added to the album. The additional sheets are available separately. The high-quality insert sheets offer perfect protection and a crystal-clear view of the contents at all times.

**Format:** 290 x 315 x 60 mm

**Mechanism:** 4-ring , 80/80/80 mm (Standard)

**Capacity:** approx. 70 stockpages

🏷️ 3602 € 44.50

**Motif ring binder, empty**

🏷️ 3602R € 34.00

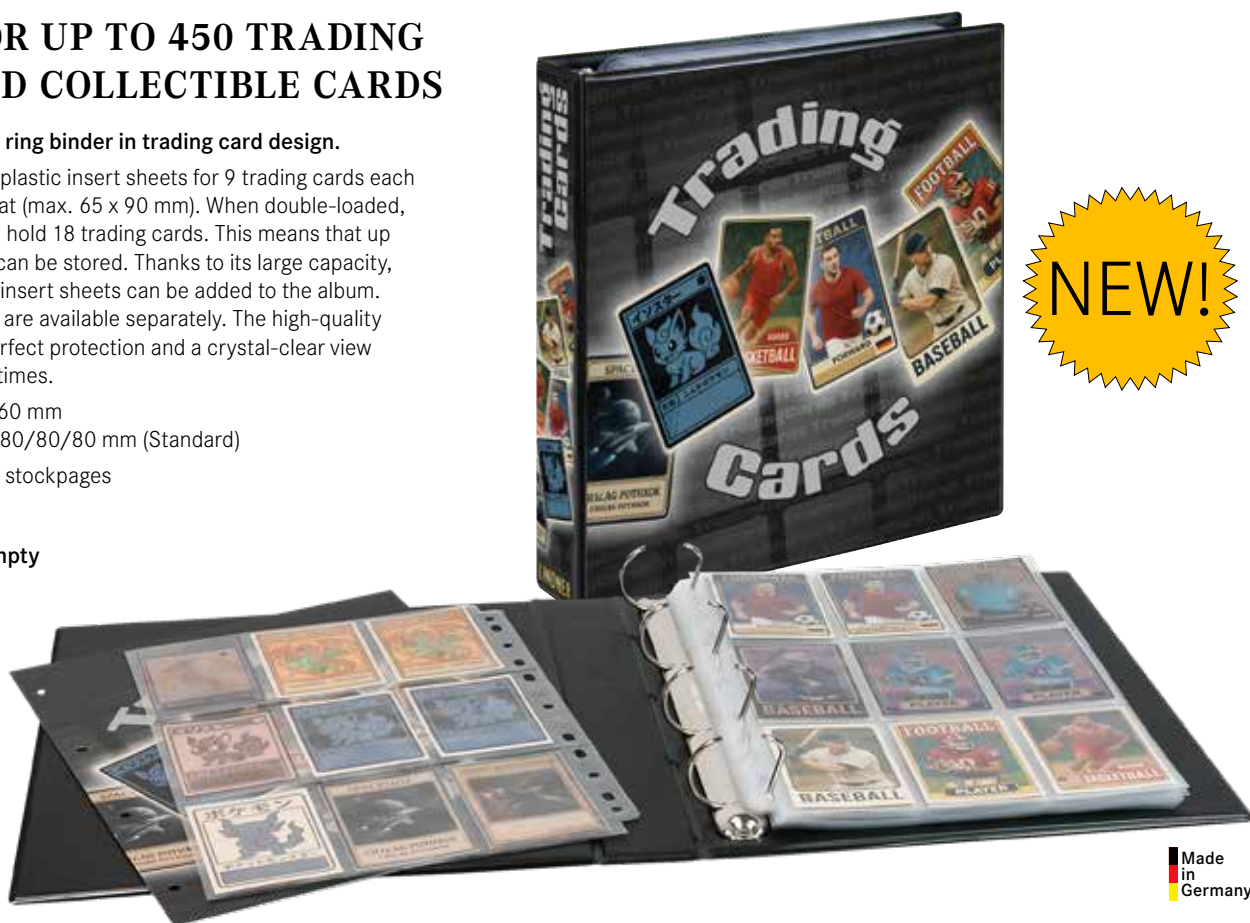

Made in Germany

## STOCKPAGES

Crystal-clear plastic stockpages for 9 trading cards each, or 18 trading cards each when double-loaded. The cards are inserted into the pockets from above. The high-quality stockpages offer perfect protection and a clear view of the contents at all times.

**For trading cards in 2.5 x 3.5 inch format (max. 65 x 90 mm)**

Thanks to the universal 11-hole perforation, the insert sheets fit into almost all standard collector's binders. These stockpages are also included in the trading card album 3602.

**Format:** 227 x 290 mm

Pack of 25

🏷️ 854 € 12.50

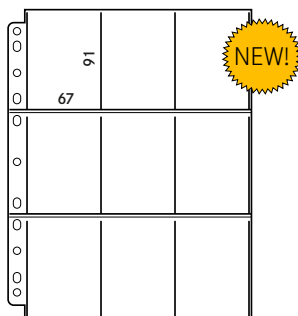

**Insert sheets with larger pockets for trading cards in protective sleeves**

Thanks to their larger pocket size (approx. 72 x 100 mm), these sheets offer space for trading cards in protective sleeves, providing all-round protection for the trading cards.

Standard perforation 80/80/80.

**Format:** 240 x 310 mm

Pack of 10

🏷️ 8849 € 20.00

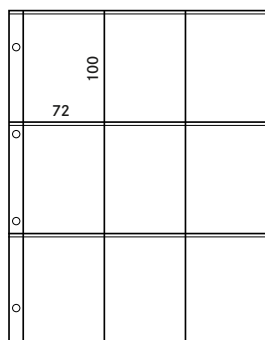

Made in Germany

## PREMIUM DECK BOX

**with magnetic closure for trading cards with or without protective sleeves**

The sturdy box provides space and protection for up to 200 trading cards without protective sleeves and 100 trading cards in protective sleeves. The strong magnetic closure keeps the box securely closed at all times.

**Format:** 80 x 105 x 80 mm

🏷️ 8850 € 16.90



Our NIMBUS object frames (see page 107) are also ideal for displaying very special items.

**Crystal-clear plastic protective covers made of rigid PVC film**

For individual trading cards measuring up to 65 x 90 mm. Insert on the narrow side. The protective sleeves offer perfect protection and a crystal-clear view of the contents at all times.

External dimensions: 71 x 94 mm

Pack of 50

🏷️ 878-2P € 13.00



Made in Germany

This page contains AI-generated content.

# COLLECTION/PRESENTATION BOXES FOR SWISS POCKET KNIVES

Pocket knives are not only practical and helpful equipments for hobby, leisure and work. They are also popular and desired collectibles. We at LINDNER have also developed options to store and present these “treasures” in a representative and protected manner.

- Drawer in smoked glass finish
- Crystal clear frame made of scratch-resistant and robust synthetic material
- Perfectly fitting inserts made of high quality “BLACK SAMT”-foam
- Stackable



Made in Germany

## AVAILABLE IN FOUR VARIANTS:



LINDNER Collection-/Presentation box for 12 Swiss pocket knives VICTORINOX\* model “Cadet”, Length 84 mm (folded up) as well as for other models in same size and type.  
Max. thickness of knife: approx. 27 mm  
**Format:** 236 x 303 x 40 mm

€ 2476  
**€ 52.00**



LINDNER Collection-/Presentation box for 21 Swiss pocket knives VICTORINOX\* model “Classic”, Length 58 mm (folded up) as well as for other models in same size and type  
**Format:** 236 x 303 x 30 mm

€ 2874  
**€ 52.00**



LINDNER Collection-/Presentation box for 12 Swiss pocket knives VICTORINOX\* models “Pioneer” and “Farmer”, Length 93 mm (folded up) as well as for other models in same size and type.  
Max. thickness of knife: approx. 27 mm  
**Format:** 236 x 303 x 40 mm

€ 2475  
**€ 52.00**



LINDNER Collection-/Presentation box for 12 Swiss pocket knives VICTORINOX\* models “Huntsman”, “Mountaineer”, “Tinker”, “Climber” and “Spartan”, Length 91 mm (folded up) as well as for other models in same size and type. Max. thickness of knife: approx. 27 mm  
**Format:** 236 x 303 x 40 mm

€ 2469  
**€ 52.00**

## NIMBUS DISPLAY FRAMES FOR SWISS POCKET KNIVES

Give your favourite collectibles that “special look” Details as well as the complete assortment of NIMBUS-Frames can be found on pages 106-107.



# COLLECTION BOX

## HEIGHT 40 mm – EXTRA SPACE FOR COLLECTORS SPECIAL WISHES!

Our collection boxes are so versatile. Many collectable items can be stored in any of the three different versions: minerals, decorations, medals, watches, jewellery, tin soldiers, pill boxes, valuable buttons and lighters, silver and gold items, precious vacation souvenirs and much more. The collection box comes in different lay-outs including movable dividers to adjust the individual compartments.

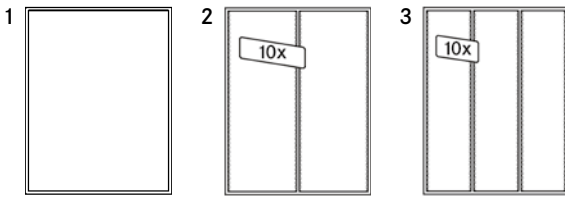

	COMPARTMENTS		Standard	Smoked glass
1	one large compartment	220 x 280 mm	2401	2461
2	with 2 compartments and 10 movable dividers	105 x 280 mm	2402	2462
3	with 3 compartments and 10 movable dividers	65 x 280 mm	2403	2463

COLLECTION BOX  
€ 46.50



FITTING CASES  
ON PAGE 22.

# ACCESSORIES

## DIVIDERS, FOR COLLECTION BOX



Format: 236 x 303 x 40 mm  
Max. filling height: 29 mm



Dividers, for collection box: long, red for collection box 2402, Pack of 10	2410	€ 8.50
Dividers, for collection box: short, red for collection box 2403, Pack of 10	2411	€ 8.50
Dividers, for collection box: long, dark red for collection box 2462, Pack of 10	2470	€ 8.50
Dividers, for collection box: short, dark red for collection box 2463, Pack of 10	2471	€ 8.50



LINDNER coin boxes, d-boxes and collection boxes can be mixed and stacked on top of each other. Only the height of each box is different!

## COLLECTION BOX FOR PINS / MEDALS / EMBLEMS

This collection box allows you to store your pins, medals, emblems, jewellery etc. in our famous LINDNER box systems, safely protected and always available for presenting your collections. The foam inserts with their velvet surface keep your collectibles safe at all times.

As with all LINDNER coin boxes, d-boxes or collection boxes, you can choose between a drawer in light grey or high-quality smoked glass. The transparent frame protects the collectibles while at the same time allowing a perfect view of your items. For the perfect presentation of your collectibles, you can choose between different coloured inserts of light red, blue or black. The collection box can hold collectibles with a height of max. 15 mm.

**Format:** 236 x 303 x 40 mm

**Max. filling height:** 15 mm

- |        |              |         |
|--------|--------------|---------|
| 🛒 2418 | Standard     | € 46.50 |
| 🛒 2458 | Smoked glass | € 46.50 |



## STACKABLE ASSORTMENT BOX WITH MOVABLE DIVIDERS

Easy to open by a convenient flap lid. With one fixed bridge. The two elongated compartments can be divided into 12 smaller compartments with the 10 dividers that are included. By means of 4 little feet and 4 corresponding slots in the cover the boxes can be easily stacked.

**Format:** 220 x 110 x 38 mm

**Internal height:** 33 mm

Made of transparent synthetic material with flexible compartments.

- |         |            |         |
|---------|------------|---------|
| 🛒 4820  | Per piece  | € 10.50 |
| 🛒 4820P | Pack of 10 | € 79.50 |



## STACKABLE ASSORTMENT BOX

Collecting box with hinged cover made from transparent synthetic material. Ideal for a collection of small items such as small figures, beads or fossils. The boxes are stackable and come in two different sizes.

**Format:** 190 x 99 x 22,5 mm

**Collecting Box  
with 6 fix compartments**

- |         |            |         |
|---------|------------|---------|
| 🛒 4821  | Per piece  | € 10.50 |
| 🛒 4821P | Pack of 10 | € 79.50 |

**Collecting Box  
with 12 fix compartments**

- |         |            |         |
|---------|------------|---------|
| 🛒 4822  | Per piece  | € 10.50 |
| 🛒 4822P | Pack of 10 | € 79.50 |



# ALU SHOWCASE

Useful height: max 35 mm. The showcase has strong metal reinforced corners and two locks. The lid with window can be opened 90°. Wall mounting is possible upright or diagonally.



Storage showcase made of aluminium with transparent synthetic insert with 45 compartments  
36 x 49 mm.  
€ 4890-45



Storage showcase made of aluminium with transparent synthetic insert with 24 compartments  
65 x 58 mm.  
€ 4890-24



Storage showcase made of aluminium with transparent synthetic insert with 12 compartments  
87 x 90 mm.  
€ 4890-12



Storage showcase made of aluminium with transparent synthetic insert with 6 compartments  
275 x 57 mm.  
€ 4890-6



Format:  
395 x 300 x 45 mm



ALU SHOWCASE  
€ 41.50

# EXPO - FLEXIBLE COLLECTION AND PRESENTATION SYSTEM

Versatile single modules made of stable acrylic glass with a folding front cover perfect to protect and display items including, model trucks, model cars, collectable toys, fossils, perfume miniatures.... and many other things.

Each single module has a standard bridge. Smaller objects can be presented on two levels. The standard bridge can be withdrawn allowing taller objects to be integrated into the display. With the help of the provided screws you can join

together several single modules in a simple and stable way making an attractive collection showcase while all individual modules remain accessible. The stable wall mount allows you to affix your collecting treasures safely onto a wall.

The wall mount can be connected with the single modules also with the help of the screws provided. However, screws to fix the wall mount onto the wall are not included in the delivery.  
Format: 400 x 100 x 60 mm



EXPO - Wall Mounter  
€ 4811

€ 19.50

EXPO - Single Module  
€ 4810

€ 24.50

EXPO - Set:  
3 Single modules  
+ 1 wall mounter  
€ 4812

€ 73.00



# COLLECTING, DISPLAYING, AND STORING WATCHES

## NERA VARIUS WATCH DISPLAY CASE

Timeless elegance, clean design, versatility, functionality, and above all a distinctive tactile feel are the defining features of our NERA series. The grained leather-look surface and the light decorative stitching give each case its own unique character and make it an eye-catching piece at all times. The base insert can be flexibly divided, allowing the display case to accommodate watches of different sizes while making optimal use of the available space.

**Format:** 300 x 244 x 80 mm



NERA VARIUS  
WATCH DISPLAY CASE

€ 82.50



- 2369-2402E-U
- 2369-2462E-U

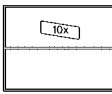

- 2369-2403E-U
- 2369-2463E-U

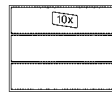

## NIMBUS DISPLAY FRAMES FOR WATCHES

Give your favourite collectables that "special look". Details as well as the complete assortment of NIMBUS-Frames can be found on pages 106-107.



## COLLECTION BOX FOR WATCHES

The collection box comes in different lay-outs including movable dividers to adjust the individual compartments. (see page 100)



Made  
in  
Germany

COLLECTION BOX

€ 46.50

# FOR THE STORAGE OF CHAMPAGNE LIDS



## CHAMPAGNE LID PAGES, PACK OF 5

Suited for 42 champagne lids each.  
 € 3502 € 29.00

## CHAMPAGNE LID ALBUM

Ring binder made of padded synthetic-foil incl. 5 champagne lid pages made of a sturdy, crystal clear synthetic material. Every page offers space for 42 champagne lids. The lids are inserted from the back into the page. The front of the capsule is protected all the time.

**Format:** 290 x 315 x 60 mm  
**Mechanism:** 4-ring, 80/80/80 mm  
**Scope of Delivery:** Ring binder, 5 Champagne lid pages.

	
3601	3504-S
€ 59.90	€ 26.50



**INSERT TRAY "ECO LUXE"**  
 Insert tray with transparent lid for 40 Champagne lids.  
**Format:** 298 x 205 x 10 mm  
**Pack of 2**

Made in Germany



INSERT TRAY "ECO LUXE"  
**€ 13.50** ● 3510P

**CARUS-4**  
 Solid Wood Case CARUS-4 for 192 Champagne lids.  
 (see page 29)

Made in Germany



CARUS-4  
**€ 95.50** ● 2494-6 ● 2494-6M



**SOLID WOOD COIN CASE**  
 Solid Wood Coin Case for 240 Champagne lids.  
 (see page 30)

Made in Germany



SOLID WOOD COIN CASE  
**€ 69.50** ● S2495-S2148CE ● S2495-S2148ME



**CHAMPAGNE LID BOX**  
 (see page 8)

Made in Germany



CHAMPAGNE LID BOX  
**€ 25.50** ● 2148F ● 2748F

**NERA CASE M PLUS - WITH WINDOW**  
 NERA Case M PLUS - with window for 48 Champagne lids.  
 (see page 26)



NERA M  
**€ 51.50** ● 2367-2148E ● 2367-2748E ● 2367-2148ME ● 2367-2148CE

**COIN CASE ALU**  
 Coin case ALU incl. 5 trays for 240 Champagne lids.



COIN CASE ALU  
**€ 59.50** ● S2307-CHM ● S2307-CHC

\* Delivery only while stocks last.

Prices do not include contents / display material. All prices and specifications are subject to change without prior notice.

## KARAT COIN ALBUM FOR "JETONS TOURISTIQUES"

High-quality, ring binder made of padded synthetic foil. Comes with 5 karat-coin pages (Order no. K2) and 5 white interleaves.

**Pack of 5 karat-coin pages**  
Paper interleaves, white, neutral.  
☞ K2W € 12.50

**Format Ring binder:** 210 x 230 x 30 mm  
**Mechanism:** 4-ring, 45/65/45 mm

**Capacity:**  
10 karat-coin pages K2  
(for a total of 120 "Jetons Touristiques")

☞ 1106JT € 33.50



Made in Germany

**Karat**

Other karat-pages see page 32.

## ACCESSORIES FOR "JETONS TOURISTIQUES"



### MATCHING COIN CAPSULES

Coin capsules 34,5 mm (Interior Ø)

Pack of 10  
☞ 2250345P

Pack of 100  
☞ 2251345



Pack of 10

€ 5.50

Pack of 100

€ 41.50

### COIN BOX FOR 24 "JETONS TOURISTIQUES" IN CAPSULES (see page 6)

Made in Germany



COIN BOX

€ 25.50

● 2224  
● 2624

### NERA XL

NERA Case XL for 72 "Jetons Touristiques" in capsules (delivery without capsules). (see page 27)



NERA XL

€ 86.50

● 2365-2224E  
● 2365-2624E



### NERA M

NERA Case M for 24 "Jetons Touristiques" in capsules (delivery without capsules). (see page 26)



NERA M

€ 49.50

● 2364-2224E  
● 2364-2624E



### COIN BOX FOR 30 "JETONS TOURISTIQUES" (see page 4)

Made in Germany



COIN BOX

€ 25.50

● 2150  
● 2750

### NERA XL

NERA Case XL for 90 «Jetons Touristiques». (see page 27)



NERA XL

€ 86.50

● 2365-2150E  
● 2365-2750E



### NERA M

NERA Case M for 30 "Jetons Touristiques". (see page 26)



NERA M

€ 49.50

● 2364-2150E  
● 2364-2750E



# NIMBUS DISPLAY FRAMES

## GIVE YOUR FAVOURITE COLLECTIBLES THAT "SPECIAL LOOK"

The display frames of the NIMBUS Series offer a completely new way of displaying your collectibles. The special feature of these frames are the two crystal clear, flexible silicone membranes which surround your items gently and create the impression that they are suspended inside the frame. At the same time you have an unlimited view of the back and front side of your favorite pieces. There is almost no limit of what kind of items you can

display in these frames. The material is very flexible and adapts completely to the surface of the objects and keeps them in place. From coins (in capsules) and stamps to writing utensils, watches, knives, decorations, photos, jewellery and other collectibles - with NIMBUS you can display your favourite objects in a special 3D frame!

**Special production from 10.000 pieces.**  
**Embossing possible from 100 pieces.**



### ...HERE IS HOW IT WORKS:

Open the frame completely. Place the collectible on one of the two silicone membranes and close the frame. The object will be held in place by the surrounding silicone membranes, keeping it in its position. A magnetic closure holds the frame together!



**NIMBUS 50**  
 Internal: 50 x 50 mm  
 External: 80 x 85 x 35 mm  
 ● 4828 black  
 € 17,50

**NIMBUS 70**  
 Internal: 70 x 70 mm  
 External: 100 x 105 x 35 mm  
 ● 4830 black  
 ○ 4850 white  
 € 17,50

**NIMBUS 100**  
 Internal: 100 x 100 mm  
 External: 130 x 135 x 35 mm  
 ● 4839 black  
 € 25,00

**NIMBUS 150**  
 Internal: 150 x 150 mm  
 External: 180 x 185 x 35 mm  
 ● 4838 black  
 € 35,00  
 ● 4868\* Crocodile look, red  
 ● 4878\* Wood tone, brown  
 € 9,50

\*Delivery only while stocks last.

Prices do not include contents / display material. All prices and specifications are subject to change without prior notice.



5

5

4

4

NEMO

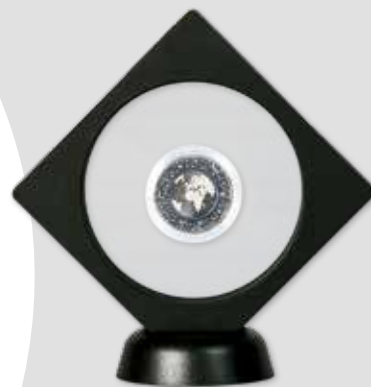

**NIMBUS NEMO**  
with round cutout Ø 75 mm  
External: 90 x 90 x 20 mm  
Inner diameter: 75 mm  
● 4833 black  
€ 17.50

ECO



**NIMBUS ECO 70**  
Internal: 70 x 70 mm  
External: 100 x 100 x 25 mm  
● 4835-S black  
€ 14.50

**NIMBUS ECO**  
Material: Synthetic.  
With snap-lock.



5



6

**NIMBUS 230**  
Internal: 230 x 180 mm  
External: 270 x 225 x 45 mm  
● 4831 black  
○ 4851 white  
€ 39.50

**NIMBUS 265**  
Internal: 265 x 60 mm  
External: 295 x 95 x 35 mm  
● 4832 black  
○ 4852 white  
€ 31.50



**NIMBUS ECO 100**  
Internal: 100 x 100 mm  
External: 130 x 130 x 25 mm  
● 4836-S black  
○ 4836-WS white  
● 4836-B blue  
€ 15.50



**NIMBUS ECO 150**  
Internal: 150 x 150 mm  
External: 180 x 180 x 25 mm  
● 4837-S black  
€ 25.00

# UV TEST LAMPS

Banknotes, stamps, telephone cards and other documents are easily detected with a UV lamp. The UV lamp will show whether a stamp has been printed on normal paper or fluorescent paper. Fluorescent paper gives off

a light yellow or white glow compared to normal paper. Repairs and other defects can also be seen. The lamp will operate in daylight or artificial light.

## UV-LAMP (long-wave) with rechargeable battery

With the UV lamp, banknotes, stamps or credit Cards can be checked for their security Features.

Inspection lamp with 2 functions: UV LED longwave 365 nm and 395 nm, and white and warm LED light, each with 2 brightness levels. Additionally, it can be dimmed steplessly.

Format 153 x 30 mm.

Weight: approx. 160 g.

**Scope of Delivery:** UV-lamp, USB charging cable

₹ 57199 € 52.50

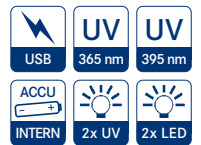

## UV-LAMP (long-wave)

For fluorescence detection / 365 nm. With flashlight function and fold-out stand. Without batteries. 4x AA are required.

Format: 160 x 55 x 25 mm

₹ 7081 € 17.50



## UV-LAMP (short-wave)

For fluorescence detection / 254 nm. With flashlight function and fold-out stand. Without batteries. 4x AA are required.

Format 165 x 58 x 25 mm ₹ 7084 € 39.50

Replacement Tube, for Order no. 7084. ₹ 7081001 € 23.50



Phosphor lamp

## UV/LED MAGNIFIER with rechargeable battery

For checking banknotes, ID cards and other documents. Extremely handy and hands-free magnifying glass with bright LED light and UV light. The USB charging function makes it easy to charge the battery and saves you the hassle of changing batteries.

**Scope of Delivery:** UV/LED magnifying glass, transport case, cleaning cloth, 2 measuring scales, USB charging cable.

**Technical data:**

Double lens with 30x magnification and 2 interchangeable measuring scales. 2 LED modes (LED and UV), incl. transport case, cleaning cloth, USB charging cable. Magnifying glass dimensions: 55 x 55 mm.

₹ 57192 € 49.50

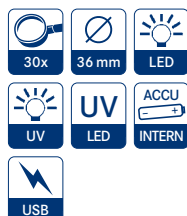

## UV- FLASHLIGHT

UV- Flashlight with 9 UV-LEDs: For fluorescence detection and testing of e.g. Banknotes, Stamps and for identification of everything that is only visible under UV-light. Without batteries. 3x AAA are required. Length: approx. 85 mm

₹ 57189 € 14.50



## MULTIFUNCTIONAL TESTER

FOR BANKNOTES, STAMPS, CREDIT CARDS, CHECKS ETC.

Fluorescence detection by UV-light and watermark detection by white light from bottom plate, incl. measuring scale. Magnetic sensor with optical and acoustic signal to detect magnetic security features. Window in the lid with magnifying glass 50,5 x 35 mm. Power supply via USB (USB charging cable included).

Format: 200 x 105 x 105 mm

☛ S7085 € 64.50



## DIGIMICROSCOPE FLEX

The DigiMicroscope Flex impresses with its versatility. It can be used as a handheld microscope or on the enclosed flexible stand with suction cup. Thus it can be placed in any conceivable position. Objects and surfaces can be viewed directly on the PC, tablet or Smartphone. Photos can be taken separately or in programmable intervals. There is also the possibility to record videos.

☛ S66144 € 110.00

**Technical data:**  
Resolution: 1600 x 1200 pixel (UXGA)  
Video resolution: 640 x 480 pixel (VGA)  
Magnifications: 60x, 250x  
Picture format: JPEG (picture)  
Video format: AVI (video)  
Lighting: 4 dimmable LEDs  
System Requirements:  
Windows: XP, Vista, 7, 8, 10 (32&64bit);  
Mac OS X: 10.5.6 and higher,  
Android 4.3 and higher.  
Connection/Power supply: USB 2.0 /  
USB-OTG

Scope of delivery: Flexible tripod  
with suction cups, with grid,  
software-CD, manual

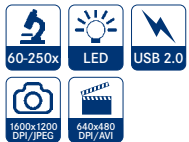

## DIGIMICROSCOPE PROFESSIONAL

With the reflecta DigiMicroscope Professional, you can view objects or capture images and videos onto a microSD memory card. The integrated LCD display and the built-in Li-ion battery make the microscope a portable research lab. The device with AV-out offers the most versatile use, e.g. measuring and investigating the tiniest objects or surfaces.

Format: 230 x 150 x 110 mm

☛ S66134 € 246.50

**Technical data:**

Resolution: 5.0 megapixels  
(12 megapixels interpolated)  
Video resolution: VGA, QVGA  
Magnification: 20x-200x (optical),  
up to 500x (digital)  
Image format: JPEG, BMP  
Video format: AVI  
LCD display: 3.5 inch format 4:3  
Lighting: 8 LEDs  
System requirements: Windows, XP,  
Vista, 7, 8, 10 / Mac 10.6 - 10.13  
Power supply: Li-ion battery 3.7 V/800 mA  
or adapter (battery operating time: 2 hours  
battery charging time: 4 hours)  
Connections: USB 2.0, microSD card slot,  
AV output

Scope of delivery: digital microscope,  
adapter, Li-ion battery, USB cable, TV cable,  
user manual, software CD, cleaning cloth

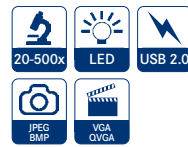

Usable  
without  
computer!

## LED LIGHT PAD

Handy and portable LED Light Pad for testing e.g. stamps and banknotes on damage, watermarks and security features. The LED technology ensures one uniform light distribution over the whole light field. Delivery without batteries (requires 6x AAA), including bag for storage. Format: 155 x 150 x 14 mm (Illuminated field: 125 x 100 mm)

☛ S10311 € 99.50

SET: LED Light Pad including power supply

☛ S10311-SET € 119.50



# MAGNIFIERS



**Rimless Standing Magnifier with LED Illumination**  
 Magnification: 2x / 6x (Incorporated lens 6x),  
 Diameter of the lens: 90 mm.  
 Flexarm: approx. 170 mm, Feet: approx. 190 x 165 mm.  
 Incl. batteries.

€ 15.50



**Aluminium LED Magnifier**  
 Magnification: 10x, Diameter of the lens: 30 mm.  
 LED Magnifier in an aluminium design, viewing pane with a scale of 20 x 20 mm.  
 Supplied in a padded case, without batteries.

€ 31.50



**Rimless, aspheric LED Magnifier**  
 Magnification: 3x / 5x, Diameter of the lens: 90 mm.  
 The high-quality aspheric lens provides a clear picture without the typical distortion.  
 Adjustable LED.  
 Without batteries.

€ 15.50



**LED Magnifier**  
 Magnification: 5x, Diameter of the lens: 65/90 x 50 mm.  
 Simply touch the silver ring of the magnifier to turn the LED-light on/off.  
 Supplied with a padded black case, batteries are included.

€ 30.00



**Rimless LED Illuminated Magnifier**  
 Magnification: 8x / 20x (Incorporated lens with 20x magnification),  
 Diameter of the lens: 90 mm.  
 Incl. lens protective bag, without batteries.

€ 27.00



**Folding Magnifier**  
 Magnification: 10x,  
 Diameter of the lens: 21 mm.

€ 13.50



**Folding Magnifier with LED lighting**  
 Magnification: 10x,  
 Diameter of the lens: 25 mm.

€ 17.50



**Stand Magnifier**  
 Magnification: 10x,  
 Diameter of the lens: 25 mm.

€ 10.00



**Folding Magnifier as Key-holder**  
 Magnification: 5x,  
 Diameter of the lens: 20 mm.

€ 10.00



**Rimless LED Illuminated Magnifier**

Magnification: 2,5x / 4x (Incorporated lens with 4x magnification), Diameter of the lens: 110 mm. Incl. lens protective bag, without batteries.

☛ S7131

€ 8.00

Magnification: 3x / 4,5x, (Incorporated lens with 4,5x magnification), Diameter of the lens: 90 mm.

Incl. lens protective bag, without batteries.

☛ S7130

€ 10.00



**Rimless Handle Magnifier**

Magnification: 2x, Diameter of the lens: 90 mm.

Incl. lens protective bag. ☛ 7195

€ 7.50

Magnification: 3x, Diameter of the lens: 75 mm.

Incl. lens protective bag. ☛ 7196

€ 8.50

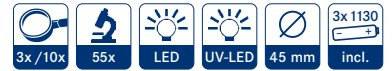

**Multipurpose-LED Magnifier**

Magnification: 3x / 10x / 55x (Microscope 55x with light),

Format: 115 x 40 x 25 mm.

LED Magnifier incl. flashlight with 3 white LEDs. 1 white LED for the magnifier.

With integrated UV-lamp.

Incl. batteries.

☛ S7159-S

€ 15.00



**LED Pocket Illuminated Magnifier**

Magnification: 2,5x, Format: 60 x 32 mm (closed).

By pushing out the lens the LED illumination of the LED is automatically activated.

Incl. batteries.

☛ S7134

€ 9.50



**Rimless LED Illuminated Magnifier**

Magnification: 2x, Diameter of the lens: 90 mm.

Incl. lens protective bag made of grey velour, batteries included.

☛ 7152

€ 17.50



**Metal Linen Tester with LED**

Magnification: 10x, Diameter of the lens: 27 mm. Robust metal linen tester with lighting and scale 25 x 25 mm. Incl. batteries.

☛ S30

€ 31.00



**Metal Linen Tester**

Grossissement: 8x Diameter of the lens: 30 mm, With scale, field of view 25 x 25 mm.

☛ S38

€ 11.50



**LED Illuminated Magnifier, blue**

Magnification: 5x, Diameter of the lens: 50 mm. Incl. batteries.

☛ S198-B

€ 6.50



**ESCHENBACH**  
Bright Field Magnifier

Magnification: 1,8x,  
Diameter of the lens: 65 mm.

Bright field magnifiers intensify and gather available light, thus brightening the viewing area. A magnification is possible if the distance between eye and magnifier is adjusted. This visual aid fits in every pocket! Glass magnifier with matte edge.

🔍 1.8x 📏 65 mm

🛒 7180 € 120.00



**ESCHENBACH**  
Compact Pocket Magnifier with LED light

Made in Germany

Magnification: 4x,  
Format: 86 x 54 mm.

easyPocket – up close and detailed! This handy magnifier can be taken anywhere.

🔍 4x 💡 LED 🔋 1x 2025 incl.

🛒 7184 € 103.00



**ESCHENBACH**  
Technical folding Magnifier mobilent

Made in Germany

Magnification: 10x, Diameter of the lens: 35 mm. The ideal magnifier for handbag and trouser pocket or for wearing around the neck. With neck cord.

E1520910

🔍 10x 📏 35 mm 💡 LED 🔋 1x 2032 incl.

🛒 E1710910 € 43.50

**ESCHENBACH Technical folding Magnifier mobilent LED**

Magnification 10x, Diameter of the lens: 35 mm. The ideal illuminated magnifier for when you're on the move: high-magnification, small and handy; suitable for wearing around the neck, for use as a hand-held magnifier and fits in a trouser pocket. With neck cord.

🛒 E1520910 € 69.00



**ESCHENBACH**  
Linen Tester

Made in Germany

Precision quality linen tester, brass casing, silky-matte, chrome-plated finish. Lens: Biconvex, optically ground silicate glass.

Magnification: 10x, Field of view 15 x 15 mm, 14,6 mm lens, height 27 mm.

🛒 7176 € 68.00



**ESCHENBACH**  
Plastic Linen Tester

Made in Germany

Linen tester in 3 sizes with imprinted scale on the side of the stand.

Magnification: 10x, Field of view 15 x 15 mm, Lens Ø 12 mm, height 28 mm.

🛒 7197 € 30.50



**ESCHENBACH**  
Magnifying Glasses MaxDetail

Made in Germany

Precise viewing of collectibles while keeping your hands free. 2x magnification, weighing 49 g. Field of vision: 130 mm/400 mm, working area approx. 400 mm. Diopter compensation ± 3.0 dpt, adjustable on the right and left. Comes with a convenient case.

🔍 2x

🛒 7169 € 158.50



**ESCHENBACH**  
Approved, technical folding Magnifier

Made in Germany

Approved, technical folding magnifiers. Matte, chrome-plated brass casing with loop, black metal lens frame and precision cut glass.

Magnification: 10x,  
Diameter of the lens: 21 mm.

🛒 7170 Aplanat € 82.50

Magnification: 12x,  
Diameter of the lens: 15 mm.

🛒 7179 Aplanat € 84.00

Magnification: 20x,  
Diameter of the lens: 17 mm.

🛒 7172 Achromat € 151.50



**ESCHENBACH**  
Stand Magnifier

Made in Germany

Magnification: 8x,  
Diameter of the lens: 25 mm.

Material: plastic  
Lens: aplanatic PXM® – lightweight, distortion-free lens with cera-tec protective coating.

🔍 8x 📏 25 mm

🛒 7166 € 45.50

**ESCHENBACH Magnifier**

Magnification: 15x,  
Diameter of the lens: 15 mm.

Material: with air vent to resist condensation. PXM® lens, 2 lenses.

🛒 7167 € 50.50



**ESCHENBACH**  
Illuminated Pocket Magnifiers Mobilux with LED

Magnification: 5x,  
Diameter of the lens: 58 mm. Incl. batteries

🔍 5x 💡 LED 🔋 2x AA incl.

🛒 7121 € 108.00

Magnification: 7x,  
Diameter of the lens: 35 mm. Incl. batteries

🔍 7x 📏 12,5x 💡 LED 🔋 2x AA incl.

🛒 7122 € 95.50

Magnification: 12,5x,  
Diameter of the lens: 35 mm. Incl. batteries

🔍 12,5x 💡 LED 🔋 2x AA incl.

🛒 7123 € 107.00

Magnification: 4x,  
Format: 75 x 50 mm (rectangular lens). Incl. batteries

🔍 4x 💡 LED 🔋 2x AA incl.

🛒 7126 € 124.50

Made in Germany

**ESCHENBACH Illuminated Pocket Magnifiers Mobilux with LED**  
Aspheric PXM®-light weight lens, hard-coated on both sides with cera-tec.

# LINDNER ILLUSTRATED COUNTRY PAGES AND SUPPLEMENTS

## ILLUSTRATED PAGES

Illustrated pages provide a full and complete overview of each country's issued stamps. LINDNER uses an acid-free, age resistant, and archival paper called "PERMAPHIL®"; the size is 272 x 296 mm. The firm, wood-free paper has an 18-hole perforation to fit all the original LINDNER 18-ring binders shown on pages 72-74.

Some of the illustrated albums are available in colour. These are marked in the following tables.

## SUPPLEMENTS

Listed from page 125 are the yearly supplements for all LINDNER-T illustrated country albums. They are published in the early summer of each year and contain the supplement pages for all stamps issued in the previous calendar year. Stamp collections can be kept up-to-date and the continuous quality of the supplements guarantee a perfect match to the pages previously purchased.

## NUMBER OF PAGES

In the following index, the number of pages is the actual amount of illustrated album pages in one set (title pages excluded). However, all sets contain title pages and are included in the price.

## LINDNER SINGLE PAGE INDEX

The page index lists the year as well as the MICHEL numbers and/or the catalog numbers for each illustrated page. The LINDNER-T page indexes starting in January 2000 can be found on the internet under [www.lindner-original.de/en](http://www.lindner-original.de/en) in the section "Flyers & Brochures". For each area of interest you can obtain the retrospective years on request.

## IMPORTANT:

The following tables contain the supplement pages 2024. The supplements for 2025 will be issued in spring 2026.

## SINGLE PAGES

Every LINDNER-T illustrated album page can be purchased individually. Please provide exact order information including album number, page number and year since single pages can not be exchanged or returned. Example: 1 x 120b-49 pages 15, 16, 17 year 1959. We recommend before purchasing a large amount of single pages, check if it is less expensive to obtain a complete set instead of individual years. Please contact us if you need assistance.

## ADVANTAGE OFFER

### LINDNER T-ILLUSTRATED PAGES + RING BINDER SET REGULAR AT A SPECIAL PRICE!

#### TAKE ADVANTAGE OF THIS COMPLETE OFFER!

When purchasing a LINDNER T-illustrated set of pages, which is marked with "☺" on the following pages, we can offer you the possibility to buy the ring binder set REGULAR at a price saving.

#### GET THE BEST DEAL:

Select illustrated album with ☺, choose the colour of the ring binder set (Order no. 1124V) of your choice - and include both order numbers when placing your order.

This will result in a price advantage compared to the purchase of the pages and ring binder set normally.



Ring binder and slipcase

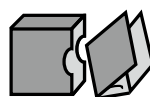

1124V - G

1124V - S

1124V - B

1124V - H

1124V - W

Order no.  
LINDNER T-  
Illustrated  
Country Albums

Order this offer and

**SAVE!**

The popular ring binder set REGULAR is available in the colours winered, tan, blue, black and green. Details for the ring binder set Regular are found on page 72.

Country	in colour	Period	Number of Pages		Price (pages only) €
<b>ABU DHABI</b>					
		1964 - 1972	7	167	19.60
<b>ÅLAND ISLANDS</b>					
		1984 - 2015	48 ☺	129A	134.40
	●	2016 - 2024	22	129A-16	61.60
<b>ALDERNEY</b>					
		1983 - 2011	48 ☺	145GA	134.40
		2012 - 2023	48 ☺	145GA-12	134.40
<b>ANDORRA</b>					
Spanish		1928 - 2015	51 ☺	123	142.80
	●	2016 - 2024	25 ☺	123-16	70.00
French		1931 - 1971	23	124	64.40
		1972 - 2007	47 ☺	124A	131.60
		2008 - 2024	36 ☺	124A-08	100.80
<b>ARGENTINA</b>					
		1858 - 1951	38 ☺	460-58	106.40
		1952 - 1969	39 ☺	461-52	109.20
		1970 - 1977	27 ☺	461	75.60
		1978 - 1984	44 ☺	461-78	123.20
		1985 - 1991	51 ☺	461-85	142.80
		1992 - 1998	41 ☺	461-92	114.80
		1999 - 2003	43 ☺	461-99	120.40
		2004 - 2007	37 ☺	461-04	103.60
<b>ARMENIA</b>					
		1992 - 2002	28 ☺	255	78.40
<b>ARUBA</b>					
		1986 - 2010	52 ☺	431	145.60
		2011 - 2024	48 ☺	431-11	134.40
<b>AUSTRALIA</b>					
		1913 - 1965	25 ☺	470	70.00
		1966 - 1982	38 ☺	470-66	106.40
		1983 - 1991	43 ☺	470-83	120.40
		1992 - 1997	42 ☺	470-92	117.60
		1998 - 2003	48 ☺	470-98	134.40
		2004 - 2006	47 ☺	470-04	131.60
		2007 - 2009	47 ☺	470-07	131.60
		2010 - 2012	53 ☺	470-10	148.40
		2013 - 2014	38 ☺	470-13	106.40
		2015 - 2016	47 ☺	470-15	131.60
	●	2017 - 2018	47 ☺	470-17	131.60
	●	2019 - 2020	48 ☺	470-19	134.40
	●	2021 - 2022	46 ☺	470-21	128.80
	●	2023 - 2024	49 ☺	470-23	137.20
<b>AUSTRALIAN ANTARCTIC TERRITORY</b>					
		1957 - 2024	48 ☺	471	134.40
<b>AUSTRIA</b>					
<b>Previous to 1945</b>					
Bosnia and Herzegovina		1879 - 1918	12	202	33.60
Lombardei and Venetia, Crete, Levante		1850 - 1918	21	203	58.80
Austria-Hungarian Monarchy		1850 - 1918	22	204	61.60
German-Austrian Republic		1918 - 1921	12	205	33.60
Austrian Republic		1922 - 1937	26 ☺	206	72.80
Austria during the 3rd Reich, Ostmark		1938 - 1945	19	206-38	53.20
<b>Austria</b>					
Complete offer*	●	1945 - 2024	375 ☺	209S	787.50
Austrian Republic		1945 - 1967	53 ☺	207	148.40
		1968 - 1974	25 ☺	208	70.00
	●	1975 - 1984	34 ☺	209	95.20
	●	1985 - 1995	42 ☺	209-85	117.60
	●	1996 - 2006	53 ☺	209-96	148.40
	●	2007 - 2011	45 ☺	209-07	126.00
	●	2012 - 2016	47 ☺	209-12	131.60
	●	2017 - 2021	47 ☺	209-17	131.60
	●	2022 - 2024	29 ☺	209-22	81.20

Country	in colour	Period	Number of Pages		Price (pages only) €
<b>Sheetlets</b>					
		1988 - 2008	51 ☺	209K	142.80
		2009 - 2014	48 ☺	209K-09	134.40
		2015 - 2021	51 ☺	209K-15	142.80
	●	2022 - 2024	25 ☺	209K-22	70.00
<b>Booklets</b>					
		2011 - 2023	26 ☺	209H-11	72.80
<b>Self-adhesive panes</b>					
		2005 - 2023	27 ☺	209FS	75.60
<b>Dispenser Stamps</b>					
	●	2017 - 2024	15	209D-17	42.00
<b>Vending machine stamps</b>					
		1983 - 2017	51 ☺	209AS	142.80
	●	2018 - 2024	37 ☺	209AS-18	103.60
<b>Neutral page for 24 vending machine stamps</b>					
			1	209ASN	5.80
<b>Personalized Issues of the OSD</b>					
Personalized single stamps of the OSD		2005 - 2024	20	209PM-E	56.00
Personalized sheets of the OSD		2005 - 2011	68 ☺	209PM-B	190.40
		2012 - 2014	48 ☺	209PM-B-12	134.40
		2015 - 2017	65 ☺	209PM-B-15	182.00
	●	2018 - 2019	49 ☺	209PM-B-18	137.20
	●	2020 - 2021	48 ☺	209PM-B-20	134.40
	●	2022 - 2023	46 ☺	209PM-B-22	128.80
Neutral page for 12 personalized stamps in horizontal format			1	209PM1	5.80
Neutral page for 12 personalized stamps in vertical format			1	209PM2	5.80
<b>AZERBAIJAN</b>					
		1992 - 1997	43 ☺	258	120.40
		1998 - 2003	21	258-98	58.80
<b>AZORES</b>					
Postal independence		1980 - 2007	48 ☺	222	134.40
		2008 - 2024	36 ☺	222-08	100.80
Sheetlets		1989 - 2024	23	222K	64.40
Booklets		1981 - 2015	15	222H	42.00
<b>BAHAWALPUR</b>					
		1945 - 1949	5	509B	14.00
<b>BANGLADESH</b>					
		1971 - 1990	45 ☺	507	126.00
		1991 - 2000	47 ☺	507-91	131.60
		2001 - 2004	10	507-01	28.00
<b>BELARUS</b>					
		1992 - 2001	45 ☺	242	126.00
		2002 - 2010	52 ☺	242-02	145.60
		2011 - 2016	52 ☺	242-11	145.60
	●	2017 - 2020	49 ☺	242-17	137.20
	●	2021 - 2024	54 ☺	242-21	151.20
<b>BELGIUM</b>					
		1849 - 1939	47 ☺	125	131.60
		1940 - 1944	22	126	61.60
		1944 - 1956	34 ☺	127	95.20
		1957 - 1964	33 ☺	127-57	92.40
		1965 - 1971	32 ☺	127A	89.60
		1972 - 1980	42 ☺	127B	117.60
		1981 - 1989	40 ☺	127-81	112.00
		1990 - 1997	42 ☺	127-90	117.60
		1998 - 2003	48 ☺	127-98	134.40
		2004 - 2006	42 ☺	127-04	117.60
		2007 - 2009	44 ☺	127-07	123.20
		2010 - 2014	52 ☺	127-10	145.60
		2015 - 2017	42 ☺	127-15	117.60
	●	2018 - 2020	42 ☺	127-18	117.60
	●	2021 - 2024	52 ☺	127-21	145.60
Official-Registered, Postage due, Parcel Post, Military and Railway Parcel stamps plus Booklets		1940 - 2001	46 ☺	126R	128.80
Parcel Post and Railway Parcel stamps plus Booklets		2002 - 2015	51 ☺	126R-02	142.80
Booklets	●	2016 - 2024	10	126R-16	28.00

\* Partly in black/white. ☺ = Take advantage of our complete offers see page 113.

Country	in colour	Period	Number of Pages		Price (pages only) €
<b>BOPHUTHATSWANA</b>					
		1977 - 1994	32 ☺	518	89.60
<b>BOSNIA-HERZEGOVINA</b>					
		1993 - 2008	56 ☺	173	156.80
		2009 - 2015	22	173-09	61.60
<b>BRAZIL</b>					
		1942 - 1967	53 ☺	479	148.40
		1967 - 1974	40 ☺	480	112.00
		1975 - 1981	39 ☺	480-75	109.20
		1982 - 1986	38 ☺	480-82	106.40
		1987 - 1993	44 ☺	480-87	123.20
		1994 - 2000	46 ☺	480-94	128.80
		2001 - 2007	41 ☺	480-01	114.80
<b>BRITISH ANTARCTIC TERRITORIES</b>					
		1963 - 2008	51 ☺	405	142.80
		2009 - 2024	46 ☺	405-09	128.80
<b>BULGARIA</b>					
		1945 - 1955	47 ☺	135	131.60
		1956 - 1962	41 ☺	135-56	114.80
		1963 - 1966	37 ☺	135-63	103.60
		1967 - 1970	40 ☺	135-67	112.00
		1971 - 1975	51 ☺	136A	142.80
		1976 - 1979	51 ☺	136-76	142.80
		1980 - 1983	51 ☺	136-80	142.80
		1984 - 1986	43 ☺	136-84	120.40
		1987 - 1990	45 ☺	136-87	126.00
		1991 - 1997	52 ☺	136-91	145.60
		1998 - 2006	52 ☺	136-98	145.60
		2007 - 2008	13	136-07	36.40
<b>CANADA</b>					
		1851 - 1952	27 ☺	500	75.60
		1953 - 1971	17	500-53	47.60
		1972 - 1982	37 ☺	500A	103.60
		1983 - 1991	43 ☺	500-83	120.40
		1992 - 1997	45 ☺	500-92	126.00
		1998 - 2002	49 ☺	500-98	137.20
		2003 - 2008	52 ☺	500-03	145.60
		2009 - 2012	54 ☺	500-09	151.20
		2013 - 2015	51 ☺	500-13	142.80
	●	2016 - 2018	47 ☺	500-16	131.60
	●	2019 - 2024	53 ☺	500-19	148.40
<b>CHILE</b>					
		1960 - 1985	43 ☺	505	120.40
		1986 - 1991	39 ☺	505-86	109.20
		1992 - 1998	44 ☺	505-92	123.20
		1999 - 2001	19	505-99	53.20
<b>CHINA - TAIWAN (FORMOSA)</b>					
		1945 - 1960	37 ☺	164-45	103.60
		1960 - 1969	39 ☺	164-60	109.20
		1970 - 1975	36 ☺	164-70	100.80
		1976 - 1981	38 ☺	164-76	106.40
		1982 - 1988	45 ☺	164-82	126.00
		1989 - 1994	47 ☺	164-89	131.60
		1995 - 2000	44 ☺	164-95	123.20
		2001 - 2006	61 ☺	164-01	170.80
		2007 - 2008	19	164-07	53.20
<b>CHINA, PEOPLE'S REPUBLIC</b>					
		1949 - 1959	50 ☺	159	140.00
		1960 - 1965	47 ☺	159-60	131.60
		1966 - 1976	42 ☺	159-66	117.60
		1977 - 1980	44 ☺	159-77	123.20
		1981 - 1986	55 ☺	159-81	154.00
		1987 - 1991	45 ☺	159-87	126.00
		1992 - 1996	47 ☺	159-92	131.60
		1997 - 2000	41 ☺	159-97	114.80
		2001 - 2004	44 ☺	159-01	123.20
		2005 - 2008	50 ☺	159-05	140.00
		2009 - 2011	46 ☺	159-09	128.80

Country	in colour	Period	Number of Pages		Price (pages only) €
		2012 - 2014	49 ☺	159-12	137.20
		2015 - 2017	48 ☺	159-15	134.40
	●	2018 - 2020	48 ☺	159-18	134.40
	●	2021 - 2023	45 ☺	159-21	126.00
<b>CHRISTMAS ISLANDS</b>					
		1958 - 1996	46 ☺	474	128.80
		1997 - 2016	50 ☺	474-97	140.00
	●	2017 - 2024	31 ☺	474-17	86.80
<b>CISKEI</b>					
		1981 - 1994	30 ☺	524	84.00
<b>COCOS (KEELING) ISLANDS</b>					
		1963 - 2012	50 ☺	475	140.00
		2013 - 2024	19	475-13	53.20
<b>COMORO ISLANDS</b>					
		1950 - 1975	17	130C	47.60
<b>CROATIA</b>					
		1941 - 1945	25 ☺	168-41	70.00
Republic		1991 - 2002	45 ☺	168	126.00
		2003 - 2012	47 ☺	168-03	131.60
		2013 - 2019	51 ☺	168-13	142.80
	●	2020 - 2024	33 ☺	168-20	92.40
Sheetlets		1943 - 1945	20	168K-43	56.00
		1993 - 2007	48 ☺	168K	134.40
		2008 - 2011	45 ☺	168K-08	126.00
		2012 - 2014	44 ☺	168K-12	123.20
		2015 - 2017	49 ☺	168K-15	137.20
	●	2018 - 2019	43 ☺	168K-18	120.40
	●	2020 - 2021	42 ☺	168K-20	117.60
	●	2022 - 2024	46 ☺	168K-22	128.80
Obligatory Tax stamps - dentated		1991 - 2008	11	168ZA	30.80
Postal tax stamps - perforated issues - sheetlets		1994	2	168ZAK	5.60
<b>CROATIAN REPUBLIC/HERCEG-BOSNA BOSNIA-HERZEGOVINA</b>					
		1993 - 2014	51 ☺	168BH	142.80
		2015 - 2024	32 ☺	168BH-15	89.60
<b>CURAÇAO</b>					
		1873 - 1949	22	429	61.60
<b>CYPRUS</b>					
		1880 - 1955	11	294	30.80
		1960 - 1971	20	295	56.00
		1972 - 1984	28 ☺	295A	78.40
		1985 - 2003	46 ☺	295-85	128.80
		2004 - 2019	48 ☺	295-04	134.40
	●	2020 - 2024	12	295-20	33.60
Turkish Cypriot Post		1974 - 1996	48 ☺	298	134.40
		1997 - 2018	48 ☺	298-97	134.40
	●	2019 - 2024	7	298-19	19.60
<b>CZECH REPUBLIC</b>					
		1993 - 2004	48 ☺	312-93	134.40
		2005 - 2013	49 ☺	312-05	137.20
		2014 - 2019	49 ☺	312-14	137.20
	●	2020 - 2024	55 ☺	312-20	154.00
<b>CZECHOSLOVAKIA</b>					
		1918 - 1939	40 ☺	309	112.00
		1945 - 1952	37 ☺	310	103.60
		1953 - 1959	40 ☺	310-53	112.00
		1960 - 1964	34 ☺	310-60	95.20
		1965 - 1967	27 ☺	311	75.60
		1968 - 1971	32 ☺	312	89.60
		1972 - 1979	57 ☺	312A	159.60
		1980 - 1984	37 ☺	312-80	103.60
		1985 - 1989	44 ☺	312-85	123.20
		1990 - 1992	12	312-90	33.60

Country	in colour	Period	Number of Pages		Price (pages only) €
<b>DENMARK</b>					
With Slesvig, Thule, Dan. West India	1851 - 1959	35 ☺	128		<b>98.00</b>
	1960 - 1971	15	128-60		<b>42.00</b>
	1972 - 1990	43 ☺	128A		<b>120.40</b>
	1991 - 2006	49 ☺	128-91		<b>137.20</b>
	2007 - 2016	48 ☺	128-07		<b>134.40</b>
	● 2017 - 2024	20	128-17		<b>56.00</b>
13 vending machine stamps with 9 showing no values		1	128AS		<b>5.80</b>
Special pages Booklets	2011 - 2015	5	128S		<b>14.00</b>
<b>EGYPT</b>					
	1971 - 1981	40 ☺	153A-71		<b>112.00</b>
	1982 - 1991	45 ☺	153A-82		<b>126.00</b>
	1992 - 2002	47 ☺	153A-92		<b>131.60</b>
	2003 - 2008	27 ☺	153A-03		<b>75.60</b>
<b>ESTONIA</b>					
	1991 - 2009	49 ☺	175		<b>137.20</b>
	2010 - 2021	47 ☺	175-10		<b>131.60</b>
	● 2022 - 2024	12	175-22		<b>33.60</b>
<b>EUROPE SPECIAL TERRITORIES</b>					
<b>Europe CEPT</b>					
	1956 - 1971	39 ☺	290A		<b>109.20</b>
	1972 - 1980	49 ☺	290A-72		<b>137.20</b>
	1981 - 1984	37 ☺	290A-81		<b>103.60</b>
	1985 - 1989	51 ☺	290A-85		<b>142.80</b>
	1990 - 1992	36 ☺	290A-90		<b>100.80</b>
<b>Europe CEPT Joint Issues of EU Countries</b>					
	1993 - 1999	49 ☺	290A-93		<b>137.20</b>
	2000 - 2006	42 ☺	290A-00		<b>117.60</b>
	2007 - 2011	50 ☺	290A-07		<b>140.00</b>
	2012 - 2015	46 ☺	290A-12		<b>128.80</b>
	● 2016 - 2019	48 ☺	290A-16		<b>134.40</b>
	● 2020 - 2023	48 ☺	290A-20		<b>134.40</b>
<b>Europe CEPT Sympathy Issues of non-EU Countries</b>					
	1993 - 2000	43 ☺	290S-93		<b>120.40</b>
	2001 - 2010	49 ☺	290S-01		<b>137.20</b>
	2011 - 2019	50 ☺	290S-11		<b>140.00</b>
	● 2020 - 2024	38 ☺	290S-20		<b>106.40</b>
<b>Europe CEPT Issues of the former Yugoslavia</b>					
	● 1993 - 2024	45 ☺	290JS		<b>126.00</b>
<b>Other Europe Issues and NORDEN</b>					
	1990 - 1992	12	290M		<b>33.60</b>
	1993 - 2005	51 ☺	290M-93		<b>142.80</b>
	2006 - 2015	45 ☺	290M-06		<b>126.00</b>
	● 2016 - 2024	24	290M-16		<b>67.20</b>
<b>European Year of Nature Protection</b>					
	1995	6	280		<b>16.80</b>
<b>FALKLAND-ISLANDS AND DEPENDENCIES (SOUTH GEORGIA AND SOUTH SANDWICH ISLANDS)</b>					
	1953 - 1981	32 ☺	410		<b>89.60</b>
	1982 - 1991	41 ☺	410-82		<b>114.80</b>
	1992 - 2000	46 ☺	410-92		<b>128.80</b>
	2001 - 2009	48 ☺	410-01		<b>134.40</b>
	2010 - 2016	51 ☺	410-10		<b>142.80</b>
	● 2017 - 2024	48 ☺	410-17		<b>134.40</b>
<b>FAROE ISLANDS</b>					
	1975 - 2001	45 ☺	128F		<b>126.00</b>
	2002 - 2015	45 ☺	128F-02		<b>126.00</b>
	● 2016 - 2024	39 ☺	128F-16		<b>109.20</b>
Booklets	1983 - 2024	45 ☺	128FH		<b>126.00</b>
<b>FINLAND</b>					
	1856 - 1962	41 ☺	129		<b>114.80</b>
	1963 - 1981	30 ☺	129-63		<b>84.00</b>
	1982 - 1995	46 ☺	129-82		<b>128.80</b>
	1996 - 2007	45 ☺	129-96		<b>126.00</b>
	2008 - 2014	49 ☺	129-08		<b>137.20</b>
	2015 - 2022	54 ☺	129-15		<b>151.20</b>
	● 2023 - 2024	8	129-23		<b>22.40</b>
Booklets	1988 - 2013	46 ☺	129H-88		<b>128.80</b>
	2014 - 2015	9	129H-14		<b>25.20</b>

Country	in colour	Period	Number of Pages		Price (pages only) €	
<b>FRANCE</b>						
Complete Offer*	● 1849 - 2024	746 ☺	1300C		<b>1566.60</b>	
	1849 - 1940	47 ☺	130		<b>131.60</b>	
	1940 - 1944	17	131-40		<b>47.60</b>	
	1945 - 1959	48 ☺	131-45		<b>134.40</b>	
	1960 - 1971	43 ☺	132		<b>120.40</b>	
	1972 - 1976	24	132A		<b>67.20</b>	
	● 1977 - 1983	38 ☺	132-77		<b>106.40</b>	
	● 1984 - 1989	35 ☺	132-84		<b>98.00</b>	
	● 1990 - 1997	46 ☺	132-90		<b>128.80</b>	
	● 1998 - 2002	48 ☺	132-98		<b>134.40</b>	
	● 2003 - 2005	38 ☺	132-03		<b>106.40</b>	
	● 2006 - 2008	50 ☺	132-06		<b>140.00</b>	
	● 2009 - 2011	48 ☺	132-09		<b>134.40</b>	
	● 2012 - 2013	37 ☺	132-12		<b>103.60</b>	
	● 2014 - 2015	39 ☺	132-14		<b>109.20</b>	
	● 2016 - 2017	40 ☺	132-16		<b>112.00</b>	
	● 2018 - 2019	38 ☺	132-18		<b>106.40</b>	
	● 2020 - 2021	42 ☺	132-20		<b>117.60</b>	
	● 2022 - 2023	45 ☺	132-22		<b>126.00</b>	
	Special pages for adhesive stamps	● 2008	2	132-06SA		<b>5.60</b>
		● 2009 - 2011	6	132-09SA		<b>16.80</b>
		● 2012 - 2013	2	132-12SA		<b>5.60</b>
		● 2014 - 2015	2	132-14SA		<b>5.60</b>
		● 2016 - 2017	2	132-16SA		<b>5.60</b>
		● 2018 - 2019	2	132-18SA		<b>5.60</b>
● 2020 - 2021		2	132-20SA		<b>5.60</b>	
● 2022 - 2023		1	132-22SA-2023		<b>5.80</b>	
Council of Europe - Official stamps		1958 - 2024	7	132RE		<b>19.60</b>
UNESCO - Official stamps	1961 - 2024	7	132RU		<b>19.60</b>	
Souvenir blocks	● 2006 - 2008	15	132-06B		<b>42.00</b>	
	● 2009 - 2011	16	132-09B		<b>44.80</b>	
	● 2012 - 2013	12	132-12B		<b>33.60</b>	
	● 2014 - 2015	14	132-14B		<b>39.20</b>	
	● 2016 - 2017	16	132-16B		<b>44.80</b>	
	● 2018 - 2019	14	132-18B		<b>39.20</b>	
	● 2020 - 2021	13	132-20B		<b>36.40</b>	
	● 2022 - 2023	15	132-22B		<b>42.00</b>	
	Blocs	● 2014	2	132-14BS		<b>5.60</b>
		● 2016 - 2017	5	132-16BS		<b>14.00</b>
● 2018 - 2019		5	132-18BS		<b>14.00</b>	
● 2020 - 2021		5	132-20BS		<b>14.00</b>	
● 2022 - 2023		5	132-22BS		<b>14.00</b>	
Sheetlets	● 1999 - 2002	8	132-98K		<b>22.40</b>	
	● 2003 - 2005	8	132-03K		<b>22.40</b>	
	● 2006 - 2008	11	132-06K		<b>30.80</b>	
	● 2009 - 2011	8	132-09K		<b>22.40</b>	
	● 2012 - 2013	3	132-12K		<b>8.40</b>	
	● 2014 - 2015	5	132-14K		<b>14.00</b>	
	● 2016 - 2017	4	132-16K		<b>11.20</b>	
	● 2018 - 2019	6	132-18K		<b>16.80</b>	
	● 2020 - 2021	8	132-20K		<b>22.40</b>	
	● 2022 - 2023	6	132-22K		<b>16.80</b>	
Booklets	1952 - 2009	61 ☺	132H		<b>170.80</b>	
	2010 - 2024	20	132H-10		<b>56.00</b>	
Blocs (CNEP)	1966 - 2024	43 ☺	132CNEP		<b>120.40</b>	
Single Stamps "Marianne Gold star"	● 2012	3	132-12M		<b>8.40</b>	
<b>FRENCH ANTARCTIC TERRITORIES</b>						
	1955 - 1997	46 ☺	440		<b>128.80</b>	
	1998 - 2012	52 ☺	440-98		<b>145.60</b>	
	2013 - 2020	47 ☺	440-13		<b>131.60</b>	
	● 2021 - 2024	26 ☺	440-21		<b>72.80</b>	
<b>FRENCH POLYNESIA</b>						
	1958 - 1983	44 ☺	442		<b>123.20</b>	
	1984 - 1994	45 ☺	442-84		<b>126.00</b>	
	1995 - 2009	50 ☺	442-95		<b>140.00</b>	
	2010 - 2021	49 ☺	442-10		<b>137.20</b>	
	● 2022 - 2024	12	442-22		<b>33.60</b>	
<b>GEORGIA</b>						
	1993 - 2002	44 ☺	256		<b>123.20</b>	

\* Partly in black/white. ☺ = Take advantage of our complete offers see page 113.

Country	in colour	Period	Number of Pages		Price (pages only) €
<b>GERMANY</b>					
German States without Bavaria and Wuerttemberg		1850 - 1879	34 ☺	107	95.20
Memel		1920 - 1939	14	108	39.20
Danzig		1920 - 1939	32 ☺	109	89.60
Bavaria		1849 - 1920	20	110	56.00
Wuerttemberg		1851 - 1923	11	111	30.80
<b>Germany</b>		1872 - 1923	26 ☺	112	72.80
		1923 - 1933	12	115	33.60
		1933 - 1945	43 ☺	116	120.40
Joint prints		1933 - 1941	40 ☺	116Z	112.00
Occupied Territories: Bohemia and Moravia		1939 - 1945	10	117A	28.00
Occupied Territories: Alsace, Lorraine, Luxembourg		1940 - 1941	4	117B	11.20
Occupied Territories: German East Post, Generalgouvernement, Estonia, Lithuania, Latvia, Eastland, Ukraine		1939 - 1944	14	117C	39.20
Occupied Territories: Channel Islands		1940 - 1943	3	117D	8.40
Occupied Territories: Albania, Kotor, Laibach, Macedonia, Montenegro, Zante, Zara		1943 - 1945	11	117E	30.80
Occupied Territories: Serbia		1941 - 1943	11	117F	30.80
<b>German Colonies and Offices abroad</b>		1897 - 1919	22	113	61.60
<b>Plebiscite Issues</b>		1920 - 1922	12	114A	33.60
<b>German Occupation Issues WW 1914-1918 and Belgian Occupied Territory 1919-1921</b>		1914 - 1921	10	114B	28.00
<b>Germany 1945-1949</b>		1946 - 1948	7	118A	19.60
Joint Issues for the American, British and Soviet Occupied Territory		1945 - 1949	12	118B	33.60
American and British Occupied Territories		1945 - 1949	18	118C	50.40
French occupied Territories		1945 - 1949	22	118D	61.60
Sovjet occupied territories		1948 - 1955	1	118XV-I	5.80
Obligatory Tax Stamps		1945 - 1946	9	118S	25.20
AM Post Special		1945 - 1946	45 ☺	119	126.00
<b>Germany / Federal Republic</b>		1949 - 2024	444 ☺	120B	932.40
Complete Offer*		1949 - 1959	17	120B-49	47.60
		1960 - 1969	30 ☺	120B-60	84.00
		1970 - 1979	48 ☺	120B-70	134.40
		1980 - 1989	44 ☺	120B-80	123.20
		1990 - 1994	41 ☺	120B-90	114.80
		1995 - 1999	44 ☺	120B-95	123.20
		2000 - 2004	46 ☺	120B-00	128.80
		2005 - 2009	41 ☺	120B-05	114.80
		2010 - 2014	38 ☺	120B-10	106.40
		2015 - 2019	44 ☺	120B-15	123.20
		2020 - 2023	41 ☺	120B-20	114.80
<b>Vending machine stamps</b>					
24 Vending Machine Stamps without values: emblem of the German Post Office			1	120BAS1	5.80
24 Vending Machine Stamps: Castle Sanssouci, Potsdam			1	120BAS2	5.80
24 Vending Machine Stamps without value: Postal emblem	●		1	120BAS3	5.80
24 Vending Machine Stamps without value: Postal emblem (€)	●		1	120BAS4	5.80
24 Vending Machine Stamps without values: mailboxes	●		1	120BAS5	5.80
24 Vending Machine Stamps without values: Brandenburger Gate, Berlin	●		1	120BAS6	5.80
24 Vending Machine Stamps without values: Post Tower, Bonn	●		1	120BAS7	5.80
24 Vending Machine Stamps without values: write letters	●		1	120BAS8	5.80
24 Vending Machine Stamps without values: receive letters	●		1	120BAS9	5.80

Country	in colour	Period	Number of Pages		Price (pages only) €
<b>Commemorative pages</b>					
		1989 - 2004	51 ☺	120B-EB	142.80
		2005 - 2012	51 ☺	120B-EB-05	142.80
		2013 - 2018	48 ☺	120B-EB-13	134.40
	●	2019 - 2024	45 ☺	120B-EB-19	126.00
<b>Stationery</b>					
Letter stationery		1998 - 2008	55 ☺	120B-BG	154.00
		2009 - 2015	56 ☺	120B-BG-09	156.80
	●	2016 - 2023	49 ☺	120B-BG-16	137.20
Philatelic Letter Stationery		1998 - 2016	49 ☺	120B-PG	137.20
	●	2017 - 2024	15	120B-PG-17	42.00
Postcards		1997 - 2016	47 ☺	120B-PK	131.60
	●	2017 - 2022	5	120B-PK-17	14.00
Special Postcards with philatelic exhibitions		1949 - 2011	50 ☺	120B-SK	140.00
<b>Definitive stamps</b>					
		1951 - 2024	29 ☺	120B-D	81.20
<b>Plate errors and other specialities</b>					
		1987 - 1989	25 ☺	120BF	70.00
		1990 - 1991	45 ☺	120BF-90	126.00
		1992 - 1993	53 ☺	120BF-92	148.40
		1994 - 1995	54 ☺	120BF-94	151.20
		1996 - 1997	35 ☺	120BF-96	98.00
<b>Self-adhesive panes</b>					
		2008 - 2015	48 ☺	120B-FS	134.40
	●	2016 - 2020	46 ☺	120B-FS-16	128.80
	●	2021 - 2024	36 ☺	120B-FS-21	100.80
<b>Booklets</b>					
		1951 - 2013	48 ☺	120B-H	134.40
		2014 - 2024	27 ☺	120B-H-14	75.60
<b>Booklets for the German Sports Aid</b>					
		1979 - 2011	50 ☺	120B-SH	140.00
		2012 - 2023	20	120B-SH-12	56.00
<b>Combinations</b>					
		1951 - 1994	45 ☺	120BZ	126.00
		1996 - 2007	16	120BZ-96	44.80
		2008 - 2024	16	120BZ-08	44.80
<b>Pairs from sheets</b>					
		1951 - 2023	21	120B-P	58.80
<b>Sheets of 10 stamps</b>					
		1979 - 1988	46 ☺	120BK	128.80
		1989 - 1991	59 ☺	120BK-89	165.20
		1992 - 1994	69 ☺	120BK-92	193.20
		1994 - 1995	54 ☺	120BK-94	151.20
		1996	42 ☺	120BK-96	117.60
		1997	37 ☺	120BK-97	103.60
		1998	38 ☺	120BK-98	106.40
		1999	34 ☺	120BK-99	95.20
		2000	52 ☺	120BK-00	145.60
		2001	48 ☺	120BK-01	134.40
		2002	49 ☺	120BK-02	137.20
		2003	46 ☺	120BK-03	128.80
		2004	43 ☺	120BK-04	120.40
		2005	46 ☺	120BK-05	128.80
		2006	50 ☺	120BK-06	140.00
		2007	39 ☺	120BK-07	109.20
		2008	43 ☺	120BK-08	120.40
		2009	37 ☺	120BK-09	103.60
		2010	44 ☺	120BK-10	123.20
		2011	45 ☺	120BK-11	126.00
		2012	46 ☺	120BK-12	128.80
		2013	44 ☺	120BK-13	123.20
		2014	42 ☺	120BK-14	117.60
		2015	42 ☺	120BK-15	117.60
		2016	42 ☺	120BK-16	117.60
	●	2017	46 ☺	120BK-17	128.80
	●	2018	45 ☺	120BK-18	126.00
	●	2019	50 ☺	120BK-19	140.00
	●	2020	43 ☺	120BK-20	120.40
	●	2021	43 ☺	120BK-21	120.40
	●	2022	59 ☺	120BK-22	165.20
	●	2023	55 ☺	120BK-23	154.00
	●	2024	55 ☺	120BK-24	154.00

Country	in colour	Period	Number of Pages		Price (pages only) €
<b>GERMANY</b>					
<b>West Germany / West Berlin</b>					
Special prints for the German Sports Aid		1976 - 1995	49 ☺	120S	137.20
Special prints for the German Sports Aid		1996 - 2023	50 ☺	120S-96	140.00
<b>Berlin</b>					
Complete Offer*	●	1948 - 1990	89 ☺	120C	186.90
		1948 - 1959	14	120C-48	39.20
		1960 - 1969	16	120C-60	44.80
	●	1970 - 1979	30 ☺	120C-70	84.00
	●	1980 - 1990	29 ☺	120C-80	81.20
15 Vending Machine Stamps without values			1	120CAS	5.80
Booklets		1949 - 1989	5	120C-H	14.00
Booklets for the "German Sports Aid"		1979 - 1990	4	120C-SH	11.20
Joint prints		1949 - 1989	20	120CZ	56.00
Sheet pairs		1949 - 1990	8	120C-P	22.40
Sheetlets		1979 - 1988	48 ☺	120CK	134.40
		1989 - 1990	24	120CK-89	67.20
<b>East Germany GDR</b>					
Complete Offer		1949 - 1990	323 ☺	121	678.30
		1949 - 1962	54 ☺	121A	151.20
		1963 - 1968	58 ☺	121B	162.40
		1969 - 1974	63 ☺	121C	176.40
		1975 - 1979	49 ☺	121D	137.20
		1980 - 1984	47 ☺	121-80	131.60
		1985 - 1990	52 ☺	121-85	145.60
Paper differences		1989 - 1990	1	121S	5.80
Booklet panes, official stamps and parcel post labels		1954 - 1988	19	121R	53.20
Booklets		1955 - 1988	4	121MH	11.20
Booklets (Booklet cover variations)		1971 - 1990	18	121HD	50.40
Joint prints		1955 - 1969	44 ☺	121Z	123.20
		1969 - 1979	57 ☺	121Z-69	159.60
		1980 - 1984	37 ☺	121Z-80	103.60
		1985 - 1990	60 ☺	121Z-85	168.00
Sheetlets		1977 - 1990	14	121K	39.20
Joint print sheetlets		1978 - 1990	16	121ZB	44.80
Special Postcards		1985 - 1990	7	121SK	19.60
Special envelopes		1984 - 1990	7	121SU	19.60
DDR/German Post (July until October 1990)	●	1990	2	121DP	5.60
DDR/German Post booklets		1990	1	121DP-H	5.80
DDR/German Post joint prints		1990	1	121DP-Z	5.80
DDR/German Post sheetlet pages		1990	1	121DP-R	5.80
<b>Saar I</b>					
		1920 - 1934	17	245	47.60
<b>Saar II</b>					
		1947 - 1959	21	246	58.80
<b>GIBRALTAR</b>					
		1886 - 1971	23	138	64.40
		1972 - 1984	29 ☺	138A	81.20
		1985 - 1999	48 ☺	138-85	134.40
		2000 - 2007	49 ☺	138-00	137.20
		2008 - 2014	49 ☺	138-08	137.20
		2015 - 2022	49 ☺	138-15	137.20
	●	2023 - 2024	15	138-23	42.00
<b>GREAT BRITAIN</b>					
		1840 - 1951	21	145	58.80
		1952 - 1969	35 ☺	145-52	98.00
		1970 - 1980	36 ☺	146	100.80
	●	1981 - 1989	40 ☺	146-81	112.00
	●	1990 - 1997	45 ☺	146-90	126.00
	●	1998 - 2004	47 ☺	146-98	131.60
	●	2005 - 2008	45 ☺	146-05	126.00
	●	2009 - 2012	56 ☺	146-09	156.80
	●	2013 - 2016	49 ☺	146-13	137.20
	●	2017 - 2019	46 ☺	146-17	128.80
	●	2020 - 2022	54 ☺	146-20	151.20
	●	2023 - 2024	43 ☺	146-23	120.40

\* Partly in black/white. ☺ = Take advantage of our complete offers see page 113.

Country	in colour	Period	Number of Pages		Price (pages only) €
<b>GERMANY</b>					
Booklets		1982 - 1998	44 ☺	146H-82	123.20
		1999 - 2010	50 ☺	146H-99	140.00
		2011 - 2020	53 ☺	146H-11	148.40
	●	2021 - 2024	22	146H-21	61.60
<b>GREECE</b>					
		1924 - 1949	27 ☺	140	75.60
		1950 - 1967	34 ☺	140-50	95.20
		1968 - 1980	43 ☺	141	120.40
		1981 - 1993	45 ☺	141-81	126.00
		1994 - 2004	49 ☺	141-94	137.20
		2005 - 2011	47 ☺	141-05	131.60
		2012 - 2016	51 ☺	141-12	142.80
	●	2017 - 2022	52 ☺	141-17	145.60
	●	2023 - 2024	10	141-23	28.00
Sheetlets		1980 - 2018	49 ☺	141K	137.20
	●	2019 - 2024	6	141K-19	16.80
Booklets		1984 - 2023	20	141H	56.00
Regional Stamps Athos		2008 - 2017	21	141R	58.80
<b>GREENLAND</b>					
		1905 - 1999	45 ☺	128G	126.00
		2000 - 2012	46 ☺	128G-00	128.80
		2013 - 2020	48 ☺	128G-13	134.40
	●	2021 - 2024	24	128G-21	67.20
Booklets		1989 - 2024	32 ☺	128GH	89.60
<b>GUERNSEY</b>					
		1969 - 1985	35 ☺	145G	98.00
		1986 - 1997	42 ☺	145G-86	117.60
		1998 - 2008	47 ☺	145G-98	131.60
		2009 - 2016	48 ☺	145G-09	134.40
	●	2017 - 2022	44 ☺	145G-17	123.20
	●	2023 - 2024	17	145G-23	47.60
<b>HONGKONG</b>					
		1946 - 1986	37 ☺	160-46	103.60
		1987 - 1997	62 ☺	160-87	173.60
After repatriation to the PRC		1997 - 2002	47 ☺	160-97	131.60
		2003 - 2006	53 ☺	160-03	148.40
		2007 - 2010	42 ☺	160-07	117.60
		2011 - 2013	45 ☺	160-11	126.00
		2014 - 2016	44 ☺	160-14	123.20
	●	2017 - 2019	47 ☺	160-17	131.60
	●	2020 - 2022	54 ☺	160-20	151.20
	●	2023 - 2024	39 ☺	160-23	109.20
<b>HUNGARY</b>					
		1871 - 1925	30 ☺	319	84.00
		1926 - 1944	34 ☺	319-26	95.20
		1945 - 1949	22	320	61.60
		1950 - 1957	40 ☺	320-50	112.00
		1958 - 1962	35 ☺	320-58	98.00
		1963 - 1967	58 ☺	321	162.40
		1968 - 1971	50 ☺	322	140.00
		1972 - 1975	55 ☺	322A	154.00
		1976 - 1980	48 ☺	322-76	134.40
		1981 - 1984	32 ☺	322-81	89.60
		1985 - 1989	47 ☺	322-85	131.60
		1990 - 1995	46 ☺	322-90	128.80
		1996 - 2002	43 ☺	322-96	120.40
		2003 - 2008	52 ☺	322-03	145.60
		2009 - 2013	43 ☺	322-09	120.40
		2014 - 2018	48 ☺	322-14	134.40
	●	2019 - 2023	51 ☺	322-19	142.80
<b>ICELAND</b>					
		1873 - 1943	19	155	53.20
		1944 - 1971	17	155-44	47.60
		1972 - 1995	40 ☺	155A	112.00
		1996 - 2010	49 ☺	155-96	137.20
		2011 - 2020	40 ☺	155-11	112.00

Country	in colour	Period	Number of Pages		Price (pages only) €
<b>INDIA</b>					
		1947 - 1973	43 ☺	158-47	120.40
		1974 - 1985	46 ☺	158-74	128.80
		1986 - 1996	46 ☺	158-86	128.80
		1997 - 2003	45 ☺	158-97	126.00
		2004 - 2007	32 ☺	158-04	89.60
<b>INDONESIA</b>					
		1984 - 1992	43 ☺	506	120.40
		1993 - 1998	46 ☺	506-93	128.80
		1999 - 2004	49 ☺	506-99	137.20
<b>IRELAND</b>					
		1922 - 1971	24	152	67.20
		1972 - 1984	30 ☺	152A	84.00
		1985 - 1995	47 ☺	152-85	131.60
		1996 - 2001	49 ☺	152-96	137.20
		2002 - 2007	47 ☺	152-02	131.60
		2008 - 2016	53 ☺	152-08	148.40
	●	2017 - 2024	50 ☺	152-17	140.00
<b>ISLE OF MAN</b>					
		1973 - 1985	33 ☺	145M	92.40
		1986 - 1996	46 ☺	145M-86	128.80
		1997 - 2005	49 ☺	145M-97	137.20
		2006 - 2012	53 ☺	145M-06	148.40
		2013 - 2016	44 ☺	145M-13	123.20
	●	2017 - 2021	49 ☺	145M-17	137.20
	●	2022 - 2024	39 ☺	145M-22	109.20
<b>ISRAEL</b>					
without tabs		1972 - 1984	35 ☺	156A	98.00
		1985 - 2002	48 ☺	156-85	134.40
		2003 - 2005	9	156-03	25.20
with tabs		1948 - 1959	23	157-48	64.40
		1960 - 1969	29 ☺	157-60	81.20
		1970 - 1979	47 ☺	157A	131.60
		1980 - 1989	44 ☺	157A-80	123.20
		1990 - 1999	45 ☺	157-90	126.00
		2000 - 2008	51 ☺	157-00	142.80
		2009 - 2013	47 ☺	157-09	131.60
		2014 - 2021	48 ☺	157-14	134.40
	●	2022 - 2024	15	157-22	42.00
Sheetlets		1963 - 2003	46 ☺	157K	128.80
		2004 - 2010	47 ☺	157K-04	131.60
		2011 - 2014	44 ☺	157K-11	123.20
		2015 - 2018	45 ☺	157K-15	126.00
	●	2019 - 2023	56 ☺	157K-19	156.80
Vending machine stamps		1990 - 1998	32 ☺	157AS	89.60
Definitive stamps, paper and phosphor variations		1965 - 1998	15	157PH	42.00
Special pages: supplement to the page No. 1-3 out of album 157-48		1948 - 1949	5	157-48S	14.00
<b>ITALY</b>					
		1862 - 1945	57 ☺	148	159.60
		1943 - 1944	7	149	19.60
		1945 - 1959	32 ☺	150-45	89.60
		1960 - 1969	17	150-60	47.60
		1970 - 1980	40 ☺	151	112.00
		1981 - 1990	47 ☺	151-81	131.60
		1991 - 1998	42 ☺	151-91	117.60
		1999 - 2005	45 ☺	151-99	126.00
		2006 - 2011	51 ☺	151-06	142.80
		2012 - 2015	45 ☺	151-12	126.00
	●	2016 - 2020	55 ☺	151-16	154.00
	●	2021 - 2023	48 ☺	151-21	134.40
Booklets		1989 - 2004	4	151H	11.20

Country	in colour	Period	Number of Pages		Price (pages only) €
<b>JAPAN</b>					
		1953 - 1960	22	162	61.60
		1961 - 1970	37 ☺	162-61	103.60
		1971 - 1980	39 ☺	163	109.20
		1981 - 1988	39 ☺	163-81	109.20
		1989 - 1991	45 ☺	163-89	126.00
		1992 - 1997	46 ☺	163-92	128.80
		1998 - 2000	50 ☺	163-98	140.00
		2001 - 2003	41 ☺	163-01	114.80
		2004 - 2006	51 ☺	163-04	142.80
		2007 - 2008	54 ☺	163-07	151.20
		2009	36 ☺	163-09	100.80
		2010	37 ☺	163-10	103.60
<b>JERSEY</b>					
		1969 - 1985	39 ☺	145J	109.20
		1986 - 1997	43 ☺	145J-86	120.40
		1998 - 2005	46 ☺	145J-98	128.80
		2006 - 2011	51 ☺	145J-06	142.80
		2012 - 2015	50 ☺	145J-12	140.00
	●	2016 - 2018	45 ☺	145J-16	126.00
	●	2019 - 2021	43 ☺	145J-19	120.40
	●	2022 - 2024	44 ☺	145J-22	123.20
<b>KIRGHIZIA</b>					
		1992 - 2002	41 ☺	257	114.80
<b>KOSOVO</b>					
UNMIK		2000 - 2008	12	171	33.60
Republic		2008 - 2019	47 ☺	171-08	131.60
	●	2020 - 2024	26	171-20	72.80
<b>LATVIA</b>					
		1991 - 2009	50 ☺	176	140.00
		2010 - 2022	50 ☺	176-10	140.00
	●	2023 - 2024	8	176-23	22.40
<b>LIECHTENSTEIN</b>					
		1912 - 1959	36 ☺	178	100.80
		1960 - 1971	19	178-60	53.20
		1972 - 1984	31 ☺	178A	86.80
		1985 - 2002	45 ☺	178-85	126.00
		2003 - 2014	42 ☺	178-03	117.60
		2015 - 2022	43 ☺	178-15	120.40
	●	2023 - 2024	11	178-23	30.80
Vending machine stamps		1995 - 2003	2	178AS	5.60
Sheetlets		1979 - 1980	41 ☺	179	114.80
		1981 - 1982	49 ☺	179-81	137.20
		1983 - 1984	50 ☺	179-83	140.00
		1985 - 1986	47 ☺	179-85	131.60
		1987 - 1988	41 ☺	179-87	114.80
		1989 - 1990	51 ☺	179-89	142.80
		1991 - 1992	41 ☺	179-91	114.80
		1993 - 1994	45 ☺	179-93	126.00
		1995 - 1996	39 ☺	179-95	109.20
		1997 - 1998	39 ☺	179-97	109.20
		1999 - 2000	58 ☺	179-99	162.40
		2001 - 2002	55 ☺	179-01	154.00
		2003 - 2004	53 ☺	179-03	148.40
		2005	30 ☺	179-05	84.00
<b>LITHUANIA</b>					
		1990 - 2005	47 ☺	177	131.60
		2006 - 2019	47 ☺	177-06	131.60
	●	2020 - 2024	15	177-20	42.00

Country	in colour	Period	Number of Pages		Price (pages only) €	
<b>LUXEMBOURG</b>						
		1852 - 1944	37 ☺	180	103.60	
		1945 - 1971	38 ☺	181	106.40	
		1972 - 1984	29 ☺	181A	81.20	
		1985 - 2003	46 ☺	181-85	128.80	
		2004 - 2015	45 ☺	181-04	126.00	
	●	2016 - 2024	41 ☺	181-16	114.80	
		24 vending machine stamps without value	1	181AS	5.80	
		Booklets	1986 - 2024	9	181H	25.20
<b>MACAO</b>						
		1884 - 1986	51 ☺	161	142.80	
		1987 - 1995	44 ☺	161-87	123.20	
		1996 - 1999	35 ☺	161-96	98.00	
After repatriation to the PRC		1999 - 2004	49 ☺	161-99	137.20	
		2005 - 2009	51 ☺	161-05	142.80	
		2010 - 2014	54 ☺	161-10	151.20	
		2015 - 2018	50 ☺	161-15	140.00	
	●	2019 - 2021	47 ☺	161-19	131.60	
	●	2022 - 2024	38 ☺	161-22	106.40	
Sheetlets		1985 - 1999	50 ☺	161K	140.00	
Booklets		1984 - 1995	3	161H	8.40	
After repatriation to the PRC sheetlets		1999 - 2004	36 ☺	161K-99	100.80	
		2005	9	161K-05	25.20	
After repatriation to the PRC special blocks		1998 - 1999	12	161SB	33.60	
<b>MACEDONIA</b>						
		1992 - 2008	51 ☺	174	142.80	
		2009 - 2015	26 ☺	174-09	72.80	
Postal tax stamps		1991 - 2008	22	174ZA	61.60	
<b>MADAGASCAR</b>						
		1958 - 1975	34 ☺	197	95.20	
		1976 - 1987	44 ☺	197-76	123.20	
		1988 - 1992	44 ☺	197-88	123.20	
		1993 - 1994	40 ☺	197-93	112.00	
<b>MADEIRA</b>						
Postal independence		1980 - 2007	50 ☺	224	140.00	
		2008 - 2024	38 ☺	224-08	106.40	
Sheetlets		1991 - 2024	23	224K	64.40	
Booklets		1981 - 2015	16	224H	44.80	
<b>MALTA</b>						
		1860 - 1971	38 ☺	184	106.40	
		1972 - 1984	30 ☺	184A	84.00	
		1985 - 1999	46 ☺	184-85	128.80	
		2000 - 2009	52 ☺	184-00	145.60	
		2010 - 2017	48 ☺	184-10	134.40	
	●	2018 - 2024	38 ☺	184-18	106.40	
<b>MALTESE ORDER, SOVEREIGN</b>						
		1966 - 1982	42 ☺	183	117.60	
		1983 - 1992	45 ☺	183-83	126.00	
		1993 - 2001	48 ☺	183-93	134.40	
		2002 - 2009	52 ☺	183-02	145.60	
		2010 - 2014	45 ☺	183-10	126.00	
		2015 - 2019	58 ☺	183-15	162.40	
	●	2020 - 2024	51 ☺	183-20	142.80	
<b>MARSHALL ISLANDS</b>						
		1984 - 1992	46 ☺	515	128.80	
		1993 - 1997	46 ☺	515-93	128.80	
		1998 - 2001	44 ☺	515-98	123.20	
		2002 - 2008	55 ☺	515-02	154.00	
		2009 - 2012	51 ☺	515-09	142.80	
		2013 - 2016	51 ☺	515-13	142.80	
	●	2017 - 2018	42 ☺	515-17	117.60	
	●	2019 - 2020	38 ☺	515-19	106.40	
	●	2021	36 ☺	515-21-2021	100.80	
<b>MAYOTTE, FRENCH PROTECTORATE</b>						
		1892 - 2011	31 ☺	130M	86.80	

Country	in colour	Period	Number of Pages		Price (pages only) €
<b>MEXICO</b>					
		1982 - 1991	46 ☺	540	128.80
		1992 - 1998	43 ☺	540-92	120.40
		1999 - 2004	36 ☺	540-99	100.80
<b>MICRONESIA</b>					
		1984 - 1995	47 ☺	513	131.60
		1996 - 1998	34 ☺	513-96	95.20
		1999 - 2000	40 ☺	513-99	112.00
		2001 - 2002	46 ☺	513-01	128.80
		2003 - 2005	54 ☺	513-03	151.20
		2006 - 2008	31 ☺	513-06	86.80
<b>MOLDOVA</b>					
		1991 - 2002	46 ☺	244	128.80
		2003 - 2009	28 ☺	244-03	78.40
<b>MONACO</b>					
		1885 - 1945	21	185	58.80
		1946 - 1959	37 ☺	185-46	103.60
		1960 - 1971	39 ☺	186	109.20
		1972 - 1979	47 ☺	186A	131.60
		1980 - 1985	43 ☺	186-80	120.40
		1986 - 1991	42 ☺	186-86	117.60
		1992 - 1998	46 ☺	186-92	128.80
		1999 - 2008	47 ☺	186-99	131.60
		2009 - 2016	47 ☺	186-09	131.60
	●	2017 - 2023	46 ☺	186-17	128.80
Booklets		1989 - 2000	5	186H	14.00
<b>MONTENEGRO</b>					
		2005 - 2023	50 ☺	170	140.00
<b>NAMIBIA</b>					
		1990 - 2000	47 ☺	510-90	131.60
		2001 - 2014	49 ☺	510-01	137.20
		2015 - 2024	24	510-15	67.20
Special pages for blocks		1997	6	510S-90	16.80
<b>NAURU</b>					
		1916 - 1984	32 ☺	472	89.60
		1985 - 2007	51 ☺	472-85	142.80
		2008	2	472-08	5.60
<b>NEPAL</b>					
with official stamps 1859-1983		1881 - 1972	24	187	67.20
		1973 - 2001	48 ☺	188	134.40
		2002 - 2016	47 ☺	188-02	131.60
	●	2017 - 2024	20	188-17	56.00
<b>NETHERLANDS</b>					
		1852 - 1944	36 ☺	190	100.80
		1945 - 1966	33 ☺	190-45	92.40
		1967 - 1971	16	191	44.80
		1972 - 1979	26 ☺	191A	72.80
	●	1980 - 1989	34 ☺	191-80	95.20
	●	1990 - 1998	46 ☺	191-90	128.80
	●	1999 - 2004	47 ☺	191-99	131.60
	●	2005 - 2009	48 ☺	191-05	134.40
	●	2010 - 2013	54 ☺	191-10	151.20
	●	2014 - 2017	52 ☺	191-14	145.60
	●	2018 - 2021	46 ☺	191-18	128.80
	●	2022 - 2024	33 ☺	191-22	92.40
14 vending machine stamps without value			1	191AS	5.80
Sheetlets		1988 - 2000	48 ☺	191K	134.40
		2001 - 2006	48 ☺	191K-01	134.40
		2007 - 2012	58 ☺	191K-07	162.40
		2013 - 2018	48 ☺	191K-13	134.40
	●	2019 - 2024	52 ☺	191K-19	145.60
Booklets		1964 - 1984	18	190H	50.40
		1985 - 2013	50 ☺	191H	140.00
		2014 - 2024	33 ☺	191H-14	92.40
Combinations		1940 - 1984	26 ☺	190Z	72.80
		1985 - 2001	35 ☺	191Z	98.00

Country	in colour	Period	Number of Pages		Price (pages only) €
<b>NETHERLANDS ANTILLES</b>					
		1949 - 1971	19	430	53.20
		1972 - 1985	42 ☺	430A	117.60
		1986 - 1999	46 ☺	430-86	128.80
		2000 - 2008	52 ☺	430-00	145.60
		2009 - 2010	15	430-09	42.00
<b>NETHERLANDS INDIES</b>					
		1864 - 1948	34 ☺	428	95.20
<b>NETHERLANDS NEW GUINEA WEST NEW GUINEA "UNTEA"</b>					
		1950 - 1962	6	432	16.80
<b>NEW CALEDONIA</b>					
		1953 - 1983	40 ☺	446	112.00
		1984 - 1996	44 ☺	446-84	123.20
		1997 - 2009	50 ☺	446-97	140.00
		2010 - 2024	43 ☺	446-10	120.40
<b>NEW ZEALAND</b>					
		1855 - 1952	30 ☺	494	84.00
		1953 - 1966	18	495-53	50.40
		1967 - 1980	42 ☺	495-67	117.60
		1981 - 1989	43 ☺	495-81	120.40
		1990 - 1994	43 ☺	495-90	120.40
		1995 - 1998	43 ☺	495-95	120.40
		1999 - 2002	48 ☺	495-99	134.40
		2003 - 2006	45 ☺	495-03	126.00
		2007 - 2010	48 ☺	495-07	134.40
		2011 - 2013	41 ☺	495-11	114.80
		2014 - 2016	45 ☺	495-14	126.00
		● 2017 - 2019	49 ☺	495-17	137.20
		● 2020 - 2022	46 ☺	495-20	128.80
		● 2023 - 2024	33 ☺	495-23	92.40
<b>NEWFOUNDLAND</b>					
		1857 - 1949	21	501	58.80
<b>NORFOLK-ISLAND</b>					
		1947 - 1984	32 ☺	473	89.60
		1985 - 1998	43 ☺	473-85	120.40
		1999 - 2012	51 ☺	473-99	142.80
		2013 - 2024	31 ☺	473-13	86.80
<b>NORTH KOREA</b>					
		1996 - 1998	53 ☺	193	148.40
		1999 - 2001	51 ☺	193-99	142.80
<b>NORWAY</b>					
		1855 - 1941	18	195	50.40
		1942 - 1971	29 ☺	195-42	81.20
		1972 - 1985	31 ☺	195A	86.80
		1986 - 1997	43 ☺	195-86	120.40
		1998 - 2010	48 ☺	195-98	134.40
		2011 - 2024	50 ☺	195-11	140.00
Booklets		1976 - 2010	48 ☺	195H	134.40
		2011 - 2015	12	195H-11	33.60
<b>OMAN</b>					
		1944 - 1990	43 ☺	182	120.40
		1991 - 2010	52 ☺	182-91	145.60
		2011 - 2019	48 ☺	182-11	134.40
		● 2020 - 2023	48 ☺	182-20	134.40
<b>PAKISTAN</b>					
		1947 - 1975	45 ☺	509	126.00
		1976 - 1990	46 ☺	509-76	128.80
		1991 - 2002	36 ☺	509-91	100.80
<b>PALAU</b>					
		1983 - 1992	48 ☺	514	134.40
		1993 - 1996	51 ☺	514-93	142.80
		1997 - 1998	37 ☺	514-97	103.60
		1999 - 2000	58 ☺	514-99	162.40
		2001 - 2003	54 ☺	514-01	151.20
		2004 - 2005	44 ☺	514-04	123.20
		2006 - 2008	37 ☺	514-06	103.60

Country	in colour	Period	Number of Pages		Price (pages only) €
<b>PALESTINE</b>					
		1994 - 2013	52 ☺	504	145.60
		2014 - 2023	40 ☺	504-14	112.00
<b>PAPUA NEW GUINEA</b>					
		1952 - 1984	40 ☺	476	112.00
		1985 - 1999	44 ☺	476-85	123.20
		2000 - 2007	51 ☺	476-00	142.80
		2008 - 2010	54 ☺	476-08	151.20
		2011 - 2013	54 ☺	476-11	151.20
		2014 - 2017	51 ☺	476-14	142.80
		● 2018 - 2021	32 ☺	476-18	89.60
<b>PITCAIRN ISLANDS</b>					
		1940 - 1985	30 ☺	477	84.00
		1986 - 2003	48 ☺	477-86	134.40
		2004 - 2017	48 ☺	477-04	134.40
		● 2018 - 2023	11	477-18	30.80
<b>POLAND</b>					
Kingdom/Republic		1860 - 1945	34 ☺	217-18	95.20
Republic		1944 - 1952	49 ☺	217-44	137.20
People's Republic		1952 - 1959	45 ☺	217-52	126.00
		1960 - 1964	52 ☺	217-60	145.60
		1965 - 1969	45 ☺	217-65	126.00
since 25 years People's Republic		1969 - 1971	27 ☺	218-69	75.60
		1972 - 1978	60 ☺	218B	168.00
		1979 - 1984	43 ☺	218-79	120.40
		1985 - 1989	38 ☺	218-85	106.40
		1990 - 1995	45 ☺	218-90	126.00
		1996 - 2001	41 ☺	218-96	114.80
		2002 - 2008	49 ☺	218-02	137.20
		2009 - 2014	49 ☺	218-09	137.20
		2015 - 2018	52 ☺	218-15	145.60
		● 2019 - 2022	54 ☺	218-19	151.20
		● 2023 - 2024	28 ☺	218-23	78.40
<b>PORTUGAL</b>					
		1853 - 1910	13	219	36.40
		1910 - 1933	31 ☺	219-10	86.80
		1934 - 1959	39 ☺	219-34	109.20
		1960 - 1977	49 ☺	220	137.20
		1978 - 1983	34 ☺	220-78	95.20
		1984 - 1989	37 ☺	220-84	103.60
		1990 - 1994	49 ☺	220-90	137.20
		1995 - 1998	46 ☺	220-95	128.80
		1999 - 2002	47 ☺	220-99	131.60
		2003 - 2005	52 ☺	220-03	145.60
		2006 - 2008	46 ☺	220-06	128.80
		2009 - 2011	47 ☺	220-09	131.60
		2012 - 2014	45 ☺	220-12	126.00
		2015 - 2017	55 ☺	220-15	154.00
		● 2018 - 2019	38 ☺	220-18	106.40
		● 2020 - 2022	42 ☺	220-20	117.60
		● 2023 - 2024	29 ☺	220-23	81.20
Vending machine stamps		1981 - 1996	7	220A-81	19.60
		1997 - 2006	48 ☺	220A-97	134.40
		2007 - 2012	48 ☺	220A-07	134.40
		2013 - 2020	50 ☺	220A-13	140.00
		● 2021 - 2024	24	220A-21	67.20
Sheetlets		1979 - 2007	48 ☺	220K	134.40
		2008 - 2024	33 ☺	220K-08	92.40
Booklets		1983 - 2019	8	220H	22.40
<b>RÉUNION</b>					
		1949 - 1974	15	503	42.00

Country	in colour	Period	Number of Pages		Price (pages only) €
<b>ROMANIA</b>					
		1948 - 1959	59 ☺	231-48	165.20
		1960 - 1964	50 ☺	231-60	140.00
		1965 - 1970	60 ☺	231-65	168.00
		1971 - 1975	57 ☺	231A	159.60
		1976 - 1979	48 ☺	231-76	134.40
		1980 - 1984	50 ☺	231-80	140.00
		1985 - 1987	43 ☺	231-85	120.40
		1988 - 1991	42 ☺	231-88	117.60
		1992 - 1994	41 ☺	231-92	114.80
		1995 - 1999	40 ☺	231-95	112.00
		2000 - 2004	49 ☺	231-00	137.20
		2005 - 2006	45 ☺	231-05	126.00
		2007	24	231-07	67.20
<b>ROSS DEPENDENCY</b>					
		1957 - 2024	35 ☺	496	98.00
<b>RUSSIA, REPUBLIC</b>					
		1858 - 1917	14	237	39.20
		1918 - 1923	9	238	25.20
		1923 - 1934	29 ☺	238-23	81.20
		1935 - 1944	45 ☺	238-35	126.00
		1945 - 1949	57 ☺	238-45	159.60
		1950 - 1956	52 ☺	238-50	145.60
		1957 - 1960	55 ☺	238-57	154.00
		1961 - 1963	47 ☺	238-61	131.60
		1964 - 1966	55 ☺	238-64	154.00
		1967 - 1969	47 ☺	238-67	131.60
		1970 - 1973	58 ☺	239	162.40
		1974 - 1976	42 ☺	240	117.60
		1977 - 1979	47 ☺	241	131.60
		1980 - 1982	39 ☺	241-80	109.20
		1983 - 1986	52 ☺	241-83	145.60
		1987 - 1989	44 ☺	241-87	123.20
		1990 - 1991	24	241-90	67.20
Republic (Russian Federation)		1992 - 1997	45 ☺	241-92	126.00
		1998 - 2002	46 ☺	241-98	128.80
		2003 - 2006	49 ☺	241-03	137.20
		2007 - 2010	44 ☺	241-07	123.20
		2011 - 2013	52 ☺	241-11	145.60
		2014 - 2015	39 ☺	241-14	109.20
		● 2016 - 2018	53 ☺	241-16	148.40
		● 2019 - 2020	44 ☺	241-19	123.20
		● 2021 - 2022	50 ☺	241-21	140.00
		● 2023	29 ☺	241-23-2023	81.20
		● 2024	31 ☺	241-24-2024	86.80
<b>SAN MARINO</b>					
		1945 - 1955	24	249	67.20
		1956 - 1967	35 ☺	249-56	98.00
		1968 - 1982	34 ☺	250	95.20
		1983 - 1996	46 ☺	250-83	128.80
		1997 - 2007	54 ☺	250-97	151.20
		2008 - 2016	51 ☺	250-08	142.80
		● 2017 - 2024	42 ☺	250-17	117.60
<b>SERB BOSNIA-HERZEGOVINA, REPUBLIC</b>					
		1992 - 2011	51 ☺	173SBH	142.80
		2012 - 2015	13	173SBH-12	36.40
<b>SERB KRAJINA, REPUBLIC</b>					
		1993 - 1997	6	168SK	16.80
<b>SERBIA</b>					
		2006 - 2015	49 ☺	196	137.20
		● 2016 - 2021	46 ☺	196-16	128.80
		● 2022 - 2024	34 ☺	196-22	95.20
<b>SINGAPORE</b>					
		1948 - 1986	59 ☺	498-48	165.20
		1987 - 1996	47 ☺	498	131.60
		1997 - 2002	49 ☺	498-97	137.20
		2003 - 2006	56 ☺	498-03	156.80

Country	in colour	Period	Number of Pages		Price (pages only) €
<b>SLOVAKIA</b>					
		1939 - 1945	14	308	39.20
<b>SLOVAKIAN REPUBLIC</b>					
		1993 - 2007	51 ☺	313	142.80
		2008 - 2018	49 ☺	313-08	137.20
		2019 - 2024	32 ☺	313-19	89.60
<b>SLOVENIA</b>					
		1991 - 2003	46 ☺	169	128.80
		2004 - 2011	51 ☺	169-04	142.80
		2012 - 2018	50 ☺	169-12	140.00
		● 2019 - 2024	42 ☺	169-19	117.60
Sheetlets		1992 - 2007	51 ☺	169K	142.80
		2008 - 2014	50 ☺	169K-08	140.00
		2015 - 2018	45 ☺	169K-15	126.00
		● 2019 - 2023	49 ☺	169K-19	137.20
<b>SOUTH AFRICA</b>					
		1910 - 1960	20	508	56.00
		1961 - 1984	40 ☺	508A	112.00
		1985 - 1996	48 ☺	508-85	134.40
		1997 - 2002	45 ☺	508-97	126.00
		2003 - 2009	44 ☺	508-03	123.20
		2010 - 2014	46 ☺	508-10	128.80
		2015 - 2021	32 ☺	508-15	89.60
<b>SOUTH KOREA</b>					
		1990 - 1995	34 ☺	192	95.20
<b>SOUTHWEST AFRICA</b>					
		1923 - 1960	17	510	47.60
		1961 - 1984	30 ☺	510A	84.00
		1985 - 1990	13	510-85	36.40
<b>SPAIN</b>					
		1850 - 1882	13	268	36.40
		1889 - 1939	49 ☺	268-89	137.20
		1936 - 1954	24	268-36	67.20
		1950 - 1959	14	269-50	39.20
		1960 - 1969	55 ☺	270	154.00
		1970 - 1975	32 ☺	271	89.60
		1976 - 1981	31 ☺	272	86.80
		1982 - 1984	14	272-82	39.20
		● 1985 - 1991	43 ☺	272-85	120.40
		● 1992 - 1997	44 ☺	272-92	123.20
		● 1998 - 2002	45 ☺	272-98	126.00
		● 2003 - 2007	48 ☺	272-03	134.40
		● 2008 - 2011	51 ☺	272-08	142.80
		● 2012 - 2014	43 ☺	272-12	120.40
		● 2015 - 2017	51 ☺	272-15	142.80
		● 2018 - 2019	38 ☺	272-18	106.40
		● 2020 - 2021	44 ☺	272-20	123.20
		● 2022 - 2023	44 ☺	272-22	123.20
Booklets		1986 - 1990	2	272H	5.60
Special page: block No. 139	●	2004	1	272-03226A	5.80
Special page: 150 years Spanish stamps		2000	4	272-98S	11.20
Special page: definitive stamps "King Juan Carlos I." on phosphorescent paper		1982 - 1987	1	272-S1	5.80
Special page: definitive stamps "King Juan Carlos I." on phosphorescent paper		1988 - 1990	1	272-S2	5.80
Special page: sheetlet foundation 25 years Prince of Asturias (MICHEL No. 4079)	●	2005	1	272-03234A	5.80
<b>ST. PIERRE AND MIQUELON</b>					
		1885 - 1951	26 ☺	448A	72.80
		1952 - 1976	16	448-52	44.80
		1985 - 2007	50 ☺	448	140.00
		2008 - 2021	50 ☺	448-08	140.00
		● 2022 - 2024	12	448-22	33.60

Country	in colour	Period	Number of Pages		Price (pages only) €
<b>SWEDEN</b>					
		1855 - 1945	34 ☺	252	<b>95.20</b>
		1946 - 1963	24	252-46	<b>67.20</b>
		1964 - 1971	31 ☺	253	<b>86.80</b>
		1972 - 1980	43 ☺	254	<b>120.40</b>
		1981 - 1990	43 ☺	254-81	<b>120.40</b>
		1991 - 2000	46 ☺	254-91	<b>128.80</b>
		2001 - 2010	47 ☺	254-01	<b>131.60</b>
		2011 - 2019	45 ☺	254-11	<b>126.00</b>
		● 2020 - 2024	26 ☺	254-20	<b>72.80</b>
Booklets		1964 - 1971	12	253P	<b>33.60</b>
		1972 - 1980	21	254P	<b>58.80</b>
		1981 - 1994	45 ☺	254P-81	<b>126.00</b>
		1995 - 2006	51 ☺	254P-95	<b>142.80</b>
		2007 - 2019	51 ☺	254P-07	<b>142.80</b>
		● 2020 - 2024	16	254P-20	<b>44.80</b>
<b>SWITZERLAND</b>					
Complete Offer*	●	1843 - 2024	353 ☺	260	<b>741.30</b>
without int. Organisations		1843 - 1937	40 ☺	259	<b>112.00</b>
		1938 - 1959	40 ☺	260-38	<b>112.00</b>
		1960 - 1967	22	260-60	<b>61.60</b>
		1968 - 1975	19	260A	<b>53.20</b>
		● 1976 - 1984	23	260-76	<b>64.40</b>
		● 1985 - 1998	45 ☺	260-85	<b>126.00</b>
		● 1999 - 2009	49 ☺	260-99	<b>137.20</b>
		● 2010 - 2016	46 ☺	260-10	<b>128.80</b>
		● 2017 - 2022	51 ☺	260-17	<b>142.80</b>
		● 2023 - 2024	18	260-23	<b>50.40</b>
Blocks of Four		1960 - 1970	51 ☺	261	<b>142.80</b>
		1971 - 1979	46 ☺	262	<b>128.80</b>
		1980 - 1987	41 ☺	262-80	<b>114.80</b>
		1988 - 1995	44 ☺	262-88	<b>123.20</b>
		1996 - 2003	48 ☺	262-96	<b>134.40</b>
		2004 - 2009	46 ☺	262-04	<b>128.80</b>
		2010 - 2014	44 ☺	262-10	<b>123.20</b>
		2015 - 2019	48 ☺	262-15	<b>134.40</b>
		● 2020 - 2023	42 ☺	262-20	<b>117.60</b>
Int. Organisations		1922 - 2008	28 ☺	263	<b>78.40</b>
Sheetlets		1981 - 2012	48 ☺	260K	<b>134.40</b>
		2013 - 2020	50 ☺	260K-13	<b>140.00</b>
		● 2021 - 2024	34 ☺	260K-21	<b>95.20</b>
Booklets-Definitives and "Pro Patria"		1979 - 2024	43 ☺	260H-79	<b>120.40</b>
Booklets "Pro Juventute"		1980 - 2024	16	261H-80	<b>44.80</b>
Special page sheetlet embroidery of St. Gallen	●	2000	1	260-99S	<b>5.80</b>
Combinations		1968 - 2012	54 ☺	260Z-68	<b>151.20</b>
		2013 - 2024	33 ☺	260Z-13	<b>92.40</b>
<b>SYRIA</b>					
		1971 - 1983	40 ☺	153D	<b>112.00</b>
		1984 - 1989	20	153D-84	<b>56.00</b>
<b>THAILAND</b>					
		1950 - 1969	19	189-50	<b>53.20</b>
		1970 - 1979	37 ☺	189-70	<b>103.60</b>
		1980 - 1987	45 ☺	189-80	<b>126.00</b>
		1988 - 1991	44 ☺	189-88	<b>123.20</b>
		1992 - 1994	42 ☺	189-92	<b>117.60</b>
		1995 - 1996	37 ☺	189-95	<b>103.60</b>
		1997 - 1999	52 ☺	189-97	<b>145.60</b>
		2000 - 2002	47 ☺	189-00	<b>131.60</b>
		2003 - 2005	43 ☺	189-03	<b>120.40</b>
		2006	15	189-06	<b>42.00</b>
<b>TRANSKEI</b>					
		1976 - 1994	35 ☺	516	<b>98.00</b>

Country	in colour	Period	Number of Pages		Price (pages only) €
<b>TURKEY</b>					
		1920 - 1943	53 ☺	315	<b>148.40</b>
		1944 - 1954	37 ☺	315-44	<b>103.60</b>
		1955 - 1959	33 ☺	315-55	<b>92.40</b>
		1960 - 1970	50 ☺	315-60	<b>140.00</b>
		1971 - 1980	34 ☺	316	<b>95.20</b>
		1981 - 1991	44 ☺	316-81	<b>123.20</b>
		1992 - 2003	47 ☺	316-92	<b>131.60</b>
		2004 - 2010	49 ☺	316-04	<b>137.20</b>
		2011 - 2015	55 ☺	316-11	<b>154.00</b>
<b>UKRAINE</b>					
		1992 - 2001	48 ☺	243	<b>134.40</b>
		2002 - 2008	52 ☺	243-02	<b>145.60</b>
		2009 - 2014	51 ☺	243-09	<b>142.80</b>
		2015 - 2019	47 ☺	243-15	<b>131.60</b>
		● 2020 - 2024	51 ☺	243-20	<b>142.80</b>
<b>UNITED ARAB EMIRATES</b>					
		1973 - 1992	43 ☺	154-73	<b>120.40</b>
		1993 - 2006	48 ☺	154-93	<b>134.40</b>
		2007 - 2012	51 ☺	154-07	<b>142.80</b>
		2013 - 2021	54 ☺	154-13	<b>151.20</b>
		● 2022 - 2024	29 ☺	154-22	<b>81.20</b>
<b>UNITED NATIONS GENEVA</b>					
		1969 - 1997	44 ☺	265	<b>123.20</b>
		1998 - 2012	51 ☺	265-98	<b>142.80</b>
		2013 - 2022	51 ☺	265-13	<b>142.80</b>
		● 2023 - 2024	9	265-23	<b>25.20</b>
Sheetlets and se-tenant sheetlets		1976 - 2007	50 ☺	265K	<b>140.00</b>
		2008 - 2021	47 ☺	265K-08	<b>131.60</b>
		● 2022 - 2024	21	265K-22	<b>58.80</b>
Booklets		1995 - 2024	27 ☺	265H	<b>75.60</b>
<b>UNITED NATIONS NEW YORK</b>					
		1951 - 1981	42 ☺	600	<b>117.60</b>
		1982 - 1999	49 ☺	600-82	<b>137.20</b>
		2000 - 2012	53 ☺	600-00	<b>148.40</b>
		2013 - 2018	48 ☺	600-13	<b>134.40</b>
		● 2019 - 2024	34 ☺	600-19	<b>95.20</b>
"Flag Series" (stamps and sheets)		1980 - 1989	50 ☺	601	<b>140.00</b>
		1997 - 2024	22	601-97	<b>61.60</b>
"Flag Series" sheetlets		1980 - 1999	46 ☺	600S	<b>128.80</b>
		2001 - 2024	12	600S-01	<b>33.60</b>
"Flag Series" combinations		1980 - 2024	34 ☺	601Z	<b>95.20</b>
Sheetlets (without "Flag Series") and se-tenant sheetlets		1976 - 2006	51 ☺	600K	<b>142.80</b>
		2007 - 2013	51 ☺	600K-07	<b>142.80</b>
		2014 - 2021	45 ☺	600K-14	<b>126.00</b>
		● 2022 - 2024	23	600K-22	<b>64.40</b>
Booklets		1995 - 2024	27 ☺	600H	<b>75.60</b>
<b>UNITED NATIONS VIENNA</b>					
		1979 - 2001	47 ☺	605	<b>131.60</b>
		2002 - 2013	47 ☺	605-02	<b>131.60</b>
		2014 - 2021	48 ☺	605-14	<b>134.40</b>
		● 2022 - 2024	13	605-22	<b>36.40</b>
Sheetlets and se-tenant sheetlets		1983 - 2007	48 ☺	605K	<b>134.40</b>
		2008 - 2018	50 ☺	605K-08	<b>140.00</b>
		● 2019 - 2024	30 ☺	605K-19	<b>84.00</b>
Booklets		1995 - 2024	27 ☺	605H	<b>75.60</b>

Country	in colour	Period	Number of Pages		Price (pages only) €
<b>USA</b>					
Reg. Issues, Commemoratives and Air mails	1847 - 1936	54 ☺	512		151.20
	1937 - 1968	54 ☺	512-37		151.20
	1969 - 1977	46 ☺	512-69		128.80
	1978 - 1983	37 ☺	512-78		103.60
	1984 - 1989	42 ☺	512-84		117.60
	1990 - 1994	58 ☺	512-90		162.40
	1995 - 1998	45 ☺	512-95		126.00
	1999 - 2002	45 ☺	512-99		126.00
	2003 - 2008	51 ☺	512-03		142.80
	2009 - 2014	47 ☺	512-09		131.60
	2015 - 2021	52 ☺	512-15		145.60
● 2022 - 2024	25 ☺	512-22		70.00	
Officials, Postage Dues and Booklets	1879 - 1992	48 ☺	512R		134.40
Officials, Booklets and Self-adhesive Booklet Panes	1993 - 2000	46 ☺	512R-93		128.80
Booklets and self-adhesive Panes	2001 - 2008	48 ☺	512R-01		134.40
	2009 - 2024	45 ☺	512R-09		126.00
<b>VANUATU</b>					
	1980 - 1993	48 ☺	478		134.40
	1994 - 2005	46 ☺	478-94		128.80
	2006 - 2008	15	478-06		42.00
<b>VATICAN</b>					
	1929 - 1958	26 ☺	172-29		72.80
	1958 - 1963	10	172-58		28.00
	1963 - 1978	30 ☺	172-63		84.00
	1979 - 1994	46 ☺	172-79		128.80
	1995 - 2004	42 ☺	172-95		117.60
	2005 - 2015	44 ☺	172-05		123.20
	2016 - 2024	47 ☺	172-16		131.60
Vending machine stamps	2000 - 2004	2	172AS		5.60
<b>WALLIS AND FUTUNA ISLANDS</b>					
	1955 - 1983	31 ☺	444		86.80
	1984 - 2000	44 ☺	444-84		123.20
	2001 - 2019	51 ☺	444-01		142.80
	● 2020 - 2024	9	444-20		25.20
<b>YUGOSLAVIA</b>					
	1918 - 1943	34 ☺	165		95.20
	1944 - 1959	45 ☺	165-44		126.00
	1960 - 1969	44 ☺	165-60		123.20
	1970 - 1980	51 ☺	166		142.80
	1981 - 1986	40 ☺	166-81		112.00
	1987 - 1991	46 ☺	166-87		128.80
	1992 - 2001	48 ☺	166-92		134.40
	2002 - 2006	25 ☺	166-02		70.00

## LINDNER DOUBLE-T ILLUSTRATED PAGES

Country	in colour	Period	Number of Pages		Price (pages only) €
<b>AUSTRIA</b>					
<b>Austria</b>					
Complete offer*	● 1945 - 2024	375 ☺	dT209S		1312.50
	1945 - 1967	53 ☺	dT207		212.00
	1968 - 1974	25 ☺	dT208		100.00
	● 1975 - 1984	34 ☺	dT209		136.00
	● 1985 - 1995	42 ☺	dT209-85		168.00
	● 1996 - 2006	53 ☺	dT209-96		212.00
	● 2007 - 2011	45 ☺	dT209-07		180.00
	● 2012 - 2016	47 ☺	dT209-12		188.00
	● 2017 - 2021	47 ☺	dT209-17		188.00
	● 2022 - 2024	29 ☺	dT209-22		116.00
	<b>Sheetlets</b>				
	1988 - 2008	51 ☺	dT209K		204.00
	2009 - 2014	48 ☺	dT209K-09		192.00
	2015 - 2021	51 ☺	dT209K-15		204.00
	2022 - 2024	25 ☺	dT209K-22		100.00
<b>GERMANY</b>					
<b>Germany / Federal Republic</b>					
Complete Offer*	● 1949 - 2024	444 ☺	dT120B		1554.00
	1949 - 1959	17	dT120B-49		68.00
	1960 - 1969	30 ☺	dT120B-60		120.00
	● 1970 - 1979	48 ☺	dT120B-70		192.00
	● 1980 - 1989	44 ☺	dT120B-80		176.00
	● 1990 - 1994	41 ☺	dT120B-90		164.00
	● 1995 - 1999	44 ☺	dT120B-95		176.00
	● 2000 - 2004	46 ☺	dT120B-00		184.00
	● 2005 - 2009	41 ☺	dT120B-05		164.00
	● 2010 - 2014	38 ☺	dT120B-10		152.00
	● 2015 - 2019	44 ☺	dT120B-15		176.00
	● 2020 - 2023	41 ☺	dT120B-20		164.00
	<b>Berlin</b>				
Complete Offer*	● 1948 - 1990	89 ☺	dT120C		311.50
	1948 - 1959	14	dT120C-48		56.00
	1960 - 1969	16	dT120C-60		64.00
	● 1970 - 1979	30 ☺	dT120C-70		120.00
	● 1980 - 1990	29 ☺	dT120C-80		116.00
<b>East Germany GDR</b>					
Complete Offer	1949 - 1990	323 ☺	dT121		1130.50
	1949 - 1962	54 ☺	dT121A		216.00
	1963 - 1968	58 ☺	dT121B		232.00
	1969 - 1974	63 ☺	dT121C		252.00
	1975 - 1979	49 ☺	dT121D		196.00
	1980 - 1984	47 ☺	dT121-80		188.00
	1985 - 1990	52 ☺	dT121-85		208.00
	DDR/German Post (July until October 1990)	● 1990	2	dT121DP	
<b>SWITZERLAND</b>					
without int. Organisations	1938 - 1959	40 ☺	dT260-38		160.00
	1960 - 1967	22	dT260-60		88.00
	1968 - 1975	19	dT260A		76.00
	● 1976 - 1984	23	dT260-76		92.00
	● 1985 - 1998	45 ☺	dT260-85		180.00
	● 1999 - 2009	49 ☺	dT260-99		196.00
	● 2010 - 2016	46 ☺	dT260-10		184.00
	● 2017 - 2022	51 ☺	dT260-17		204.00
	● 2023 - 2024	18	dT260-23		72.00

\* Partly in black/white. ☺ = Take advantage of our complete offers see page 113.

## A

ÅLAND ISLANDS			
2020	in color	129A-16-2020	€ 10.00
2021	in color	129A-16-2021	€ 13.80
2022	in color	129A-16-2022	€ 15.00
2023	in color	129A-16-2023	€ 15.00
2024	in color	129A-16-2024	€ 15.90
ALDERNEY			
2020		145GA-12-2020	€ 21.00
2021		145GA-12-2021	€ 18.40
2022		145GA-12-2022	€ 20.00
2023		145GA-12-2023	€ 20.00
2024	in color	145GA-24-2024	€ 22.90
ANDORRA			
French			
2020		124A-08-2020	€ 10.00
2021		124A-08-2021	€ 10.00
2022		124A-08-2022	€ 11.00
2023		124A-08-2023	€ 11.00
2024		124A-08-2024	€ 11.60
Spanish			
2020	in color	123-16-2020	€ 13.80
2021	in color	123-16-2021	€ 13.80
2022	in color	123-16-2022	€ 15.00
2023	in color	123-16-2023	€ 15.00
2024	in color	123-16-2024	€ 15.90
ARUBA			
2020		431-11-2020	€ 10.00
2021		431-11-2021	€ 5.00
2022		431-11-2022	€ 11.00
2023		431-11-2023	€ 11.00
2024		431-11-2024	€ 5.80
AUSTRALIA			
2020	in color	470-19-2020	€ 99.90
2021	in color	470-21-2021	€ 86.60
2022	in color	470-21-2022	€ 89.70
2023	in color	470-23-2023	€ 87.50
2024	in color	470-23-2024	€ 113.40
AUSTRALIAN ANTARCTIC TERRITORY			
2020		471-2020	€ 10.00
2021		471-2021	€ 10.00
2022		471-2022	€ 11.00
2023		471-2023	€ 11.00
2024		471-2024	€ 11.60
AUSTRIA			
2020	in color	209-17-2020	€ 39.00
2021	in color	209-17-2021	€ 37.00
2022	in color	209-22-2022	€ 40.70
2023	in color	209-22-2023	€ 36.00
2024	in color	209-22-2024	€ 42.00
Booklets			
2020		209H-11-2020	€ 13.80
2022		209H-11-2022	€ 11.00
2023		209H-11-2023	€ 5.50
Dispenser			
2020	in color	209D-17-2020	€ 10.00
2021	in color	209D-17-2021	€ 10.00
2022	in color	209D-17-2022	€ 11.00
2023	in color	209D-17-2023	€ 11.00
2024	in color	209D-17-2024	€ 11.60
Personalized issues of the OSD			
Personalized sheets of the OSD			
2020	in color	209PM-B-20-2020	€ 88.80
2021	in color	209PM-B-20-2021	€ 88.80
2022	in color	209PM-B-22-2022	€ 93.60
2023	in color	209PM-B-22-2023	€ 85.80
2024	in color	209PM-B-24-2024	€ 105.00
Personalized single stamps of the OSD			
2020		209PM-E-2020	€ 5.00
2021		209PM-E-2021	€ 5.00
2022		209PM-E-2022	€ 5.50
2023		209PM-E-2023	€ 5.50
2024		209PM-E-2024	€ 5.80
Self-adhesive panes			
2020		209FS-2020	€ 18.40
2022		209FS-2022	€ 20.00
2023		209FS-2023	€ 5.50
Sheetlets			
2020		209K-15-2020	€ 30.40
2021		209K-15-2021	€ 30.40
2022	in color	209K-22-2022	€ 33.70
2023	in color	209K-22-2023	€ 32.00
2024	in color	209K-22-2024	€ 38.70
Vending machine stamps			
2020	in color	209AS-18-2020	€ 25.20
2021	in color	209AS-18-2021	€ 21.00
2022	in color	209AS-18-2022	€ 23.00
2023	in color	209AS-18-2023	€ 23.00
2024	in color	209AS-18-2024	€ 24.50

## AZORES

2020		222-08-2020	€ 10.00
2021		222-08-2021	€ 10.00
2022		222-08-2022	€ 11.00
2023		222-08-2023	€ 11.00
2024		222-08-2024	€ 11.60
Sheetlets			
2020		222K-2020	€ 5.00
2021		222K-2021	€ 5.00
2022		222K-2022	€ 5.50
2023		222K-2023	€ 5.50
2024		222K-2024	€ 5.80

## B

BELARUS			
2020	in color	242-17-2020	€ 51.80
2021	in color	242-21-2021	€ 38.50
2022	in color	242-21-2022	€ 39.00
2023	in color	242-21-2023	€ 70.20
2024	in color	242-21-2024	€ 67.20

## BELGIUM

2020	in color	127-18-2020	€ 48.10
2021	in color	127-21-2021	€ 49.60
2022	in color	127-21-2022	€ 54.60
2023	in color	127-21-2023	€ 46.80
2024	in color	127-21-2024	€ 54.60
Booklets			
2020	in color	126R-16-2020	€ 5.00
2021	in color	126R-16-2021	€ 5.00
2022	in color	126R-16-2022	€ 5.50
2023	in color	126R-16-2023	€ 5.50
2024	in color	126R-16-2024	€ 5.80

## BRITISH ANTARCTIC TERRITORIES

2020		405-09-2020	€ 5.00
2021		405-09-2021	€ 13.80
2022		405-09-2022	€ 11.00
2023		405-09-2023	€ 23.00
2024		405-09-2024	€ 15.90

## C

CANADA			
2020	in color	500-19-2020	€ 26.60
2021	in color	500-19-2021	€ 34.20
2022	in color	500-19-2022	€ 42.90
2023	in color	500-19-2023	€ 28.00
2024	in color	500-19-2024	€ 34.40

## CHINA, PEOPLE'S REPUBLIC

2020	in color	159-18-2020	€ 51.80
2021	in color	159-21-2021	€ 60.70
2022	in color	159-21-2022	€ 54.60
2023	in color	159-21-2023	€ 58.50
2024	in color	159-24-2024	€ 56.30

## CHRISTMAS ISLANDS

2020	in color	474-17-2020	€ 18.40
2021	in color	474-17-2021	€ 18.40
2022	in color	474-17-2022	€ 15.00
2023	in color	474-17-2023	€ 20.00
2024	in color	474-17-2024	€ 21.20

## COCOS (KEELING) ISLANDS

2020		475-13-2020	€ 10.00
2021		475-13-2021	€ 5.00
2022		475-13-2022	€ 11.00
2023		475-13-2023	€ 11.00
2024		475-13-2024	€ 11.60

## CROATIA, REPUBLIC

2020	in color	168-20-2020	€ 28.10
2021	in color	168-20-2021	€ 26.60
2022	in color	168-20-2022	€ 27.60
2023	in color	168-20-2023	€ 28.00
2024	in color	168-20-2024	€ 29.40
Sheetlets			
2020	in color	168K-20-2020	€ 79.20
2021	in color	168K-20-2021	€ 77.70
2022	in color	168K-22-2022	€ 68.00
2023	in color	168K-22-2023	€ 46.80
2024	in color	168K-22-2024	€ 71.40

CROATIAN REPUBLIC/HERCEG-BOSNA  
BOSNIA-HERZEGOVINA

2020		168BH-15-2020	€ 13.80
2021		168BH-15-2021	€ 13.80
2022		168BH-15-2022	€ 20.00
2023		168BH-15-2023	€ 15.00
2024		168BH-15-2024	€ 15.90

## CYPRUS

2020	in color	295-20-2020	€ 11.50
2021	in color	295-20-2021	€ 13.80
2022	in color	295-20-2022	€ 15.00
2023	in color	295-20-2023	€ 11.00
2024	in color	295-20-2024	€ 11.60
Turkish Cypriot Post			
2020	in color	298-19-2020	€ 5.00
2021	in color	298-19-2021	€ 10.00
2022	in color	298-19-2022	€ 5.50
2023	in color	298-19-2023	€ 5.50
2024	in color	298-19-2024	€ 5.80

## CZECH REPUBLIC

2020	in color	312-20-2020	€ 35.70
2021	in color	312-20-2021	€ 40.70
2022	in color	312-20-2022	€ 32.00
2023	in color	312-20-2023	€ 42.90
2024	in color	312-20-2024	€ 67.20

## D

DENMARK			
2020	in color	128-17-2020	€ 10.00
2021	in color	128-17-2021	€ 10.00
2022	in color	128-17-2022	€ 15.00
2023	in color	128-17-2023	€ 15.00
2024	in color	128-17-2024	€ 15.90

## E

ESTONIA			
2020		175-10-2020	€ 21.00
2021		175-10-2021	€ 21.00
2022	in color	175-22-2022	€ 21.70
2023	in color	175-22-2023	€ 20.00
2024	in color	175-22-2024	€ 21.20

## EUROPE SPECIAL TERRITORIES

Europe CEPT Issues of the former Yugoslavia			
2020		290JS-2020	€ 10.00
2021		290JS-2021	€ 10.00
2022		290JS-2022	€ 11.00
2023		290JS-2023	€ 11.00
2024		290JS-2024	€ 11.60

## Europe CEPT Joint Issues of EU Countries

2020	in color	290A-20-2020	€ 49.60
2021	in color	290A-20-2021	€ 40.70
2022	in color	290A-20-2022	€ 50.70
2023	in color	290A-20-2023	€ 42.90
2024	in color	290A-24-2024	€ 52.10

## Europe CEPT Sympathy Issues of non-EU Countries

2020	in color	290S-20-2020	€ 26.70
2021	in color	290S-20-2021	€ 37.00
2022	in color	290S-20-2022	€ 32.00
2023	in color	290S-20-2023	€ 27.60
2024	in color	290S-20-2024	€ 34.40

## Other Europe Issues and NORDEN

2020	in color	290M-16-2020	€ 13.80
2021	in color	290M-16-2021	€ 10.00
2022	in color	290M-16-2022	€ 11.00
2023	in color	290M-16-2023	€ 15.00
2024	in color	290M-16-2024	€ 11.60

## F

FALKLAND-ISLANDS AND DEPENDENCIES  
(SOUTH GEORGIA AND SOUTH SANDWICH  
ISLANDS)

2020	in color	410-17-2020	€ 25.20
2021	in color	410-17-2021	€ 25.20
2022	in color	410-17-2022	€ 23.00
2023	in color	410-17-2023	€ 28.00
2024	in color	410-17-2024	€ 30.10

## FAROE ISLANDS

2020	in color	128F-16-2020	€ 18.40
2021	in color	128F-16-2021	€ 21.00
2022	in color	128F-16-2022	€ 20.00
2023	in color	128F-16-2023	€ 23.00
2024	in color	128F-16-2024	€ 21.20

## Booklets

2020		128FH-2020	€ 10.00
2021		128FH-2021	€ 10.00
2022		128FH-2022	€ 11.00
2023		128FH-2023	€ 11.00
2024		128FH-2024	€ 11.60

FINLAND		
2020	in color	€ 26.60
2021	in color	€ 25.20
2022	in color	€ 27.60
2023	in color	€ 21.70
2024	in color	€ 21.20

FRANCE		
2020	in color	€ 75.50
2021	in color	€ 81.40
2022	in color	€ 87.50
2023	in color	€ 89.70
2024	in color	€ 98.30

Blocks		
2020	in color	€ 10.00
2021	in color	€ 13.80
2022	in color	€ 11.00
2023	in color	€ 15.00
2024	in color	€ 15.90

Blocs CNEP		
2020	in color	€ 5.00
2021	in color	€ 5.00
2022	in color	€ 5.50
2023	in color	€ 5.50
2024	in color	€ 5.80

Booklets		
2020	in color	€ 5.00
2021	in color	€ 5.00
2022	in color	€ 5.50
2023	in color	€ 15.00
2024	in color	€ 11.60

Official stamps Council of Europe		
2017-2024	in color	€ 5.80

Official stamps UNESCO		
2017-2024	in color	€ 5.80

Sheetlets		
2020	in color	€ 18.40
2021	in color	€ 18.40
2022	in color	€ 15.00
2023	in color	€ 15.00
2024	in color	€ 15.90

Souvenir blocks		
2020	in color	€ 25.20
2021	in color	€ 26.60
2022	in color	€ 28.00
2023	in color	€ 32.00
2024	in color	€ 29.40

Special pages for adhesive stamps		
2020	in color	€ 5.00
2021	in color	€ 5.00
2022	in color	€ 5.80
2023	in color	€ 5.80
2024	in color	€ 5.80

FRENCH ANTARCTIC TERRITORIES (TAAF)		
2020	in color	€ 30.40
2021	in color	€ 28.10
2022	in color	€ 28.00
2023	in color	€ 27.60
2024	in color	€ 29.40

FRENCH POLYNESIA		
2020	in color	€ 18.40
2021	in color	€ 18.40
2022	in color	€ 24.70
2023	in color	€ 20.00
2024	in color	€ 15.90

## G

GERMANY		
2020	in color	€ 35.70
2021	in color	€ 37.00
2022	in color	€ 39.00
2023	in color	€ 46.80
2024	in color	€ 43.70

Booklets		
2020	in color	€ 18.40
2021	in color	€ 13.80
2022	in color	€ 5.50
2023	in color	€ 11.00
2024	in color	€ 11.60

Booklets for the German Sports Aid		
2020	in color	€ 10.00
2021	in color	€ 10.00
2022	in color	€ 11.00
2023	in color	€ 11.00

Combinations		
2020	in color	€ 5.00
2021	in color	€ 5.00
2022	in color	€ 5.50
2023	in color	€ 5.50
2024	in color	€ 5.80

Commemorative pages		
2020	in color	€ 30.40
2021	in color	€ 30.40
2022	in color	€ 32.00
2023	in color	€ 27.60
2024	in color	€ 30.10

Definitive stamps		
2020-2021	in color	€ 5.00
2022	in color	€ 11.00
2023	in color	€ 5.50
2024	in color	€ 5.80

Pairs from sheets		
2020-2022	in color	€ 11.00

Self-adhesive panes		
2020	in color	€ 26.60
2021	in color	€ 45.90
2022	in color	€ 23.00
2023	in color	€ 39.00
2024	in color	€ 38.70

Sheets of 10 stamps		
2020	in color	€ 79.20
2020	in color	€ 81.40
2021	in color	€ 71.80
2021	in color	€ 88.80
2022	in color	€ 118.70
2022	in color	€ 113.10
2023	in color	€ 110.90
2023	in color	€ 105.30
2024	in color	€ 107.00
2024	in color	€ 117.60

Special prints for the German Sports Aid		
2020	in color	€ 10.00
2021	in color	€ 5.00
2022	in color	€ 5.50
2023	in color	€ 5.50

Stationery		
Philatelic Letter Stationary		
2020	in color	€ 5.00
2022	in color	€ 5.50
2023	in color	€ 15.00
2024	in color	€ 11.60

Postcards		
2020	in color	€ 5.00
2021	in color	€ 5.00
2022	in color	€ 5.50

Stationery		
2020	in color	€ 21.00
2021	in color	€ 26.60
2022	in color	€ 27.60
2023	in color	€ 23.00
2024	in color	€ 26.20

GIBRALTAR		
2020	in color	€ 21.00
2021	in color	€ 21.00
2022	in color	€ 27.60
2023	in color	€ 29.70
2024	in color	€ 34.40

GREAT BRITAIN		
2020	in color	€ 64.40
2021	in color	€ 62.90
2022	in color	€ 78.00
2023	in color	€ 91.40
2024	in color	€ 84.00

Booklets		
2020	in color	€ 25.20
2021	in color	€ 26.70
2022	in color	€ 27.60
2023	in color	€ 27.60
2024	in color	€ 21.20

GREECE		
2020	in color	€ 25.20
2021	in color	€ 26.60
2022	in color	€ 28.00
2023	in color	€ 24.70
2024	in color	€ 24.50

Booklets		
2018-2020	in color	€ 5.00
2021-2023	in color	€ 5.50

Sheetlets		
2020	in color	€ 5.00
2021	in color	€ 5.00
2022	in color	€ 5.50
2023	in color	€ 5.50
2024	in color	€ 5.80

GREENLAND		
2020	in color	€ 21.00
2021	in color	€ 28.10
2022	in color	€ 27.60
2023	in color	€ 27.60
2024	in color	€ 24.50

Booklets		
2020	in color	€ 5.00
2021	in color	€ 5.00
2022	in color	€ 11.00
2023	in color	€ 5.50
2024	in color	€ 5.80

GUERNSEY		
2020	in color	€ 26.60
2021	in color	€ 30.40
2022	in color	€ 27.60
2023	in color	€ 40.70
2024	in color	€ 30.10

## H

HONGKONG		
2020	in color	€ 57.00
2021	in color	€ 85.10
2022	in color	€ 62.40
2023	in color	€ 60.20
2024	in color	€ 100.80

HUNGARY		
2020	in color	€ 37.00
2021	in color	€ 37.00
2022	in color	€ 36.00
2023	in color	€ 39.00
2024	in color	€ 40.40

## I

ICELAND		
2020	in color	€ 13.80
2023	in color	€ 7.50

IRELAND		
2020	in color	€ 25.20
2021	in color	€ 21.00
2022	in color	€ 23.00
2023	in color	€ 23.00
2024	in color	€ 29.40

ISLE OF MAN		
2020	in color	€ 34.20
2021	in color	€ 37.00
2022	in color	€ 52.40
2023	in color	€ 46.80
2024	in color	€ 58.80

ISRAEL		
with tabs		
2020	in color	€ 21.00
2021	in color	€ 21.00
2022	in color	€ 24.70
2023	in color	€ 23.00
2024	in color	€ 24.50

Sheetlets		
2020	in color	€ 48.10
2021	in color	€ 34.20
2022	in color	€ 42.90
2023	in color	€ 62.40
2024	in color	€ 40.40

ITALY		
2020	in color	€ 51.80
2021	in color	€ 60.70
2022	in color	€ 58.50
2023	in color	€ 66.30
2024	in color	€ 98.30

## J

JERSEY		
2020	in color	€ 51.80
2021	in color	€ 55.50
2022	in color	€ 56.30
2023	in color	€ 54.60
2024	in color	€ 67.20

## K

KOSOVO, REPUBLIC		
2020	in color	€ 15.30
2021	in color	€ 21.00
2022	in color	€ 27.60
2023	in color	€ 23.00
2024	in color	€ 30.10

## L

LATVIA		
2020	176-10-2020	€ 13.80
2021	176-10-2021	€ 18.40
2022	176-10-2022	€ 23.00
2023	in color 176-23-2023	€ 21.70
2024	in color 176-23-2024	€ 21.20

LIECHTENSTEIN		
2020	178-15-2020	€ 21.00
2021	178-15-2021	€ 25.20
2022	178-15-2022	€ 27.60
2023	in color 178-23-2023	€ 24.70
2024	in color 178-23-2024	€ 29.40

LITHUANIA		
2020	in color 177-20-2020	€ 15.30
2021	in color 177-20-2021	€ 13.80
2022	in color 177-20-2022	€ 15.00
2023	in color 177-20-2023	€ 15.00
2024	in color 177-20-2024	€ 15.90

LUXEMBOURG		
2020	in color 181-16-2020	€ 18.40
2021	in color 181-16-2021	€ 18.40
2022	in color 181-16-2022	€ 23.00
2023	in color 181-16-2023	€ 23.00
2024	in color 181-16-2024	€ 24.50
Booklets		
2013-2020	181H-2021	€ 10.00
2022-2024	181H-2024	€ 5.80

## M

MACAO		
2020	in color 161-19-2020	€ 55.50
2021	in color 161-19-2021	€ 55.50
2022	in color 161-22-2022	€ 64.10
2023	in color 161-22-2023	€ 39.00
2024	in color 161-22-2024	€ 50.40

MADEIRA		
2020	224-08-2020	€ 10.00
2021	224-08-2021	€ 10.00
2022	224-08-2022	€ 11.00
2023	224-08-2023	€ 11.00
2024	224-08-2024	€ 11.60

Sheetlets		
2020	224K-2020	€ 5.00
2021	224K-2021	€ 5.00
2022	224K-2022	€ 5.50
2023	224K-2023	€ 5.50
2024	224K-2024	€ 5.80

MALTA		
2020	in color 184-18-2020	€ 21.00
2021	in color 184-18-2021	€ 21.00
2022	in color 184-18-2022	€ 28.00
2023	in color 184-18-2023	€ 27.60
2024	in color 184-18-2024	€ 24.50

MALTESE ORDER, SOVEREIGN		
2020	in color 183-20-2020	€ 49.60
2021	in color 183-20-2021	€ 44.40
2022	in color 183-20-2022	€ 39.00
2023	in color 183-20-2023	€ 32.00
2024	in color 183-20-2024	€ 34.40

MARSHALL ISLANDS		
2020	in color 515-19-2020	€ 85.10
2021	in color 515-21-2021	€ 100.80

MONACO		
2020	in color 186-17-2020	€ 21.00
2021	in color 186-17-2021	€ 25.20
2022	in color 186-17-2022	€ 27.60
2023	in color 186-17-2023	€ 36.00
2024	in color 186-24-2024	€ 36.10

MONTENEGRO		
2020	170-2020	€ 10.00
2021	170-2021	€ 10.00
2022	170-2022	€ 11.00
2023	170-2023	€ 15.00
2024	in color 170-24-2024	€ 13.30

## N

NAMIBIA		
2020	510-15-2020	€ 10.00
2021	510-15-2021	€ 5.00
2022	510-15-2022	€ 5.50
2023	510-15-2023	€ 5.50
2024	510-15-2024	€ 11.60

NEPAL		
2020	in color 188-17-2020	€ 13.80
2021	in color 188-17-2021	€ 13.80
2022	in color 188-17-2022	€ 15.00
2023	in color 188-17-2023	€ 5.50
2024	in color 188-17-2024	€ 11.60

NETHERLANDS		
2020	in color 191-18-2020	€ 40.70
2021	in color 191-18-2021	€ 37.00
2022	in color 191-22-2022	€ 40.70
2023	in color 191-22-2023	€ 42.90
2024	in color 191-22-2024	€ 50.40

Booklets		
2020	191H-14-2020	€ 13.80
2021	191H-14-2021	€ 13.80
2022	191H-14-2022	€ 15.00
2023	191H-14-2023	€ 15.00
2024	191H-14-2024	€ 15.90

Sheetlets		
2020	in color 191K-19-2020	€ 37.00
2021	in color 191K-19-2021	€ 34.20
2022	in color 191K-19-2022	€ 36.00
2023	in color 191K-19-2023	€ 39.00
2024	in color 191K-19-2024	€ 34.40

NEW CALEDONIA		
2020	446-10-2020	€ 10.00
2021	446-10-2021	€ 10.00
2022	446-10-2022	€ 11.00
2023	446-10-2023	€ 11.00
2024	446-10-2024	€ 15.90

NEW ZEALAND		
2020	in color 495-20-2020	€ 57.00
2021	in color 495-20-2021	€ 59.20
2022	in color 495-20-2022	€ 58.50
2023	in color 495-23-2023	€ 75.80
2024	in color 495-23-2024	€ 58.80

NORFOLK-ISLAND		
2020	473-13-2020	€ 13.80
2021	473-13-2021	€ 13.80
2022	473-13-2022	€ 11.00
2023	473-13-2023	€ 11.00
2024	473-13-2024	€ 11.60

NORWAY		
2020	195-11-2020	€ 18.40
2021	195-11-2021	€ 13.80
2022	195-11-2022	€ 20.00
2023	195-11-2023	€ 15.00
2024	195-11-2024	€ 21.20

## O

OMAN		
2020	in color 182-20-2020	€ 42.20
2021	in color 182-20-2021	€ 51.80
2022	in color 182-20-2022	€ 58.50
2023	in color 182-20-2023	€ 32.00
2024	in color 182-24-2024	€ 81.50

## P

PALESTINE		
2020	504-14-2020	€ 11.00
2022	504-14-2022	€ 5.50
2023	504-14-2023	€ 32.00

PAPUA NEW GUINEA		
2020	in color 476-18-2020	€ 26.60
2021	in color 476-18-2021	€ 11.00

PITCAIRN ISLANDS		
2020	in color 477-18-2020	€ 5.00
2021	in color 477-18-2021	€ 5.00
2022	in color 477-18-2022	€ 5.50
2023	in color 477-18-2023	€ 5.50
2024	in color 477-18-2024	€ 5.80

POLAND		
2020	in color 218-19-2020	€ 55.50
2021	in color 218-19-2021	€ 37.00
2022	in color 218-19-2022	€ 54.60
2023	in color 218-23-2023	€ 68.00
2024	in color 218-23-2024	€ 46.20

PORTUGAL		
2020	in color 220-20-2020	€ 57.00
2021	in color 220-20-2021	€ 51.80
2022	in color 220-20-2022	€ 50.70
2023	in color 220-23-2023	€ 56.30
2024	in color 220-23-2024	€ 63.00

Sheetlets		
2020	220K-08-2020	€ 5.00
2021	220K-08-2021	€ 5.00

2022	220K-08-2022	€ 11.00
2023	220K-08-2023	€ 5.50
2024	220K-08-2024	€ 5.80

Vending machine stamps		
2020	220A-13-2020	€ 25.20
2021	in color 220A-21-2021	€ 26.70
2022	in color 220A-21-2022	€ 27.60
2023	in color 220A-21-2023	€ 27.60
2024	in color 220A-21-2024	€ 29.40

## R

ROSS DEPENDENCY		
2020	496-2020	€ 5.00
2021	496-2021	€ 5.00
2022	496-2022	€ 5.50
2023	496-2023	€ 5.50
2024	496-2024	€ 5.80

RUSSIA, REPUBLIC		
2020	in color 241-19-2020	€ 88.80
2021	in color 241-21-2021	€ 86.60
2022	in color 241-21-2022	€ 105.30
2023	in color 241-23-2023	€ 81.20
2024	in color 241-24-2024	€ 86.80

## S

SAN MARINO		
2020	in color 250-17-2020	€ 25.20
2021	in color 250-17-2021	€ 18.40
2022	in color 250-17-2022	€ 27.60
2023	in color 250-17-2023	€ 23.00
2024	in color 250-17-2024	€ 24.50

SERBIA		
2020	in color 196-16-2020	€ 26.60
2021	in color 196-16-2021	€ 44.40
2022	in color 196-22-2022	€ 48.50
2023	in color 196-22-2023	€ 46.80
2024	in color 196-22-2024	€ 42.00

SLOVAKIAN REPUBLIC		
2020	in color 313-19-2020	€ 25.20
2021	in color 313-19-2021	€ 25.20
2022	in color 313-19-2022	€ 23.00
2023	in color 313-19-2023	€ 23.00
2024	in color 313-19-2024	€ 29.40

SLOVENIA		
2020	in color 169-19-2020	€ 30.40
2021	in color 169-19-2021	€ 26.60
2022	in color 169-19-2022	€ 28.00
2023	in color 169-19-2023	€ 27.60
2024	in color 169-19-2024	€ 30.10

Sheetlets		
2020	in color 169K-19-2020	€ 34.20
2021	in color 169K-19-2021	€ 44.40
2022	in color 169K-19-2022	€ 36.00
2023	in color 169K-19-2023	€ 36.00
2024	in color 169K-24-2024	€ 52.10

SOUTH AFRICA		
2020	508-15-2020	€ 18.40
2021	508-15-2021	€ 5.00

SPAIN		
2020	in color 272-20-2020	€ 82.90
2021	in color 272-20-2021	€ 81.40
2022	in color 272-22-2022	€ 87.50
2023	in color 272-22-2023	€ 85.80
2024	in color 272-24-2024	€ 81.50

Special pages		
2020	272S-2020	€ 18.40
2021	272S-2021	€ 21.00
2022	272S-2022	€ 23.00
2023	272S-2023	€ 20.00
2024	272S-2024	€ 29.40

ST. PIERRE AND MIQUELON		
2020	448-08	

SWITZERLAND			
2020	in color	260-17-2020	€ 30.40
2021	in color	260-17-2021	€ 30.40
2022	in color	260-17-2022	€ 50.70
2023	in color	260-23-2023	€ 40.70
2024	in color	260-23-2024	€ 34.40
Blocks of Four			
2020	in color	262-20-2020	€ 35.70
2021	in color	262-20-2021	€ 40.70
2022	in color	262-20-2022	€ 46.80
2023	in color	262-20-2023	€ 39.00
2024	in color	262-24-2024	€ 52.10
Booklets „Pro Juventute“			
2019-			
2021		261H-80-2021	€ 5.00
2024		261H-80-2024	€ 11.60
Booklets-Definitives and „Pro Patria“			
2021		260H-79-2021	€ 5.00
2022		260H-79-2022	€ 15.00
2023		260H-79-2023	€ 5.50
2024		260H-79-2024	€ 11.60
Combinations			
2020		260Z-13-2020	€ 18.40
2021		260Z-13-2021	€ 13.80
2024		260Z-13-2024	€ 11.60
Sheetlets			
2020		260K-13-2020	€ 37.00
2021	in color	260K-21-2021	€ 28.10
2022	in color	260K-21-2022	€ 42.90
2023	in color	260K-21-2023	€ 32.00
2024	in color	260K-21-2024	€ 34.40

## U

UKRAINE			
2020	in color	243-20-2020	€ 42.20
2021	in color	243-20-2021	€ 48.10
2022	in color	243-20-2022	€ 32.00
2023	in color	243-20-2023	€ 28.00
2024	in color	243-20-2024	€ 50.40

UNITED ARAB EMIRATES			
2020		154-13-2020	€ 21.00
2021		154-13-2021	€ 44.40
2022	in color	154-22-2022	€ 40.70
2023	in color	154-22-2023	€ 42.90
2024	in color	154-22-2024	€ 38.70

UNITED NATIONS GENEVA			
2020		265-13-2020	€ 18.40
2021		265-13-2021	€ 21.00
2022		265-13-2022	€ 20.00
2023	in color	265-23-2023	€ 24.70
2024	in color	265-23-2024	€ 21.20
Booklets			
2020		265H-2020	€ 5.00
2021		265H-2021	€ 5.00
2022		265H-2022	€ 5.50
2023		265H-2023	€ 5.50
2024		265H-2024	€ 5.80
Sheetlets and se-tenant sheetlets			
2020		265K-08-2020	€ 13.80
2021		265K-08-2021	€ 21.00
2022	in color	265K-22-2022	€ 29.70
2023	in color	265K-22-2023	€ 28.00
2024	in color	265K-22-2024	€ 30.10

UNITED NATIONS NEW YORK			
2020	in color	600-19-2020	€ 26.60
2021	in color	600-19-2021	€ 26.60
2022	in color	600-19-2022	€ 23.00
2023	in color	600-19-2023	€ 23.00
2024	in color	600-19-2024	€ 24.50
„Flag Series“ Combinations			
2020		601Z-2020	€ 10.00
2024		601Z-2024	€ 5.80
„Flag Series“ Sheetlets			
2020		600S-01-2020	€ 10.00
2024		600S-01-2024	€ 5.80
„Flag Series“ stamps and sheets			
2020		601-97-2020	€ 10.00
2024		601-97-2024	€ 5.80
Booklets			
2020		600H-2020	€ 5.00
2021		600H-2021	€ 5.00
2022		600H-2022	€ 5.50
2023		600H-2023	€ 5.50
2024		600H-2024	€ 5.80
Sheetlets and se-tenant sheetlets			
2020		600K-14-2020	€ 26.60
2021		600K-14-2021	€ 30.40
2022	in color	600K-22-2022	€ 37.70
2023	in color	600K-22-2023	€ 28.00
2024	in color	600K-22-2024	€ 30.10

UNITED NATIONS VIENNA			
2020		605-14-2020	€ 18.40
2021		605-14-2021	€ 25.20
2022	in color	605-22-2022	€ 21.70
2023	in color	605-22-2023	€ 20.00
2024	in color	605-22-2024	€ 24.50
Booklets			
2020		605H-2020	€ 5.00
2021		605H-2021	€ 5.00
2022		605H-2022	€ 5.50
2023		605H-2023	€ 5.50
2024		605H-2024	€ 5.80
Sheetlets and se-tenant sheetlets			
2020	in color	605K-19-2020	€ 18.40
2021	in color	605K-19-2021	€ 25.20
2022	in color	605K-19-2022	€ 28.00
2023	in color	605K-19-2023	€ 15.00
2024	in color	605K-19-2024	€ 34.40

USA			
Booklets and self-adhesive panes			
2020		512R-09-2020	€ 10.00
2021		512R-09-2021	€ 10.00
2022		512R-09-2022	€ 11.00
2023		512R-09-2023	€ 11.00
2024		512R-09-2024	€ 11.60
Reg. Issues, Commemoratives and Air mails			
2020		512-15-2020	€ 26.60
2021		512-15-2021	€ 26.60
2022	in color	512-22-2022	€ 33.70
2023	in color	512-22-2023	€ 36.00
2024	in color	512-22-2024	€ 34.40

## V

VATICAN			
2020	in color	172-16-2020	€ 21.00
2021	in color	172-16-2021	€ 21.00
2022	in color	172-16-2022	€ 27.60
2023	in color	172-16-2023	€ 27.60
2024	in color	172-16-2024	€ 24.50

WALLIS AND FUTUNA ISLANDS			
2020	in color	444-20-2020	€ 6.50
2021	in color	444-20-2021	€ 10.00
2022	in color	444-20-2022	€ 11.00
2023	in color	444-20-2023	€ 11.00
2024	in color	444-20-2024	€ 11.60

## LINDNER DOUBLE-T SUPPLEMENTS

AUSTRIA			
2020	in color	dT209-17-2020	€ 52.50
2021	in color	dT209-17-2021	€ 49.00
2022	in color	dT209-22-2022	€ 53.70
2023	in color	dT209-22-2023	€ 46.80
2024	in color	dT209-22-2024	€ 56.00

Sheetlets			
2020		dT209K-15-2020	€ 39.20
2021		dT209K-15-2021	€ 39.20
2022	in color	dT209K-22-2022	€ 43.30
2023	in color	dT209K-22-2023	€ 41.60
2024	in color	dT209K-22-2024	€ 50.40

GERMANY			
2020	in color	dT120B-20-2020	€ 45.60
2021	in color	dT120B-20-2021	€ 49.00
2022	in color	dT120B-20-2022	€ 52.00
2023	in color	dT120B-20-2023	€ 62.40
2024	in color	dT120B-24-2024	€ 57.70

SWITZERLAND			
2020	in color	dT260-17-2020	€ 39.20
2021	in color	dT260-17-2021	€ 39.20
2022	in color	dT260-17-2022	€ 67.60
2023	in color	dT260-23-2023	€ 53.70
2024	in color	dT260-23-2024	€ 44.80



**MICHEL**  
Seit über 100 Jahren

Sammeln  
battenberg  
bayerland

Schweizer  
Briefmarken  
Katalog

Zumstein

AUSTRIA NETTO  
KATALOGE

EDITION  
**M&S**  
MÜNZEN & SAMMELN

# LITERATURE FOR COLLECTORS

LINDNER - our company offers a large selection of literature from many different publishers.

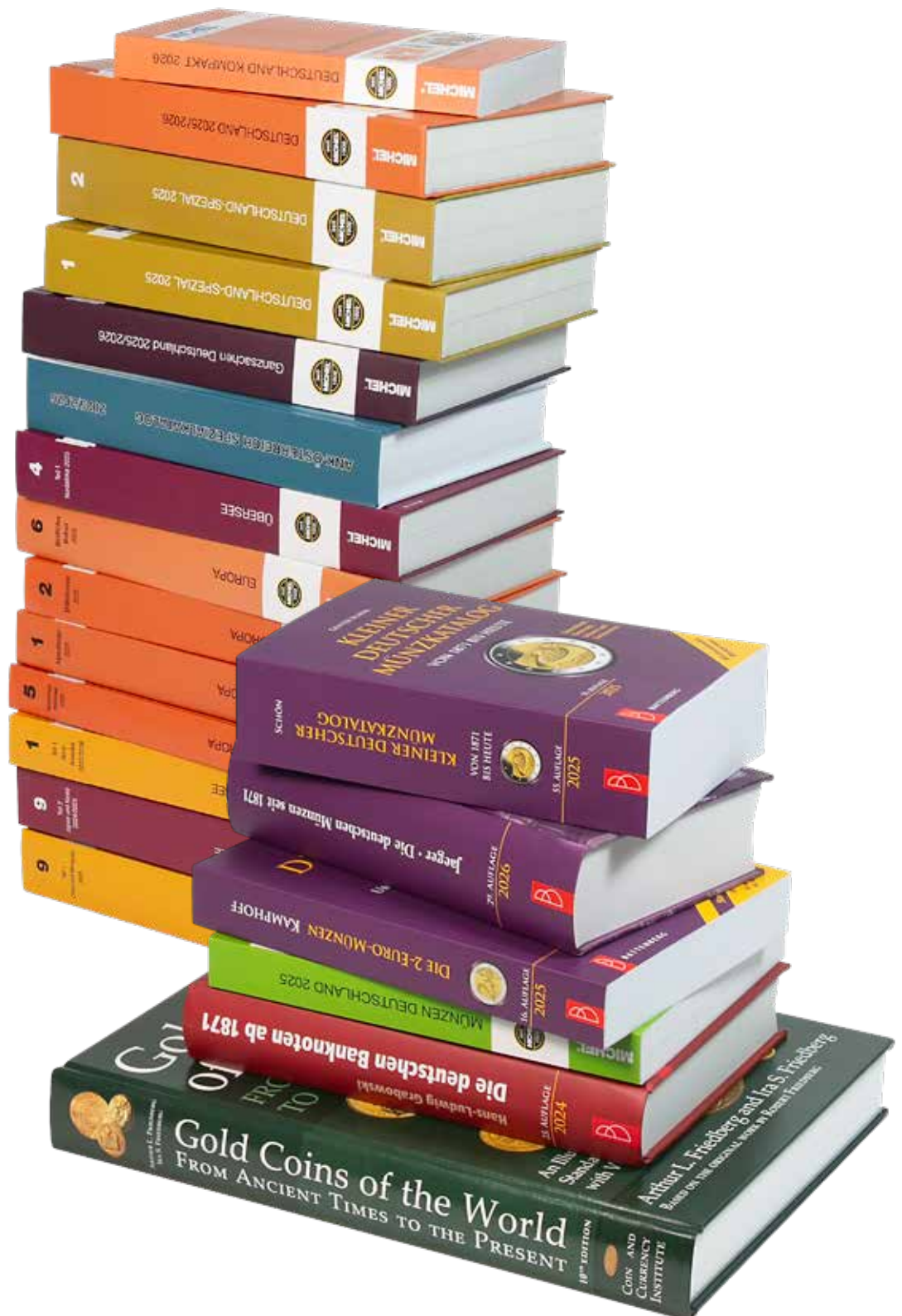

A bibliography can be requested free of charge.

📄 905K (in German)

# LINDNER

*Das Original*



Nr. 120 0

Made in  
Germany

15